



# User Guide | Version 10

Updated on 1/23/2019

Authored by Dave Hansen & Aaron Watts

---

# Table of Contents

Overview .....	6
Key Features .....	7
Managing Jobs .....	8
Creating a New Job.....	9
Opening an Existing Job.....	12
Creating a SwiftJob.....	13
Page Management.....	16
Setting the Scale.....	16
Setting the Scale Automatically.....	17
Setting the Scale Manually.....	19
Renaming Pages .....	23
Renaming Individual Pages .....	23
Batch Renaming Multiple Pages.....	24
Importing Additional Pages .....	26
Creating Folders for Pages.....	30
Adjusting the Page or Folder Order .....	31
Managing Page Tabs.....	33
Opening and Closing Tabbed Pages .....	33
Undocking a Tabbed Page.....	34
Performing Basic Takeoffs.....	36
Creating New Takeoff Items .....	36
Area Takeoff .....	36
Linear Takeoff.....	40
Segment Takeoff.....	43
Count Takeoff .....	45
Creating a New Section of a Takeoff Item.....	47
Creating a New Section using the New Section button .....	47
Creating a New Section on a Different Page Using Continue With .....	49
Subtracting from Sections.....	51

---

Subtracting Using Point-to-Point (P2P) .....	51
Subtracting Using Box .....	53
Copying and Pasting Takeoff Items .....	54
Copying and Pasting One or More Takeoff Items .....	54
Using Linear Copy to Paste Takeoff Items in a Specified Direction .....	56
Manipulating Points.....	58
Using Snap, Ortho, Freehand, and Verify Points.....	58
Using Snap .....	58
Using Ortho.....	60
Using Freehand .....	61
Using Verify Points .....	63
Moving Points .....	64
Moving a Takeoff Item .....	65
Moving Takeoff Items to a Specified Location .....	65
Moving Items with the Mouse .....	66
Moving Items Using the Right-Click Menu's Move Selection .....	66
Establishing Points While in Digitizer Record Mode .....	67
Creating Arcs with Areas, Linears, and Segments. ....	67
Area Arc.....	68
Linear and Segment Arcs .....	71
Creating Closed Circles with Areas and Linears.....	71
Creating Annotations .....	73
Adding and Specifying Dimensions .....	73
Adding Dimensions .....	74
Specifying Dimensions .....	75
Adding Notes.....	76
Showing a Legend.....	78
Adding Revision Clouds, Rubber Stamps, Sticky Tabs, Highlights, and Images .....	79
Adding Revision Clouds.....	79
Adding Rubber Stamps .....	80
Adding Sticky Tabs .....	81
Adding Highlights.....	82

---

Adding an Image to a Page .....	83
Adding an Overlay of a Page.....	84
Accessing Specialty Takeoff Items .....	89
Single-Click Area Takeoff .....	89
Single-Click Linear and Count Takeoffs .....	92
Roof Area Takeoff.....	93
Price Per SQ FT Area Takeoff .....	97
Area Cubic Yards Takeoff.....	101
Grid Tool Area Takeoff.....	104
Joist Tool Area Takeoff .....	109
Shortcuts and Hotkeys .....	120
Shortcuts for Zooming, Panning, and Navigating Pages .....	120
Zooming.....	120
Panning.....	121
Navigating Pages.....	122
Using and Customizing Keyboard Hotkeys.....	123
Integration with Excel .....	124
PlanSwift Ribbon-bar Tab .....	124
Connecting to and Disconnecting PlanSwift from Excel .....	125
Initiating PlanSwift Takeoffs from Excel .....	126
Adding New Sections to Takeoffs .....	128
Navigating from Excel Takeoff Values to PlanSwift Takeoff Values .....	129
Assigning Multiple Properties to a Takeoff Using 'Select Existing Item' .....	131
Right-Click Menu .....	134
Unlinking a Job .....	135
Customizing PlanSwift.....	136
Templates Overview .....	136
Key Features of the Templates Tab .....	142
Creating and Organizing Templates .....	142
Modifying Templates .....	145
Exporting and Importing.....	149
Parts Overview .....	151

---

How to Copy and Paste Parts.....	151
How to Drag and Drop Parts.....	156
Assemblies Overview .....	158
How to Copy and Paste an Assembly.....	158
Estimating Overview .....	162
Manipulating an Estimating Layout .....	164
Exporting Estimating Data to Excel .....	165
Reports Overview.....	167
Basic Report Engine.....	168
Report Designer .....	174
Plugins Overview.....	179
Advanced Features Overview.....	180
Page Tab.....	180
Tools Tab.....	183
View Tab.....	190
Lists Tab .....	194
Settings Tab.....	197
Customizing the Interface.....	197
Configuring Language and Measurement Type Defaults.....	207
Managing Data Storage .....	208
Right-Click Menus.....	209
Developer Overview.....	219
Managing PlanSwift Licenses .....	226
Activation and How Licenses Work .....	226
Activating PlanSwift.....	227
Removing a PlanSwift License.....	229
Automatically Removing a PlanSwift License .....	230
Re-activating, Removing, and Deleting Plugin Licenses.....	231
My Account.....	232
FAQ.....	234

---

# Overview

This guide will teach you how to use the tools and features found within PlanSwift® Takeoff and Estimating Software. All users must agree to accept and abide by the End User License Agreement, which can be found at [www.PlanSwift.com](http://www.PlanSwift.com). This guide is not meant to be a step-by-step “walk through” document, although it can be used as a reference for getting the work done.

This guide consists of four sections. The first section is Key Features, which covers managing jobs and pages, creating takeoffs and annotations, using shortcuts and hotkeys, and integrating with Excel. The second section is Customizing PlanSwift, which covers using templates, parts, and assemblies, estimating, creating reports, installing plugins, and using some of the advanced features. The third section is Managing PlanSwift Licenses, which covers activations and how licenses work. The fourth section is FAQ, which covers frequently asked questions.

PlanSwift also provides a [knowledgebase](#) and [videos](#) in addition to this User Guide.

If you encounter technical difficulties, consult this guide (including the [FAQ](#) section of this user manual) or contact the technical support department at:

PlanSwift® Technical Support

[support@PlanSwift.com](mailto:support@PlanSwift.com)

1-888-752-6794 Ext. 2

PlanSwift also offers additional training. For training options, contact the training department at:

PlanSwift® Training Department

[training@PlanSwift.com](mailto:training@PlanSwift.com)

1-888-752-6794 Ext. 4

---

## Key Features

PlanSwift Professional is an easy-to-use software platform due to its user-friendly interface and features. The instructions in this section will guide new users through the basics of starting a job, managing pages, performing takeoffs, creating annotations and overlays, using specialty takeoff items, using shortcuts and hotkeys, and integrating with Excel. We highly recommend purchasing a training package for accelerated learning and faster customization.

The PlanSwift Professional UI/UX utilizes the Windows Ribbon framework. Similar in functionality and appearance to the Microsoft Office 2007 Fluent user interface, the Ribbon framework is composed of a ribbon command bar that exposes the major features of PlanSwift Professional through a series of tabs at the top of the application window and a right-click context menu system.

PlanSwift Professional utilizes sidebars on the left and right sides of the main application window. These sidebars can be resized, reordered, collapsed, or undocked to maximize working space within the main application window.

PlanSwift Professional frequently utilizes “split buttons” inside the ribbon command bar: these are a composite control from which the user can select a primary feature from an upper button or select one of multiple secondary features from a drop-down list below.

# Managing Jobs

At the very top left corner of the PlanSwift window, you'll see what is referred to as the **PlanSwift Button**, which has the PlanSwift logo on it (Fig. 1-A).

1. Clicking on the **PlanSwift Button** gives you quick access to PlanSwift's job management tools:
  - Creating a New Job
  - Opening a Job
  - Printing a Job
  - Job Properties
  - Reloading a Job
  - Importing Jobs and Templates
  - Closing a Job
  - Exiting PlanSwift.
2. On the right side, it also provides a list of **Recent Documents**.

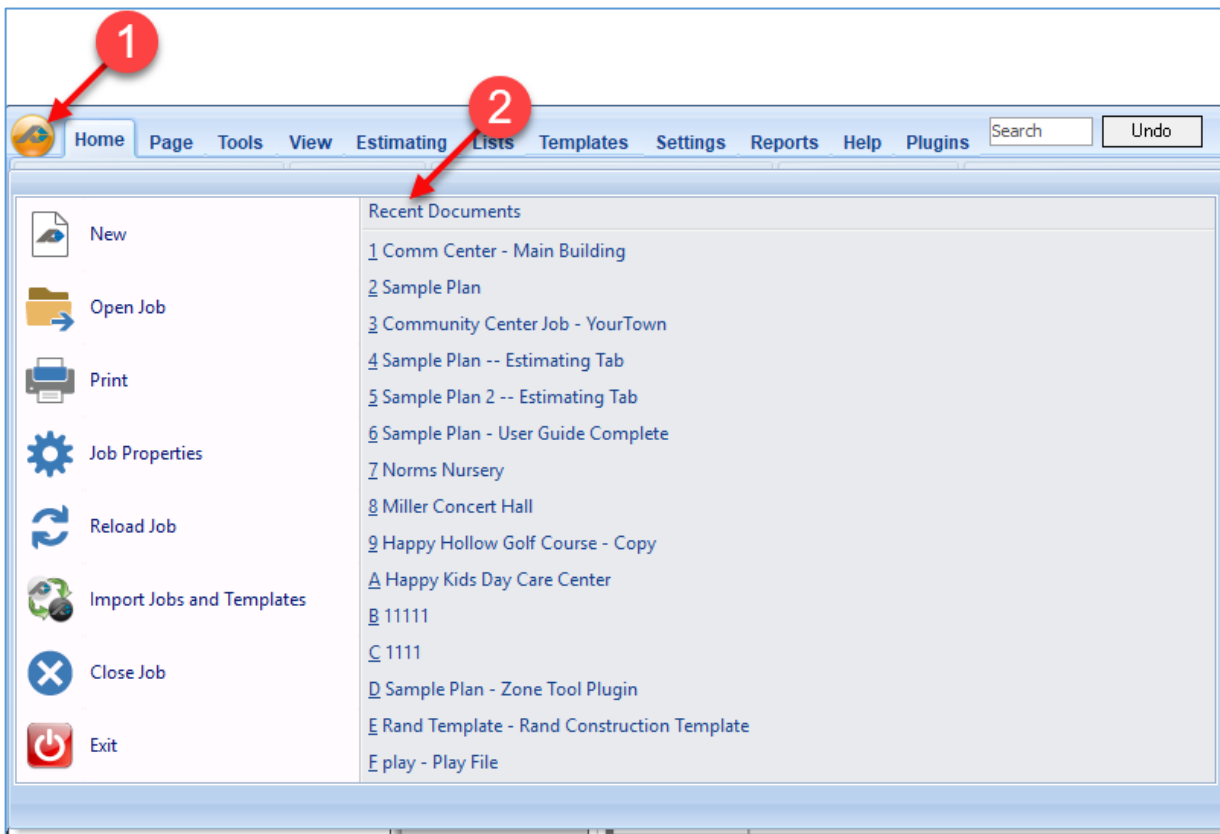

Figure 1-A



## Creating a New Job

To create a new job:

1. To create a new job in PlanSwift, click on the **New** button in the **Job Group** of the **Home** tab ribbon-bar (Fig. 1-B).
2. This opens a **New Job** dialog.
3. Enter a **Job/Quote #**.
4. Enter a description in the **Description** field.
5. Select the **New Job Location**.
6. Select the **Measurement Type**.
7. Click on **Next** to continue the dialog.

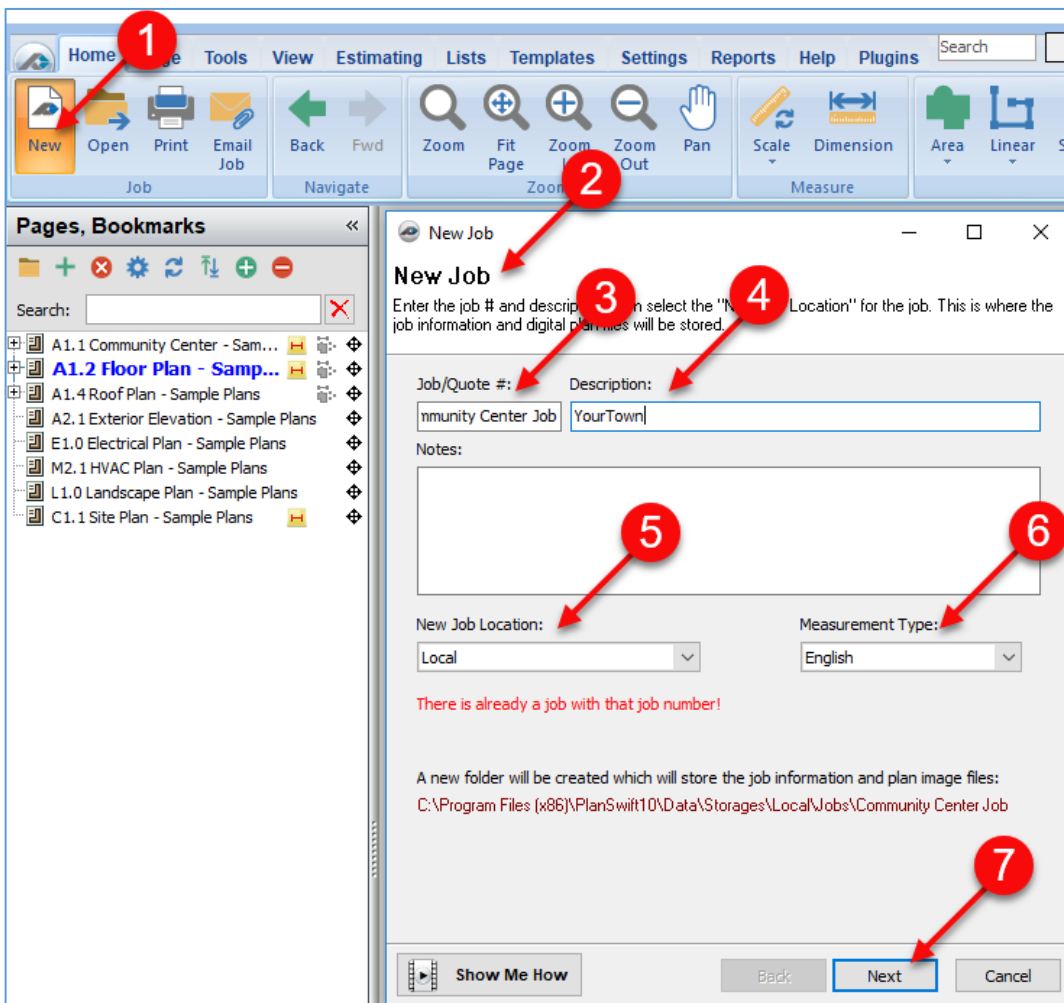

Figure 1-B

The next three dialog boxes and the **Browse For Folder** window shown in Figure 1-C allow you to select the image files, change any conversion settings, and then create the new job.

8. Click on **Browse** to open the **Browse For Folder** window
9. Navigate to and select the folder where your plans are located. Your plan files could be stored either locally or on a network.
10. After clicking on **Ok**, the pages may be selected by clicking on the checkboxes
11. If you want all of them, click on **Check All**.
12. Click on **Next**.

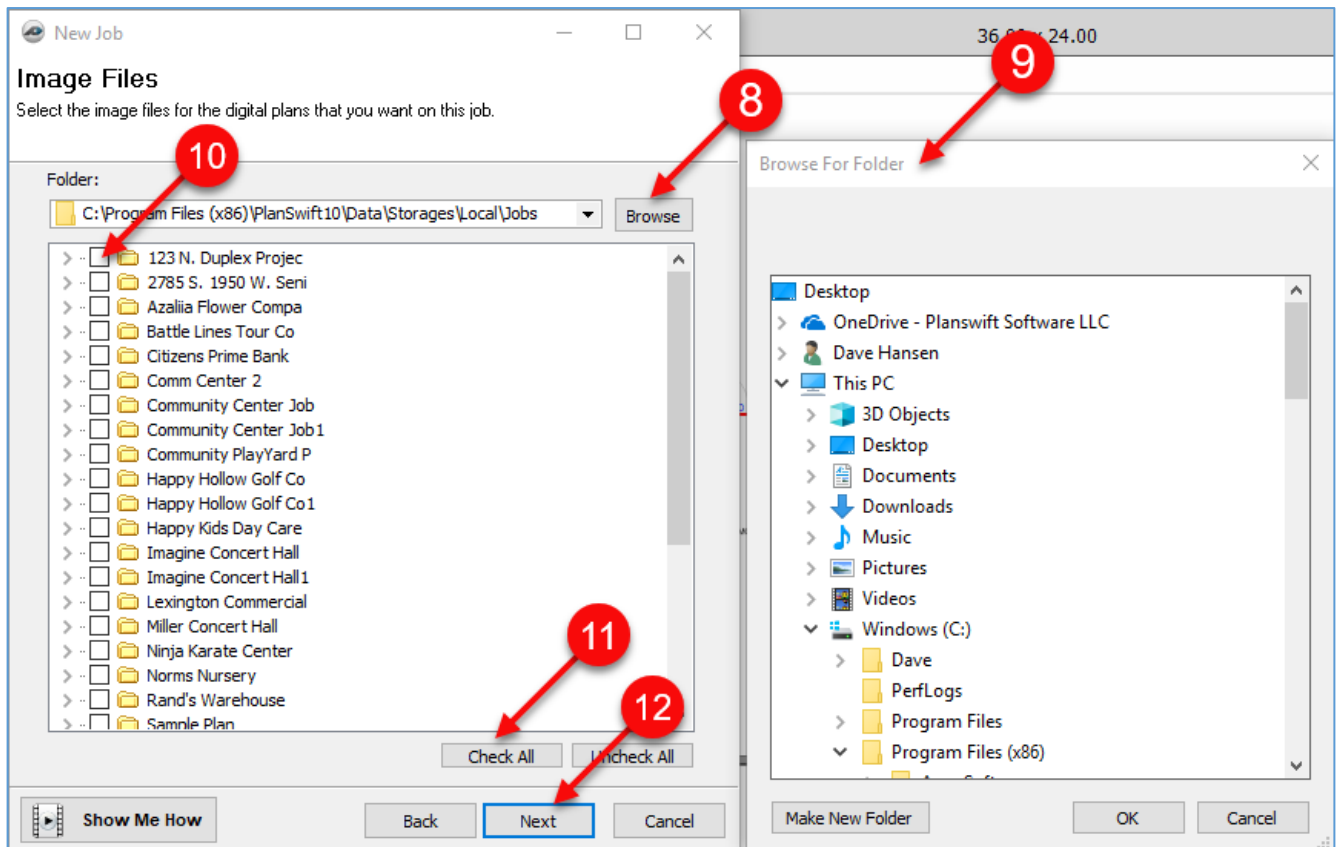

Figure 1-C

13. The **Convert Settings** dialog window allows for the selection of conversion settings (Fig. 1-D).

14. Select any settings you want and click on **Next**.

15. Click on **Finish** in the **Ready to Create Job** dialog window to create the job. This will load the job's pages that you selected earlier.

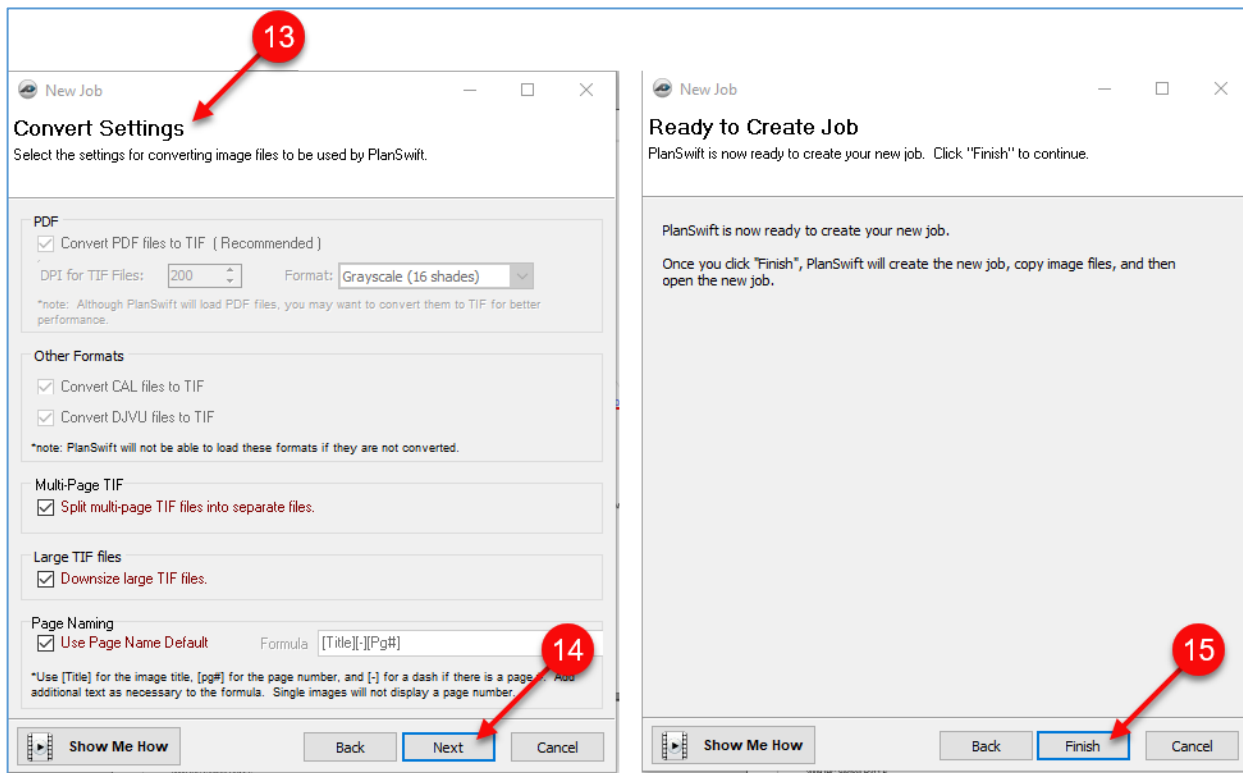

Figure 1-D

16. Figure 1-E shows the name of the job at the top of the **Main** menu ribbon-bar.

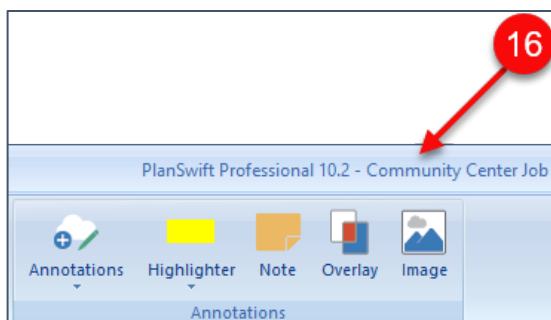

Figure 1-E

As you perform takeoffs on the Community Center job plans in PlanSwift, those takeoffs are automatically saved. When you close PlanSwift and then reopen it, the last job you were working on is automatically opened.

## Opening an Existing Job

To open an existing job:

1. Click on the **Open** button on the PlanSwift **Main** menu ribbon-bar (see Fig. 1-F).
2. This will open the **Open Job** window.
3. Scroll to and click on the job you wish to open.
4. If you have a long list of jobs and know the name of the job, type the job's name into the **Search** field, and the jobs with that name will be displayed.
5. After selecting the job, click on **Open Job** to open the job.

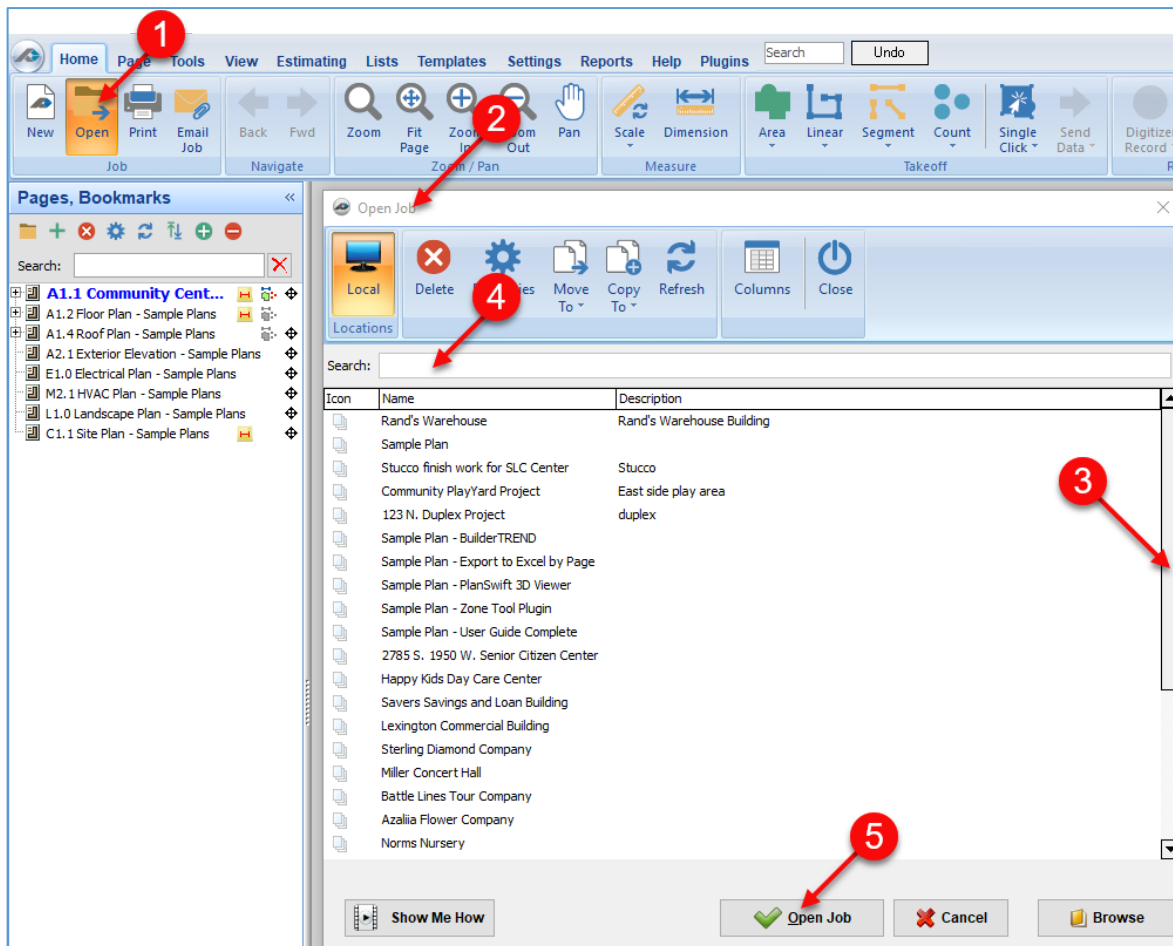

Figure 1-F

## Creating a SwiftJob

Jobs in PlanSwift can be saved and compressed by “zipping” them into a single file. **ZIP** is an archive **file** format that supports lossless data compression. PlanSwift replaces the typical **.zip** extension with a **.SwiftJob** extension for easy identification and portability or for backup. The data that is saved includes all plan pages, takeoff data, notes, bookmarks, attachments, and other data critical to the job. Zipping a **SwiftJob** is equivalent to a “**Save As**” function: zipping a job does not remove (or delete) the job from PlanSwift. To create a SwiftJob:

1. Click on **Zip SwiftJob** (Fig. 1-G).
2. Navigate to the location where the file is to be saved.
3. Give the zipped file a **File Name**.
4. Click on **Save** to zip the job.

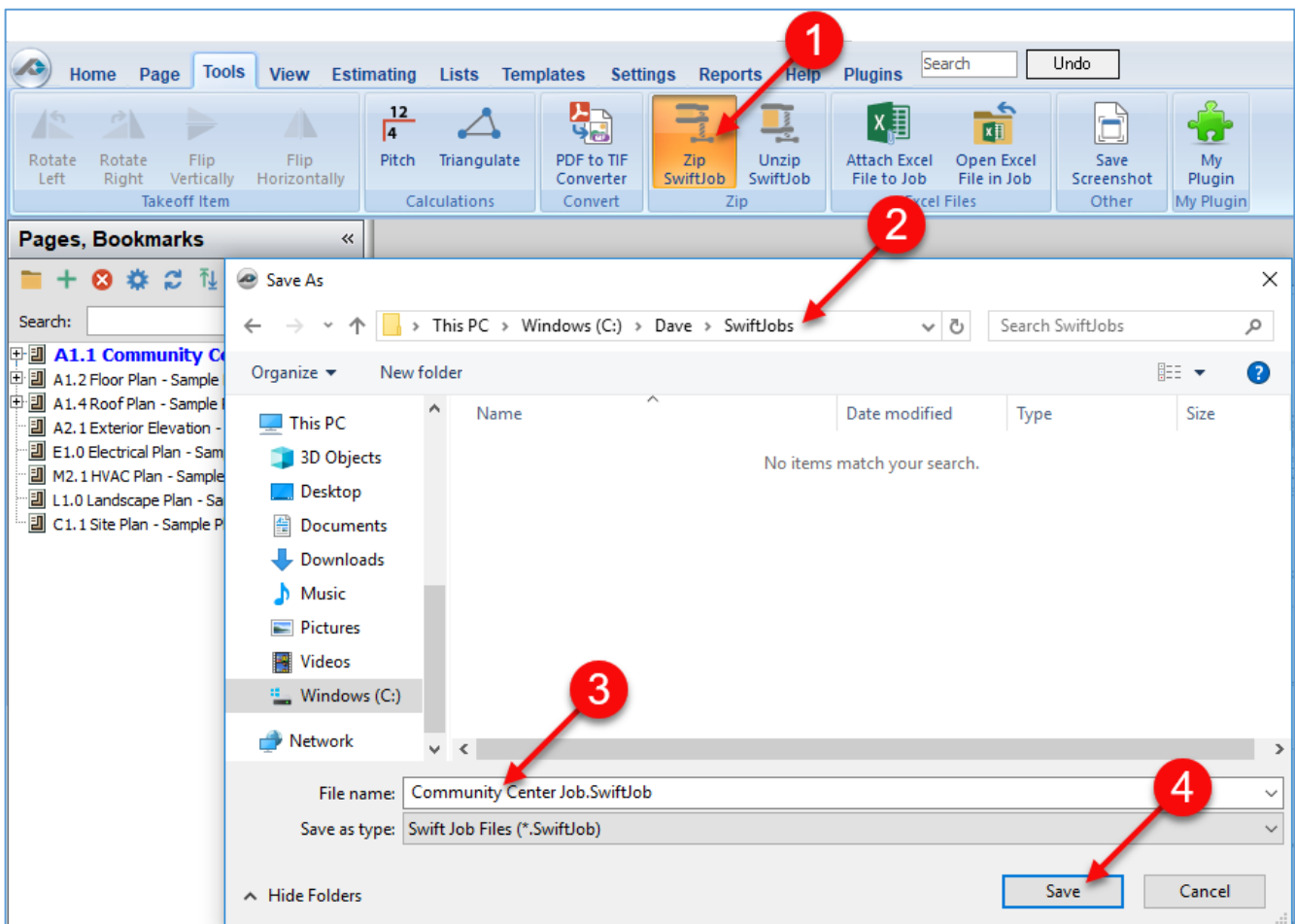

Figure 1-G

The **Unzip SwiftJob** button allows the zipped files to be unzipped into PlanSwift. To unzip a SwiftJob:

1. Click on **Unzip SwiftJob** (Fig. 1-H).
2. Navigate to the location where the zipped file is located.
3. After clicking on the file to be restored, its name will appear here.
4. Click on **Open**, and the file will be unzipped. A status bar will show the progress.

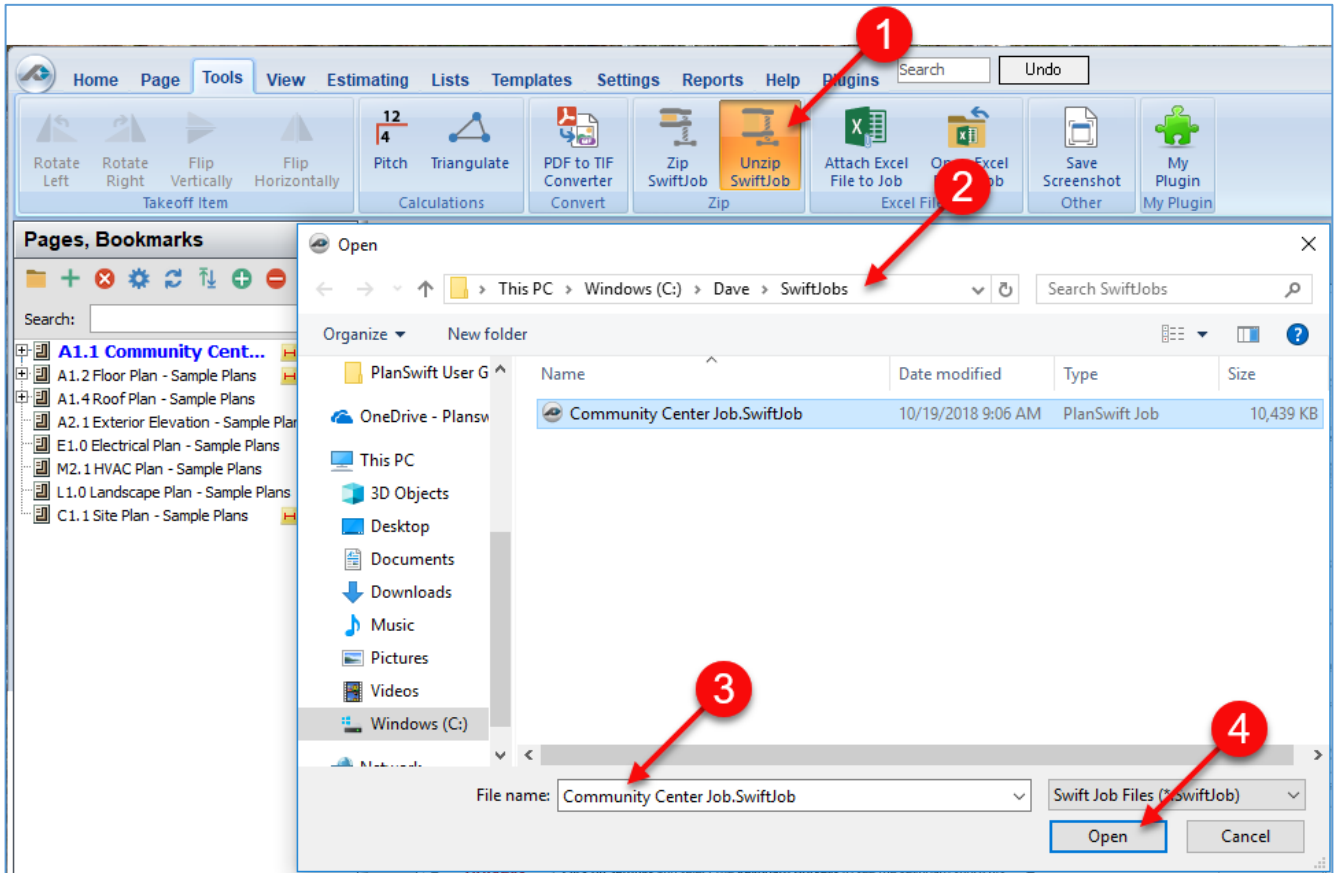

Figure 1-H

5. This opens the **Import Swift Job** window (Fig. 1-l).
6. Select the **Job Location** (**Local** or a network storage location).
7. Name the job.
8. Click on **Ok** to begin the importation.
9. If a job already exists in the same location with the same name, PlanSwift allows job overwriting.
10. The **Import Swift Job** window shows the status of the job as it loads.

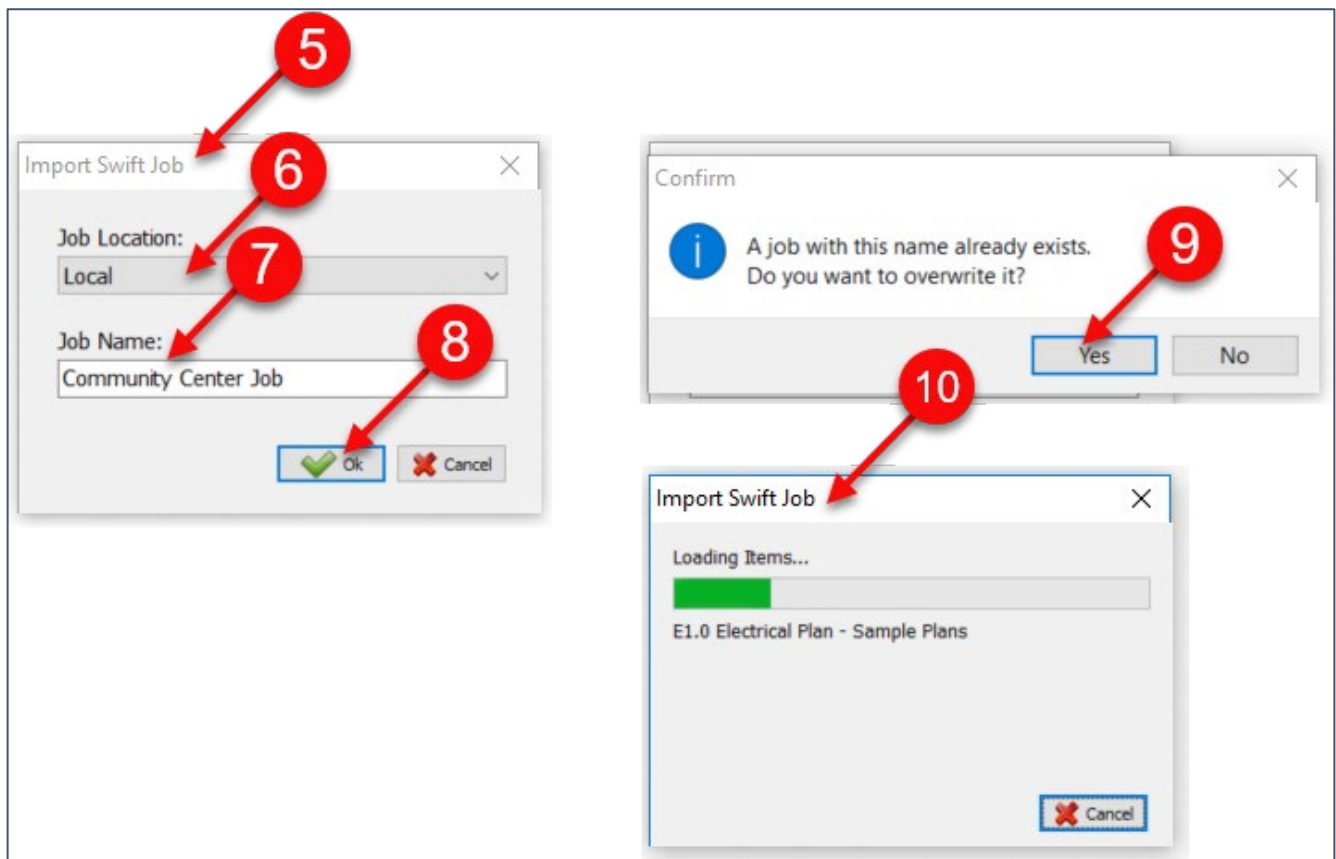

Figure 1-l

---

## Page Management

PlanSwift can import several types of image files, including PDF, TIFF, CAD, etc. Once imported into PlanSwift, we refer to these image files as pages.

### Setting the Scale

Accurate takeoffs require each page's scale to be set correctly. PlanSwift provides options for you to set the scale automatically or manually. When it is set automatically or manually, your scale will only be as accurate as the image file you imported.

**PlanSwift will not be held responsible for any loss associated with improperly scaled pages.**



## Setting the Scale Automatically

To set the scale automatically:

1. Click on the drop-down half of the **Scale** button (see Figure 2-A) to open a drop-down menu that allows for setting the scaling automatically.
2. If your page has a scale value or you already know the value, select that value from the drop-down menu. This will scale your page for both the X- and Y-axes.
3. Note that the **Standard** selection at the top of the drop-down menu is an alternate way of opening the [manual method](#) of scaling.
4. These markers indicate whether the scaling has been added to the page and the direction that it has been performed in (horizontally, vertically, or both).

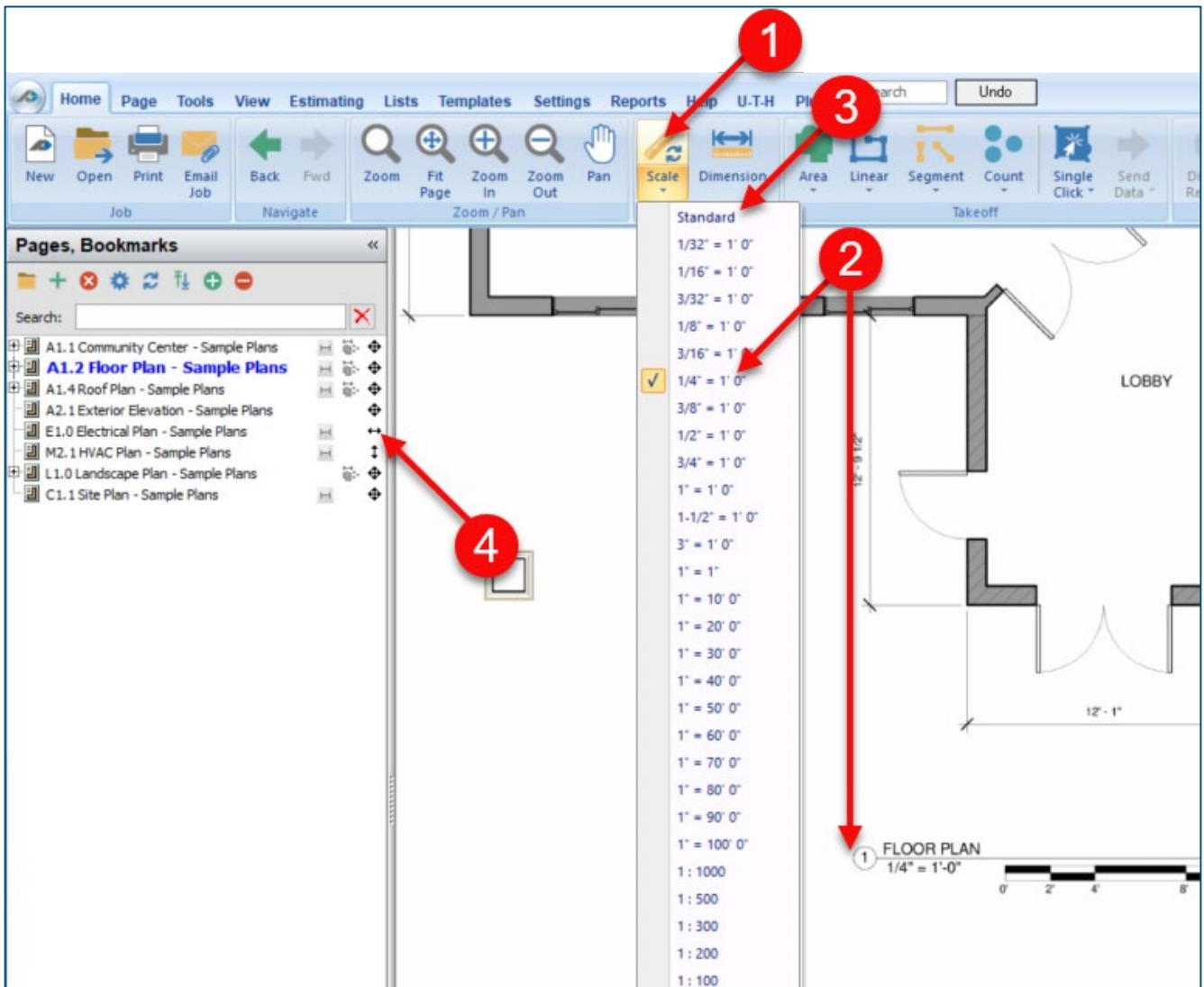

Figure 2-A

- Once the scale is set, it is highly recommended that you verify known dimensions—both horizontally and vertically—on each page to ensure the scale is set correctly. To verify the scale, the dimension tool is required. Click on the **Dimension** button, then, using the crosshairs for alignment, click on two **Points** of a marked *vertical* dimension (see Fig. 2-B), and a red dimension line and its measurement will appear.
- Then click another two **Points** of a marked *horizontal* dimension, and its dimension and measurement will also appear. Press **ESC** to terminate the Dimension tool. (The **Dimension** tool is covered under [Adding and Specifying Dimensions](#).)

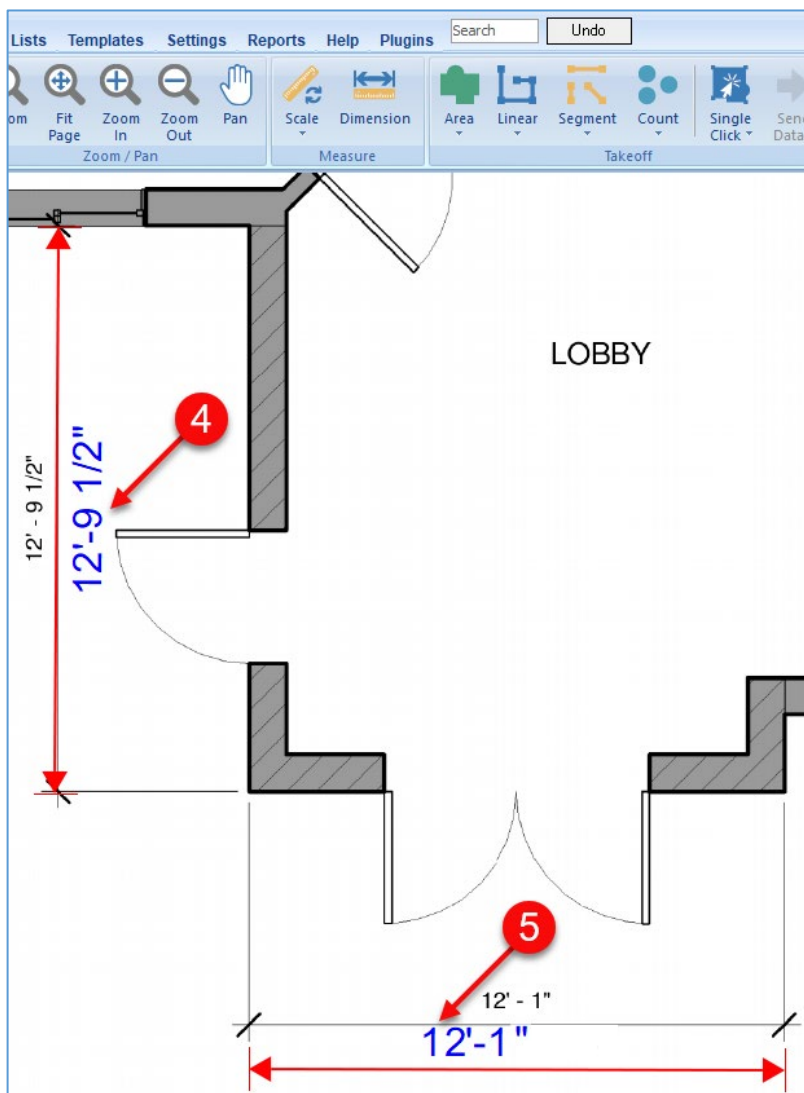

Figure 2-B

## Setting the Scale Manually

To set the scale manually:

1. Click on the top half of the **Scale** button (Figure 3-A).
2. This opens the **Scale** window.
3. The **Standard** tab allows you to enter a known dimension (feet, inches, and fractions of an inch).
4. Click the **Apply Scale to all pages** checkbox if you want the scale to be applied to all pages.
5. Click the **Automatically create dimension line** checkbox if you want a dimension line created.
6. Click on **OK** to move to the next step.
7. If you clicked on the **Apply Scale to all pages** checkbox, then a **Warning** box appears to warn that applying this scale to all pages may cause errors in measurements and calculations if all pages are not truly at the same scale. Pages must support DPI, or they cannot be auto-scaled. Acknowledge the warning by clicking **OK**.

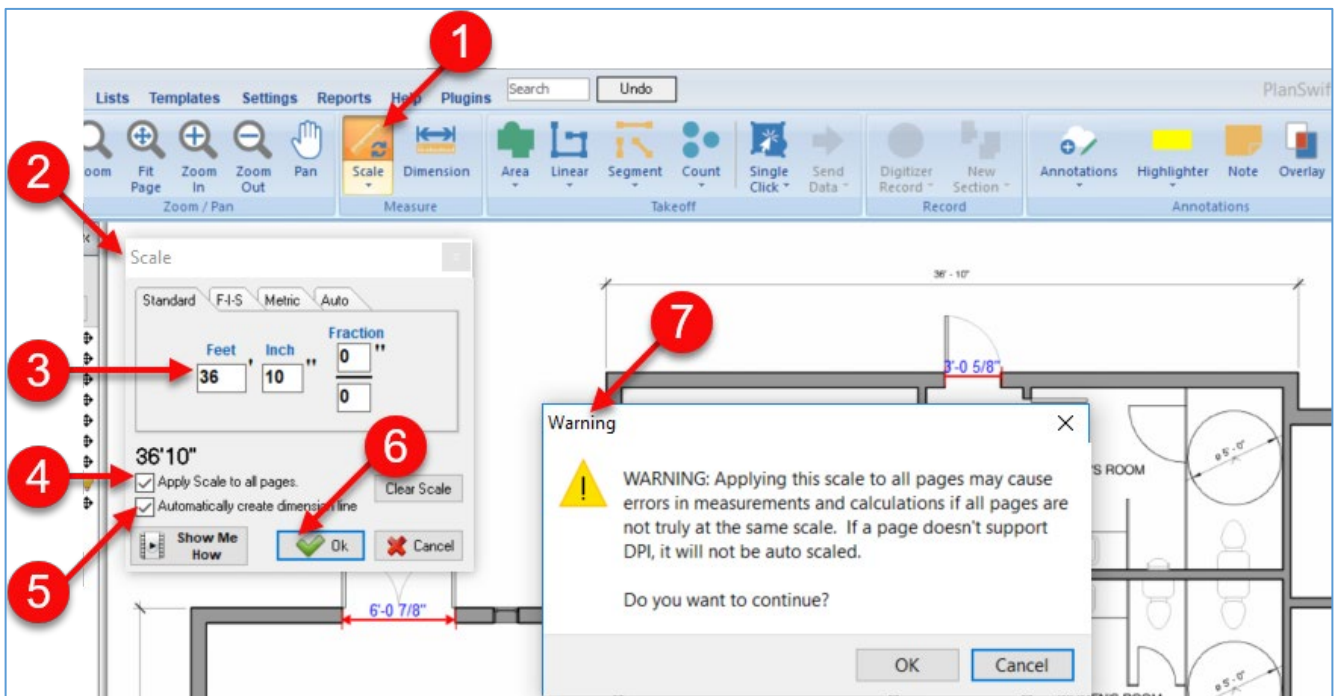

Figure 3-A

8. Click the first **Point** on the plan for the selected dimension. It may be helpful to press the **M** hotkey to magnify the image to place the **Point** more accurately (Fig. 3-B).
9. Click the second **Point** at the other end of the dimension.
10. After both **Points** are selected, and if you selected the **Automatically create dimension line** checkbox, then a green dimension line and the dimension measurement (in red) will appear. If you didn't check the **Automatically create dimension line** checkbox, then neither the dimension line nor the measurement is displayed.

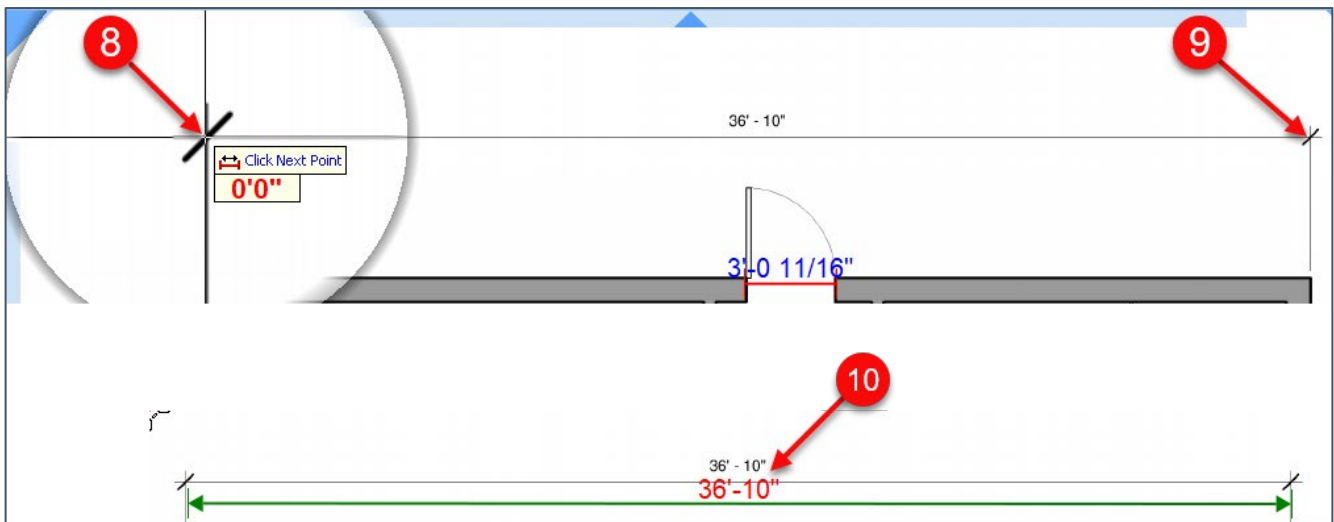

Figure 3-B

Note: it is recommended that you scale your page in both the X-axis and the Y-axis. The procedure is the same for the Y-axis as the X-axis, except that you will choose a dimension in the Y-axis to scale.

11. After a page has been scaled for both the X- and Y-axes, if you then attempt to rescale the page, the **Scale** window will display a **Clear Scale** option to allow the scale to be cleared (Figure 3-C). Clicking on **Clear Scale** and answering **Yes** to a confirmation (**Yes/No**) question clears the scale value for the current page. The **Scale** command can also be undone by clicking on the **Undo** command on the **Main** ribbon-bar menu immediately after the scaling operation.

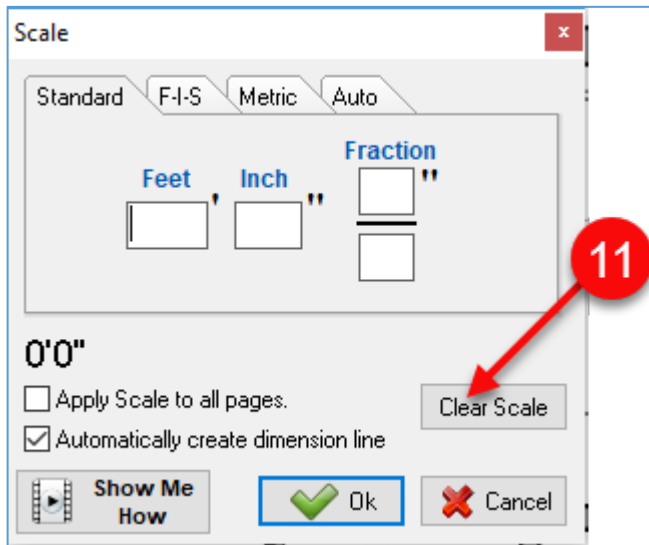

Figure 3-C

12. The **Auto** tab in the **Scale** window (Figure 3-D) allows you to scale the page in the same manner as you do when you click on the **Scale** drop-down menu. The **Auto** tab allows you to apply an automatic scale to *all* pages, whereas the **Scale** drop-down menu only does the current page.
13. The **F-I-S** tab in the **Scale** window is used by truss designers to input dimensions in Feet, Inches, and Sixteenths.
14. The **Metric** tab in the **Scale** window allows for scaling in metric.

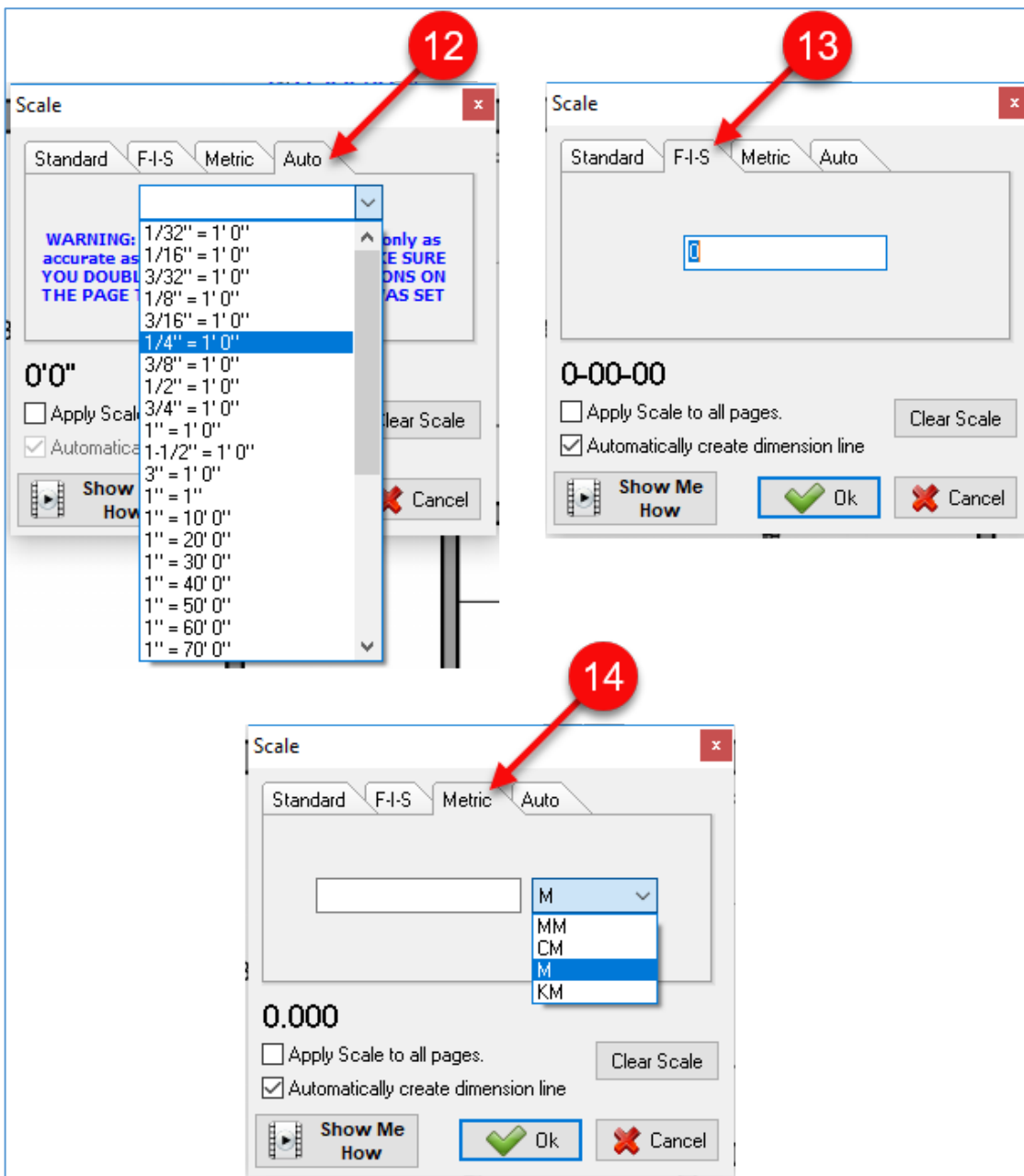

Figure 3-D

## Renaming Pages

PlanSwift allows you to rename pages individually or as a batch.

### Renaming Individual Pages

Individual pages may be renamed from the **Home**, **Page**, **Tools**, or **View** tabs on the **Main** ribbon-bar menu. To rename an individual page:

1. In the **Pages, Bookmarks** window, right-click the page to be renamed (Fig. 4-A).
2. Click on **Properties** on the drop-down menu.
3. This opens the **Properties** window for the selected page.
4. Enter the new name for the page in the **Name** field, then click on **Ok**. This renames the page and closes the **Properties** window.

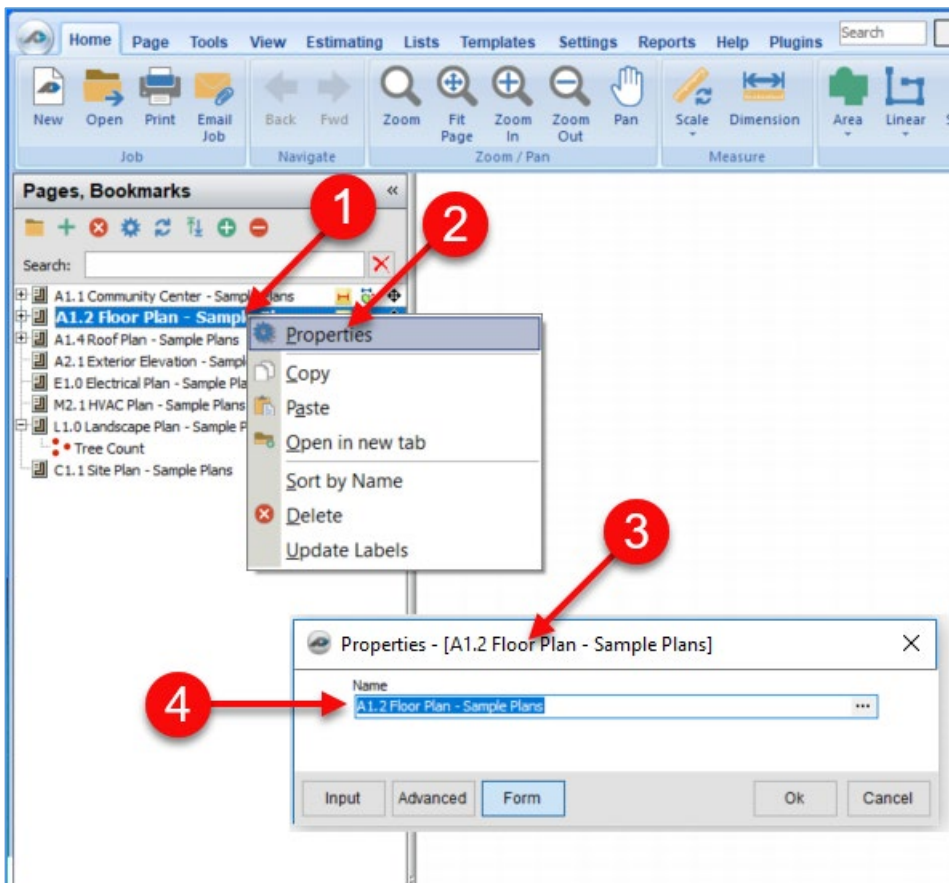

Figure 4-A

---

## Batch Renaming Multiple Pages

The **Batch Rename Pages** (Fig. 5-A) function makes renaming multiple pages easy. To rename several files:

1. Go to the **Pages, Bookmarks** window and click on the page you want to start the renaming process with.
2. Click on the **Batch Rename Pages** button in the **Rename/Sort** group on the **Page** tab of the **Main** ribbon-bar menu
3. This is the **Batch Rename Tool** window.
4. The current name of the page appears both in the **Current:** field and in the **New:** field.
5. The directional arrows allow you to select the corner of the page to be shown in the view.
6. Figure 5-A shows the bottom-right corner of the page selected.
7. Click on the **New:** field and type the new name.
8. Click on **Save & Next** to proceed to go to the next page.
9. If you want to view the previous page, click on **Save & Prev.** If there are any that you do not want to rename, click on **Save and Next** (or **Save & Prev.**) without providing a new name.



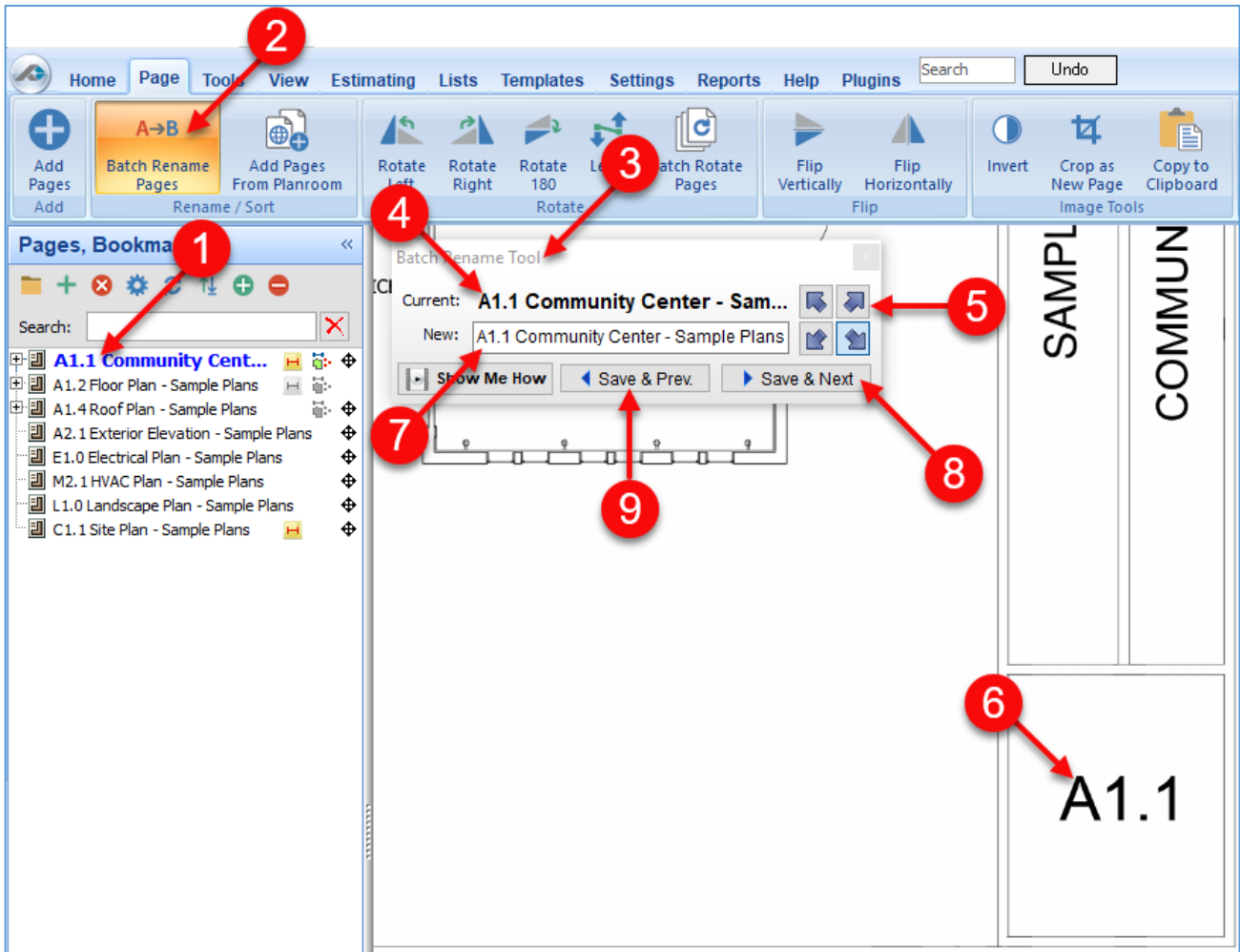

Figure 5-A

## Importing Additional Pages

Additional pages can be added to a job in either of two ways:

1. From the **Home** or **Page** tab, click on the green + in the **Pages, Bookmarks** window, or
2. From the **Page** tab, click on the **Add Pages** button (Fig. 6-A).
3. Either of these actions opens the **Add Pages** window.
4. If you want to select a new page from existing image files, click on **From Image Files** and click on **Next**. This opens the **Image Files** window (Fig. 6-B).

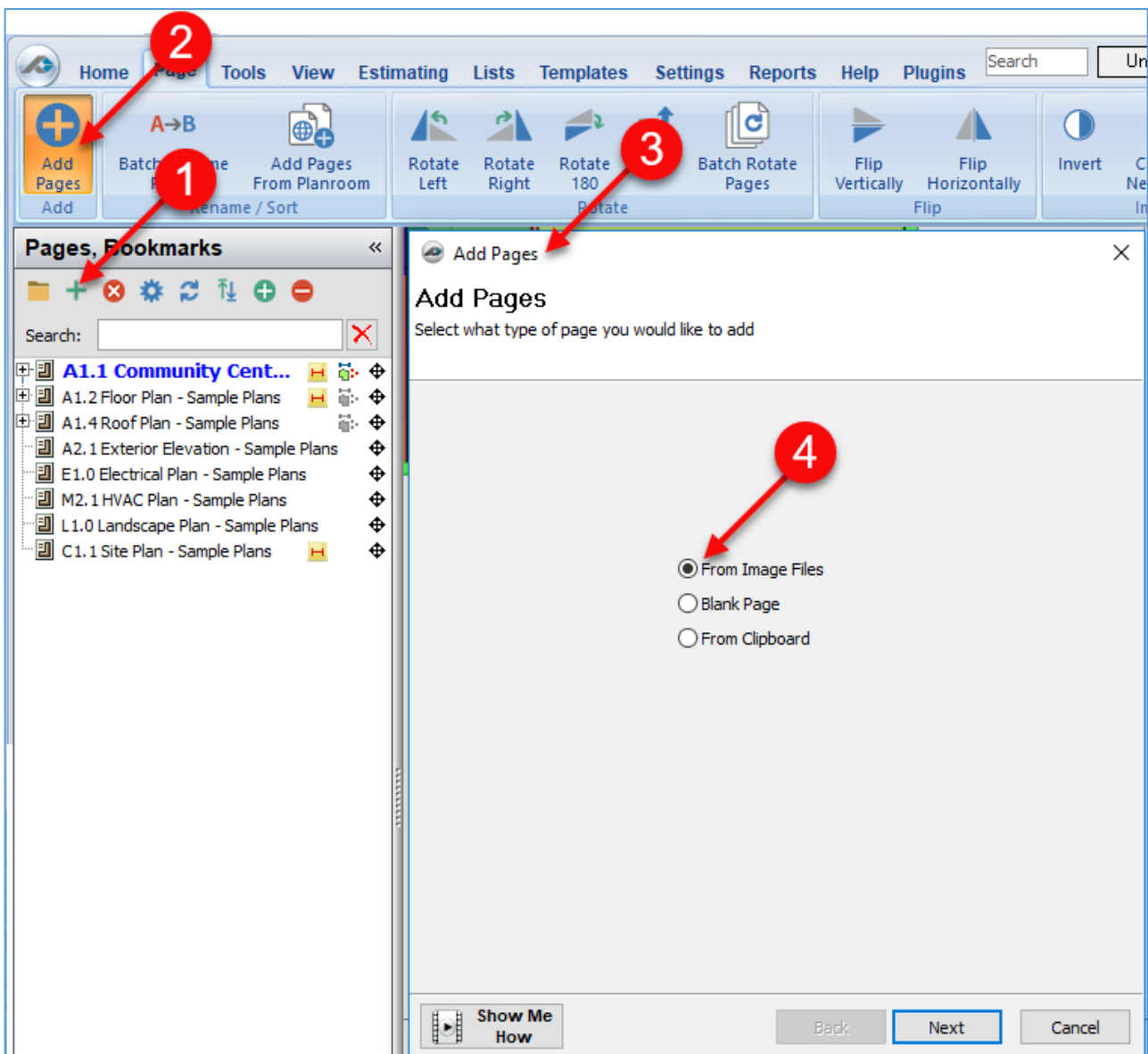

Figure 6-A

5. Click on **Browse** to locate the folder with the image files in the **Browse for Folder** (Fig. 6-B).
6. Click on **OK** after you click on the location.
7. Click on the checkbox (or boxes) for the image file (or files) that you want to add to this job.
8. Click on **Next**.

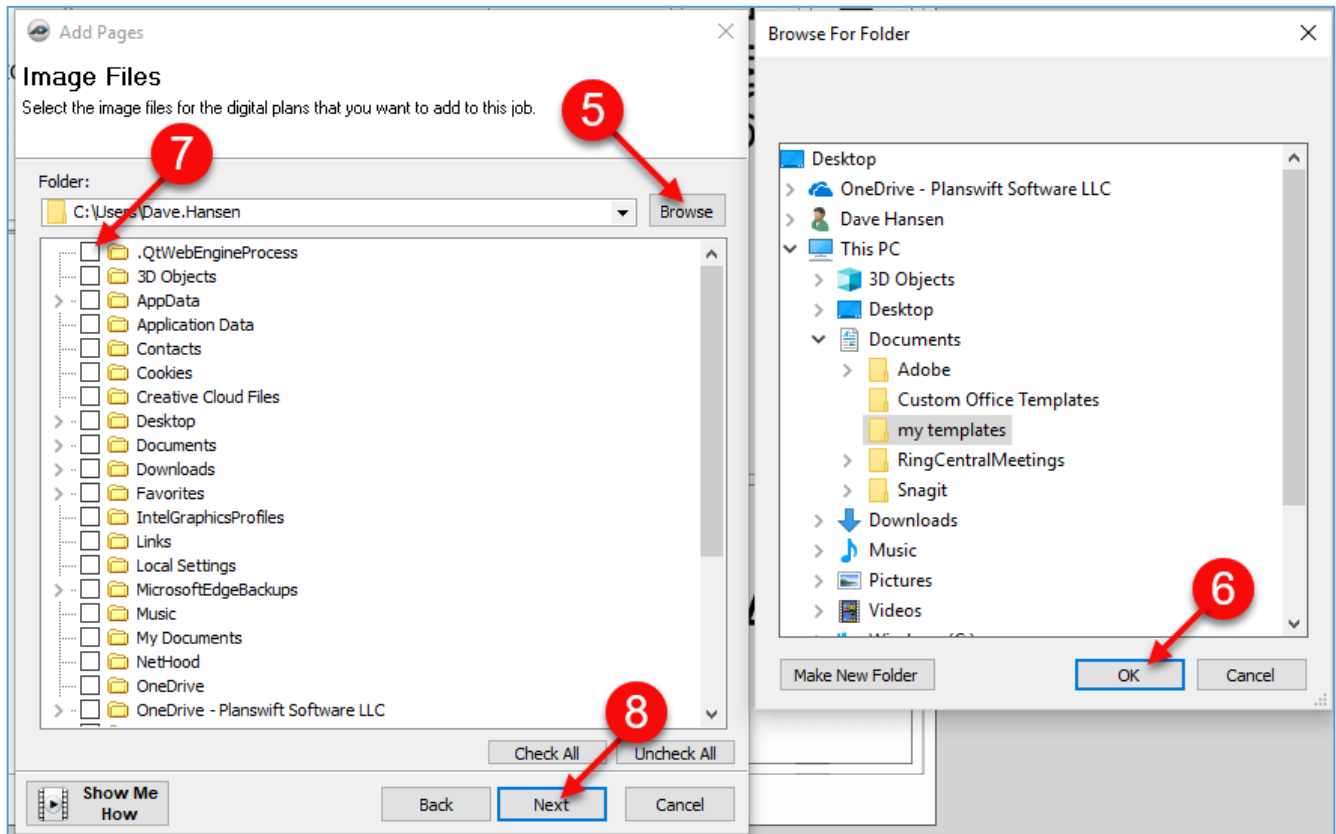

Figure 6-B

9. This opens the **Convert Settings** window (Fig. 6-C). Make any changes in this window.
10. Click on **Next**.
11. This opens the **Ready to Add Files** window.
12. Click on **Finish** to add the file.

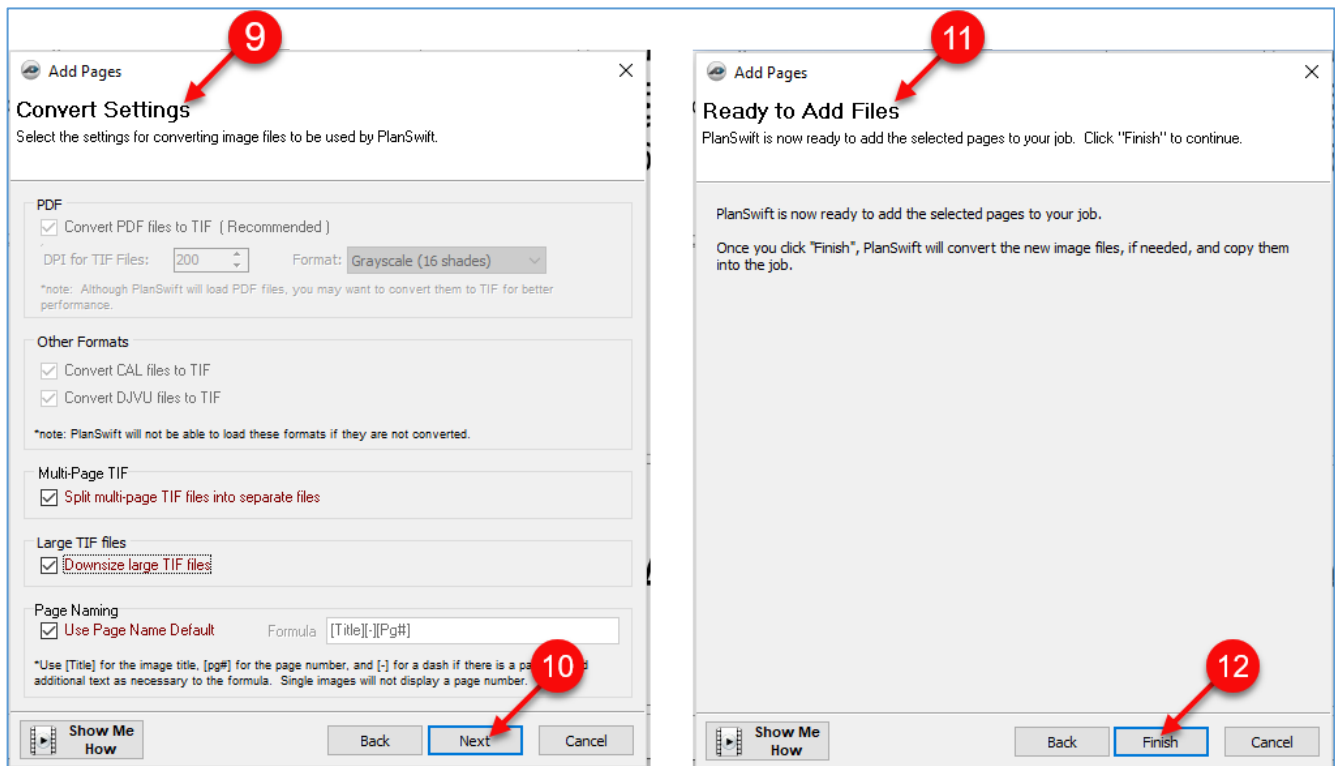

Figure 6-C

13. If you want to add a blank page, click on **Blank Page** from the **Add Pages** window (Fig. 6-D).
14. Click on **Next**.
15. This opens the **New Blank Page** window.
16. Enter the **Name, Width, Height, DPS, and Scale**.
17. Click on **Finish** to add the blank page.
18. If you want to use an image stored on your clipboard, click on **From Clipboard**, then click on **Finish**. Whatever is stored on your clipboard will be placed on the new page. If nothing is stored in your clipboard, then **From Clipboard** will not be selectable.

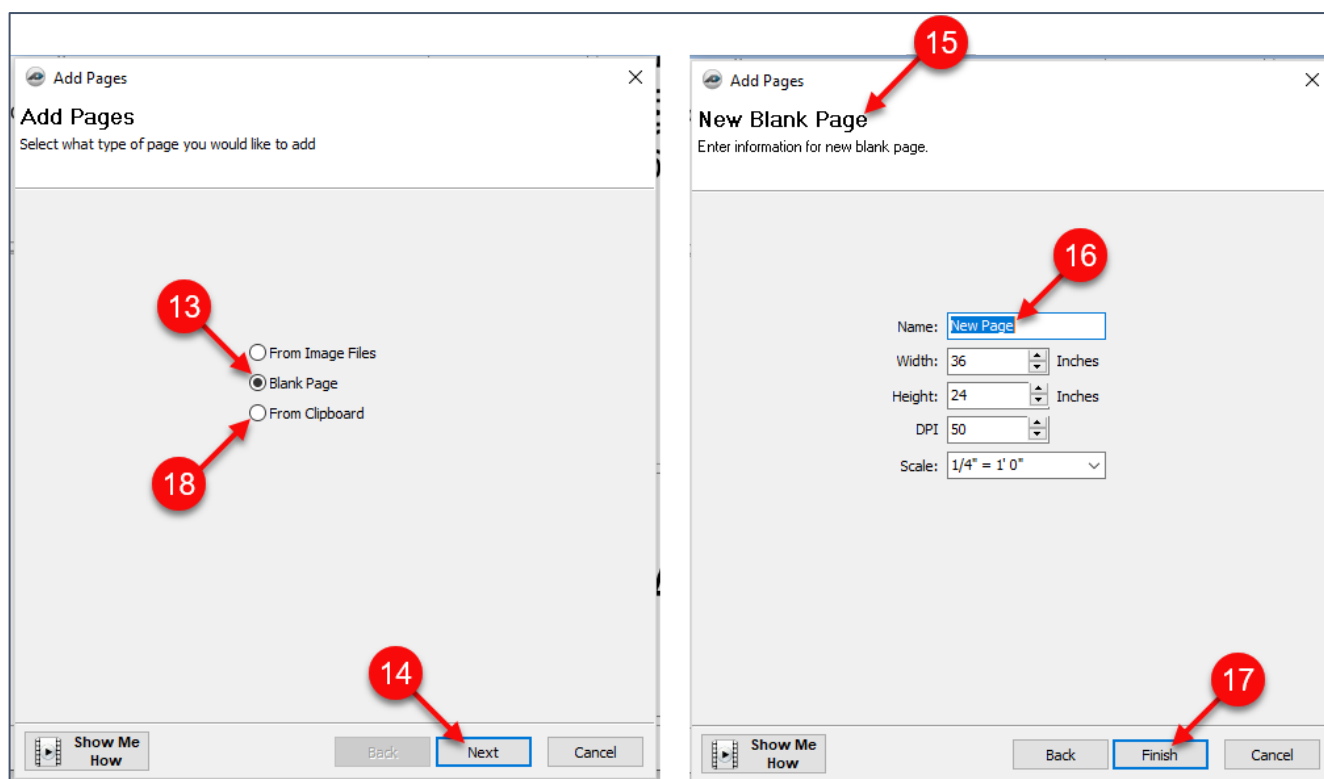

Figure 6-D

## Creating Folders for Pages

To create a new folder for pages:

1. Click on the yellow folder button in the **Pages, Bookmarks** window (Fig. 7-A).
2. In the **New Page Folder** window, enter the name for the folder and click on **OK**.

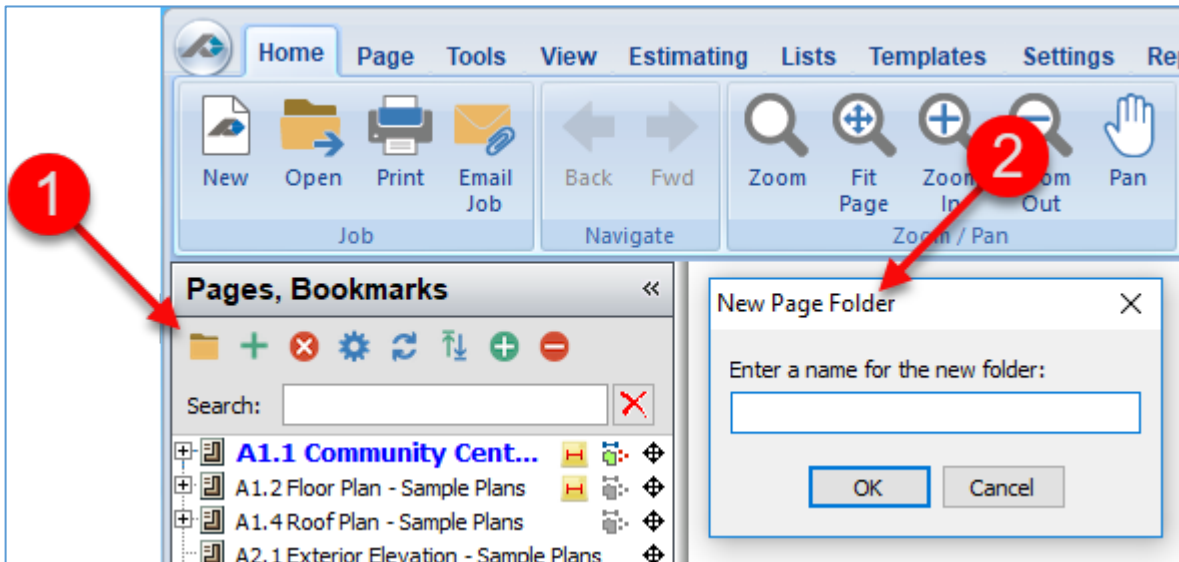

Figure 7-A

## Adjusting the Page or Folder Order

To move a page or folder within a job:

1. In the **Pages, Bookmarks** window, click on the page or folder to be moved and drag the page (or folder) up or down to the location it is to go (Fig. 8-A).
2. If you want the page (or folder) to be placed inside a folder, **click and drag** it until the folder you want it placed in is highlighted by a blue box, then release the cursor.
3. If you want the page to be placed in-between either folders or other pages, **click and drag** it until you see a blue line in between the items where you want it, then release the cursor.

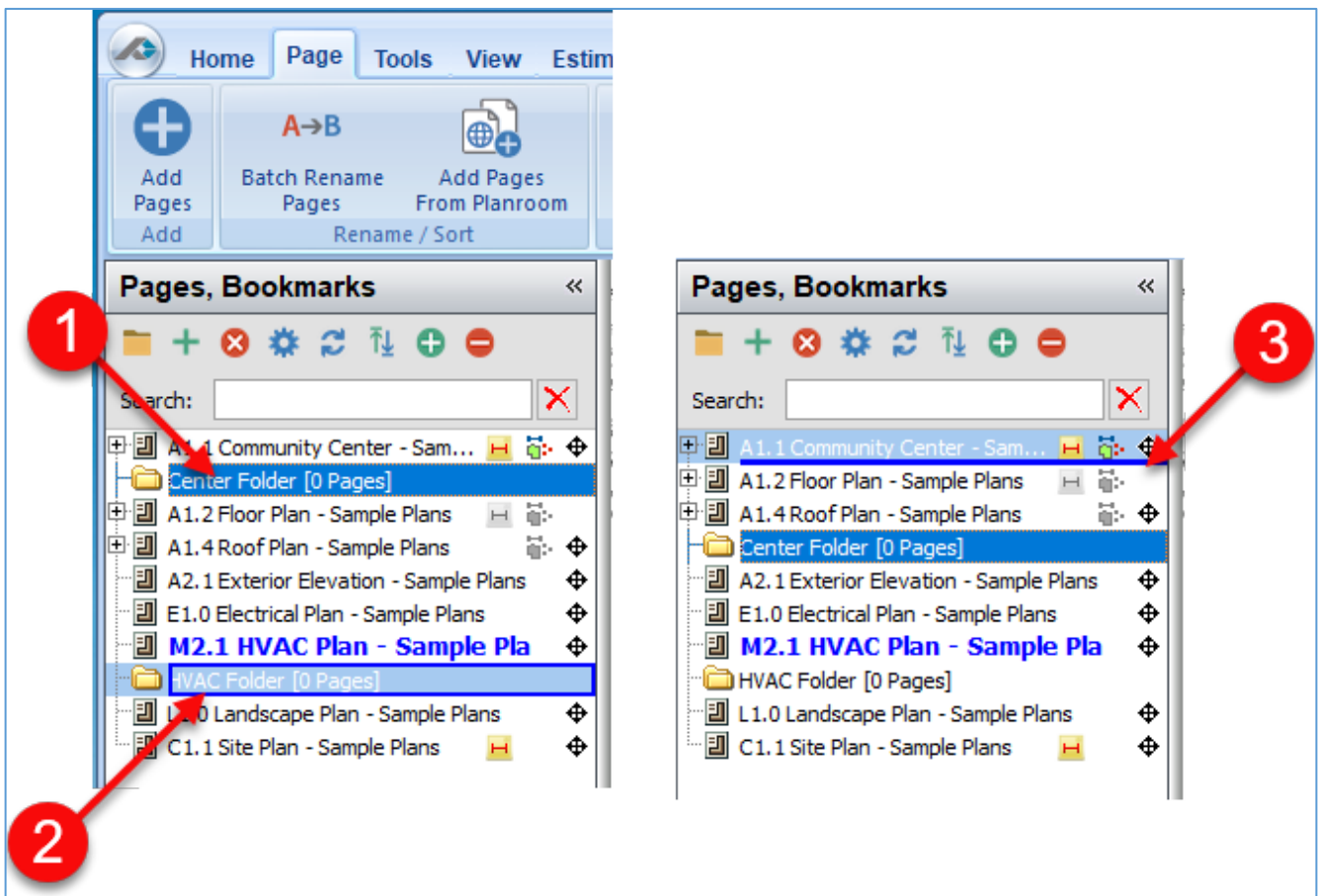

Figure 8-A

4. An alternate way of adjusting the page order is to click on the page reorder button to open the **Adjust Pages Order** window (Fig. 8-B).
5. Click on the folder and use the **four small arrow** buttons to move folders up or down and left or right in the hierarchy.
6. The **large up and down arrow** buttons move a selected file to the top or bottom of the list.

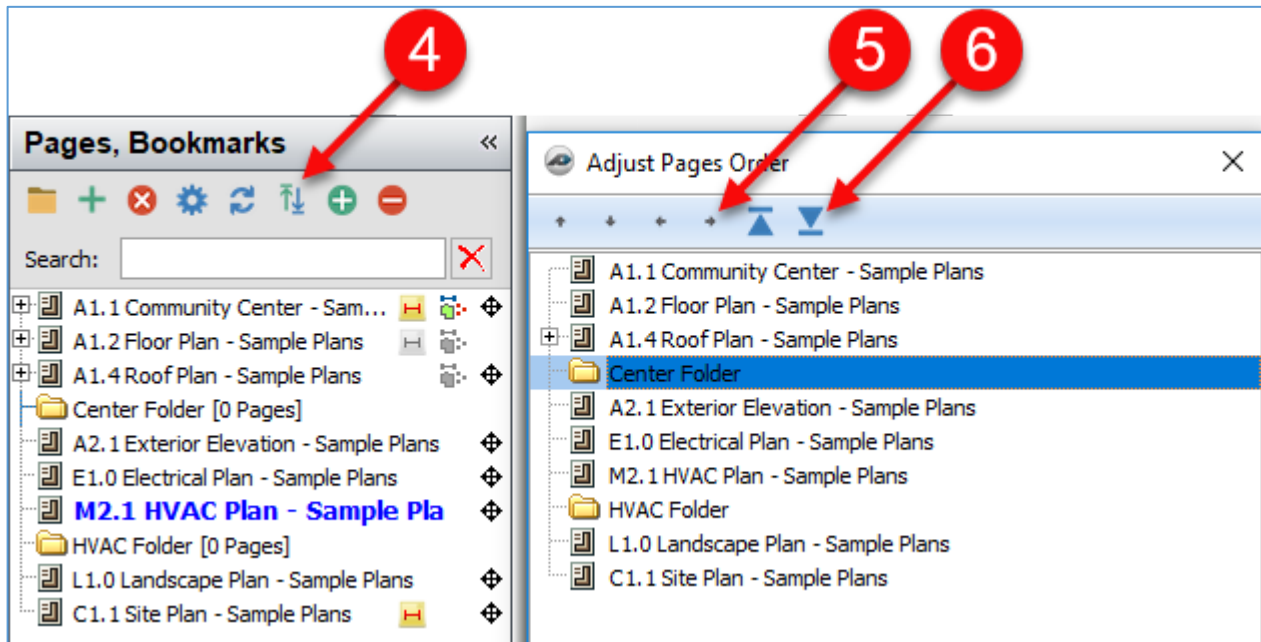

Figure 8-B



## Managing Page Tabs

PlanSwift permits you to open multiple pages, each on a different tab, close the tabbed pages, and undock tabbed pages so that different pages may be displayed on multiple monitors.

### Opening and Closing Tabbed Pages

To open a page in a new tab:

1. Right-click on any page (in this case the A1.1 Community Center page) in the **Pages, Bookmarks** window to open a right-click menu (Fig. 9-A).
2. Click on **Open in new tab** option.

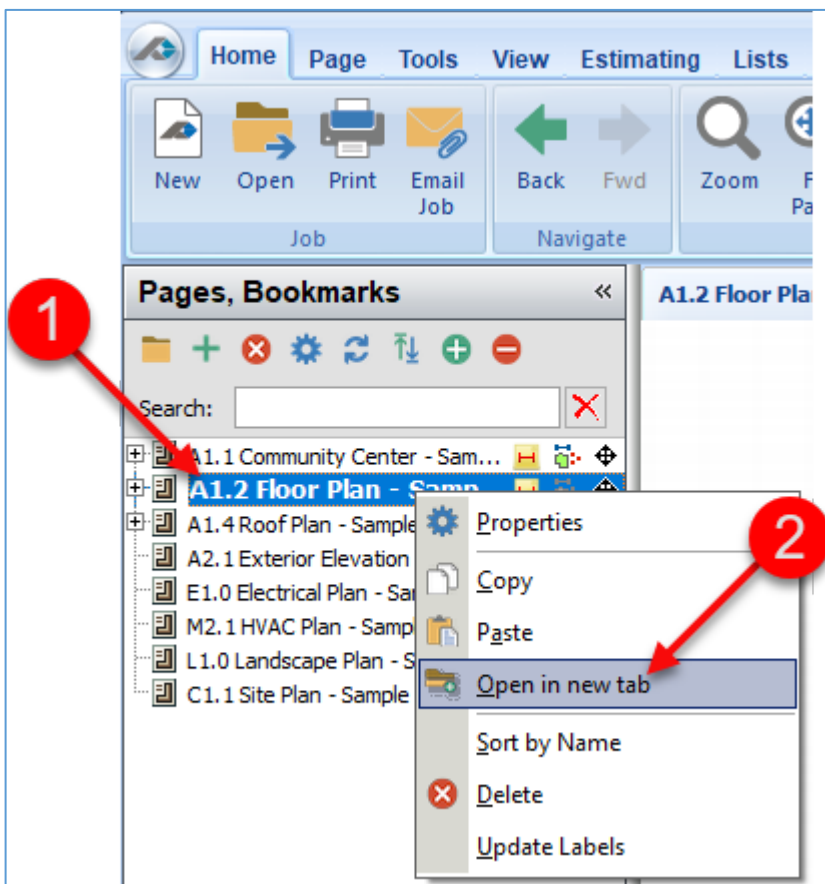

Figure 9-A

3. The A1.1 Community Center now appears on two separate tabs (Fig. 9-B). Clicking on either one of the tabs makes the clicked-on tab's page active. Clicking on a different page in the **Pages, Bookmarks** window opens the selected page in the active tab. Takeoffs may be performed on any active tabbed page.
4. To close a tab, right-click on the tab to be closed and click on **Close**. Note that clicking on **New Tab** on this right-click menu also creates a new tab but with a blank page.

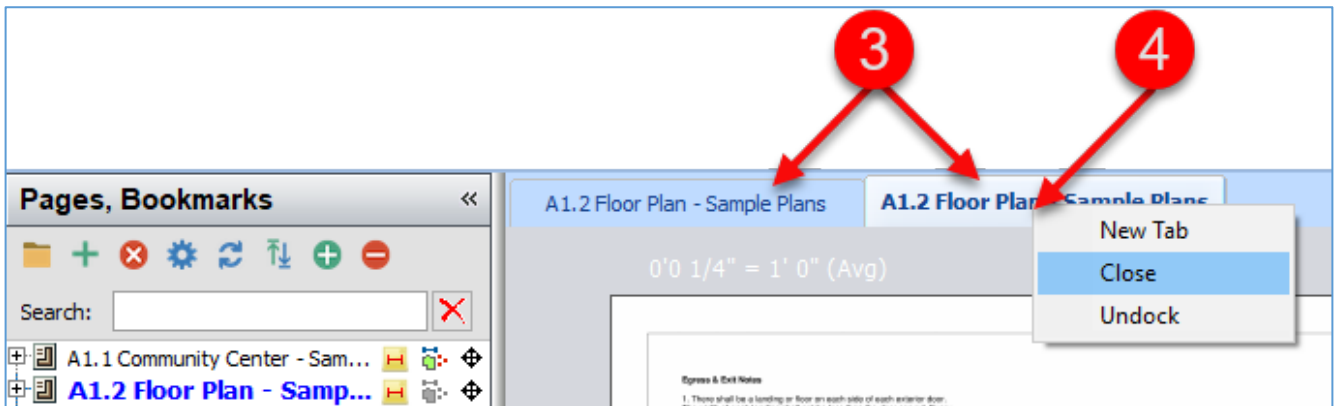

Figure 9-B

## Undocking a Tabbed Page

To undock a tabbed page:

1. Right-click on the **tabbed page** you want to **Undock** to open the drop-down menu (Fig. 9-C).
2. Click on **Undock**.

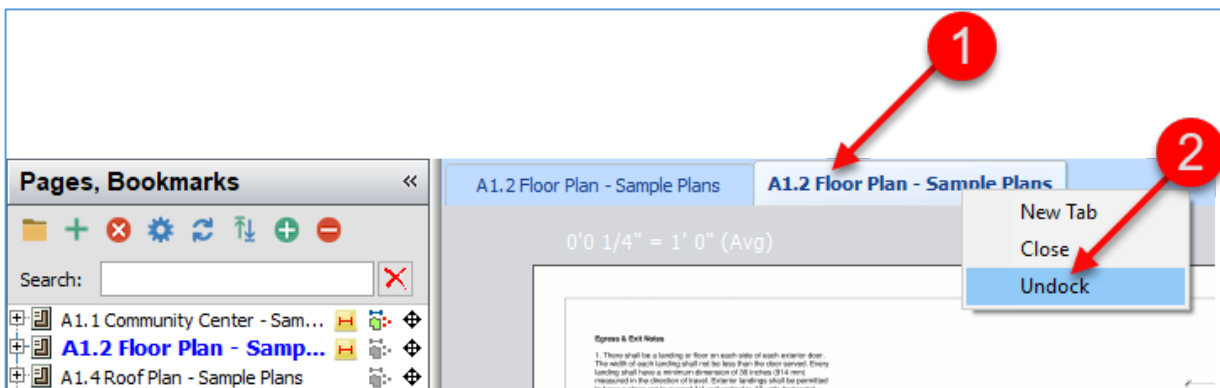

Figure 9-C

- The **undocked page** appears in a new window (Fig. 9-D). Clicking and dragging on the title bar of the **undocked page** allows you to drag it to another monitor or wherever else you want it.

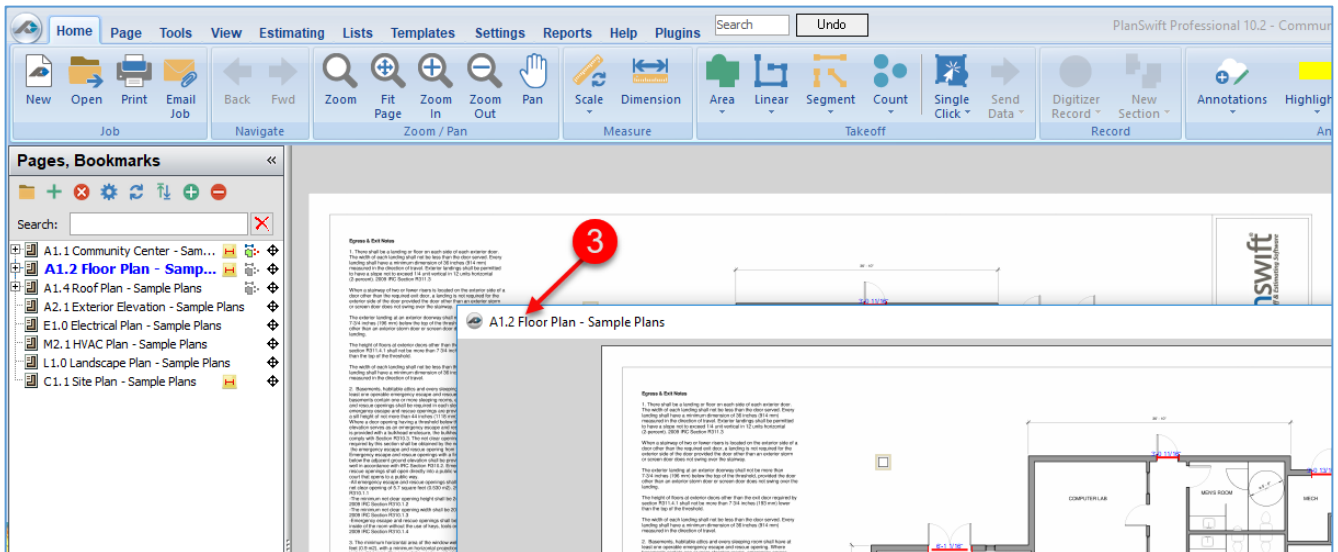

Figure 9-D

To re-dock an **undocked page** back to a **tabbed page**:

- Right-click on an **undocked page** to open a drop-down menu (Fig. 9-E).
- Click on **Close** to dock the page back to a **tabbed page**.

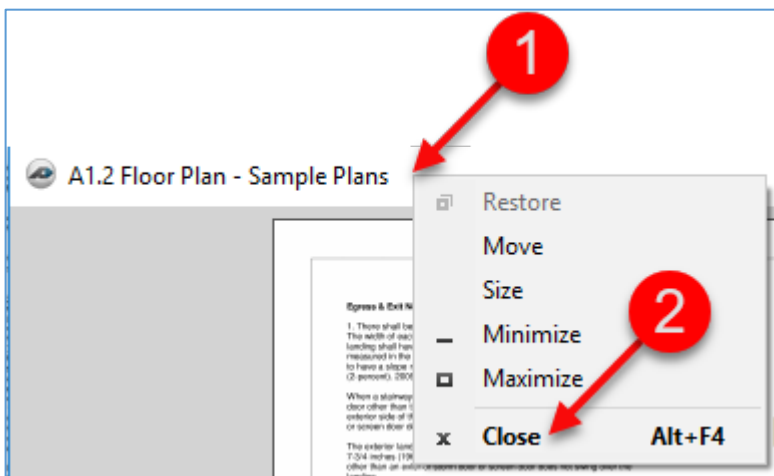

Figure 9-E

---

## Performing Basic Takeoffs

Performing—or digitizing—a takeoff inside of PlanSwift Professional is easy. PlanSwift has four basic measuring (or takeoff) tools, which are identified as takeoff items or types: **Area**, **Linear**, **Segment**, and **Count** (PlanSwift also has specialty takeoff items detailed in [Accessing Specialty Takeoff Items](#)).

## Creating New Takeoff Items

Newly created takeoff items can be used for performing your takeoffs on the fly; takeoff items can also be modified and saved as templates for future use in digitizing your takeoffs. Creating templates is covered in [Creating and Organizing Templates](#).

## Area Takeoff

Area takeoffs are useful for calculating areas for concrete, carpet, flooring, roofing, pavement, sod, grids, joists, etc. The top half of the **Area** button performs an area takeoff. The drop-down half is a drop-down menu that provides area takeoffs with more powerful functions, such as creating an area takeoff with a [single click](#), calculating [area costs by the square foot](#), and performing area takeoffs for [roofs](#), [cubic yards](#), [grids](#), and [joists](#). Area takeoffs may also include [arcs](#), multiple measurements (or sections), and [cutouts](#) (or subtracted sections). To perform an area takeoff:

1. Click on the top half of the **Area** takeoff button (Fig. 10-A), or simply press **1** on the keyboard.
2. In the **Properties – [Area]** window, enter a name for the area in the **Name** field.
3. Select a **Color** for the takeoff.
4. Select a **Fill Type**. It can be **Solid**, **Hatch Pattern**, or **Texture**; then click on **Ok**.
5. **Digitizer Record** is now turned on.

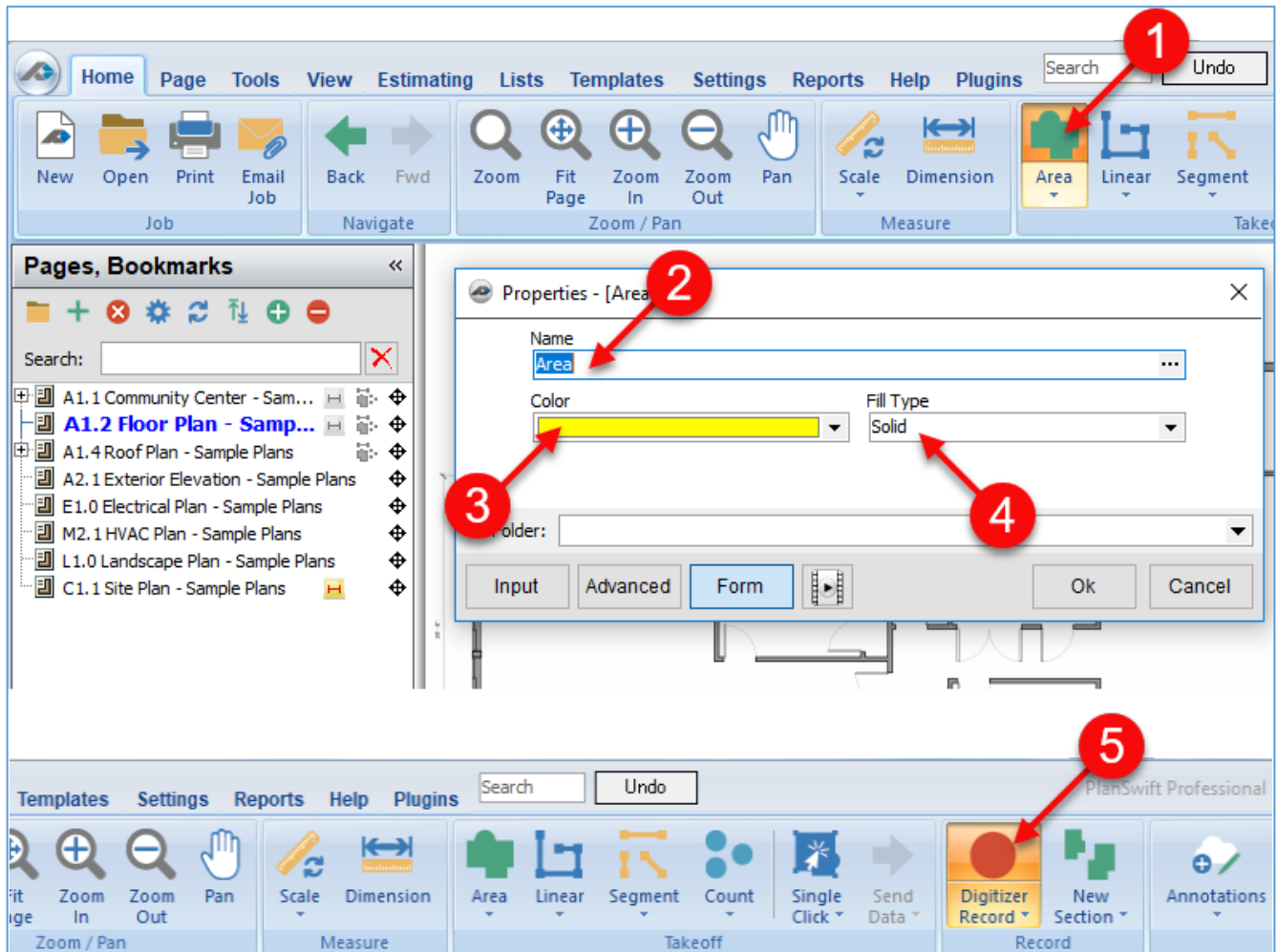

Figure 10-A

6. Click where you want the **Area** takeoff to begin. This will establish the first **Point**, which is the starting **Point** of the takeoff item (Fig. 10-B).
7. Move to the next **Point** and click again. Note that a blue line appears while in **Digitizer Record** mode. Note also that pressing **Ctrl + Z** will undo any **Point's** placement.
8. Move to the third **Point** and click. You now see the color of the takeoff that you selected.
9. Move to the fourth **Point** and click.
10. Right-click at the fourth **Point** and select **Stop** from the right-click menu (or press the **Esc** key or click on the **Digitizer Record** button or press **C** on the keyboard) to turn off record and complete the takeoff.

The right-click menu gives you another option, which is **New Section**. Selecting **New Section** also stops the takeoff you just completed, and it then allows you to move to a new section and continue the takeoff just as if you are at Step 6 again. This “new section” takeoff is a continuation of the first takeoff.

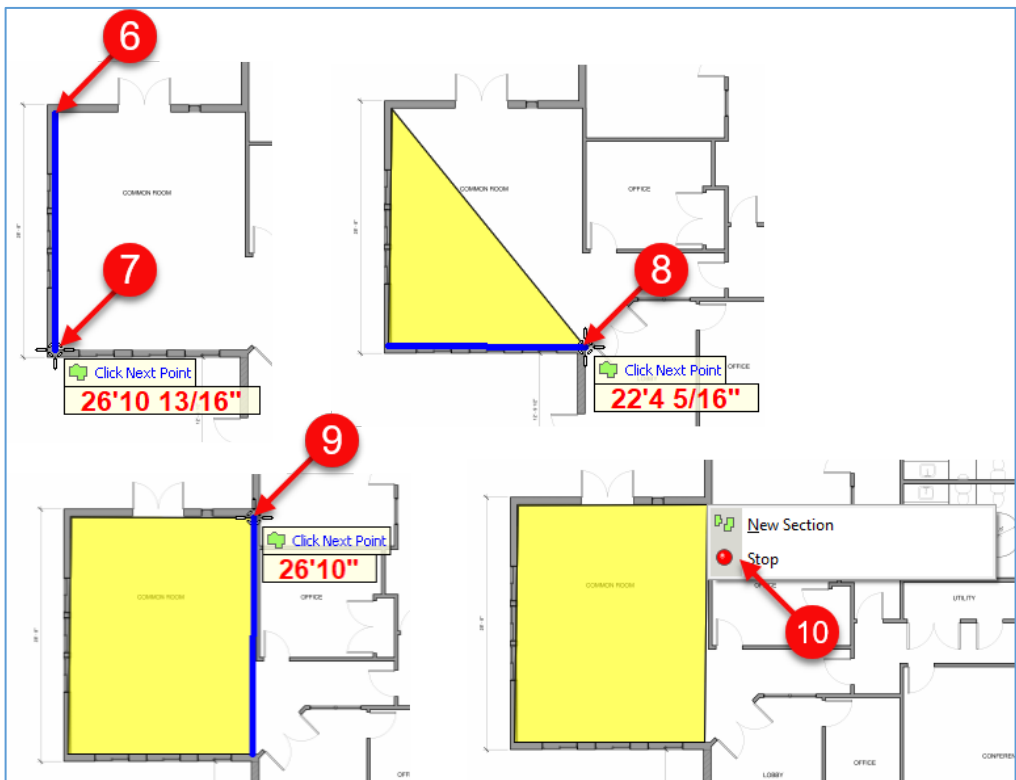

Figure 10-B

11. Figure 10-C shows two **area sections** (12 and 13) totaling 832.9 SQ FT.

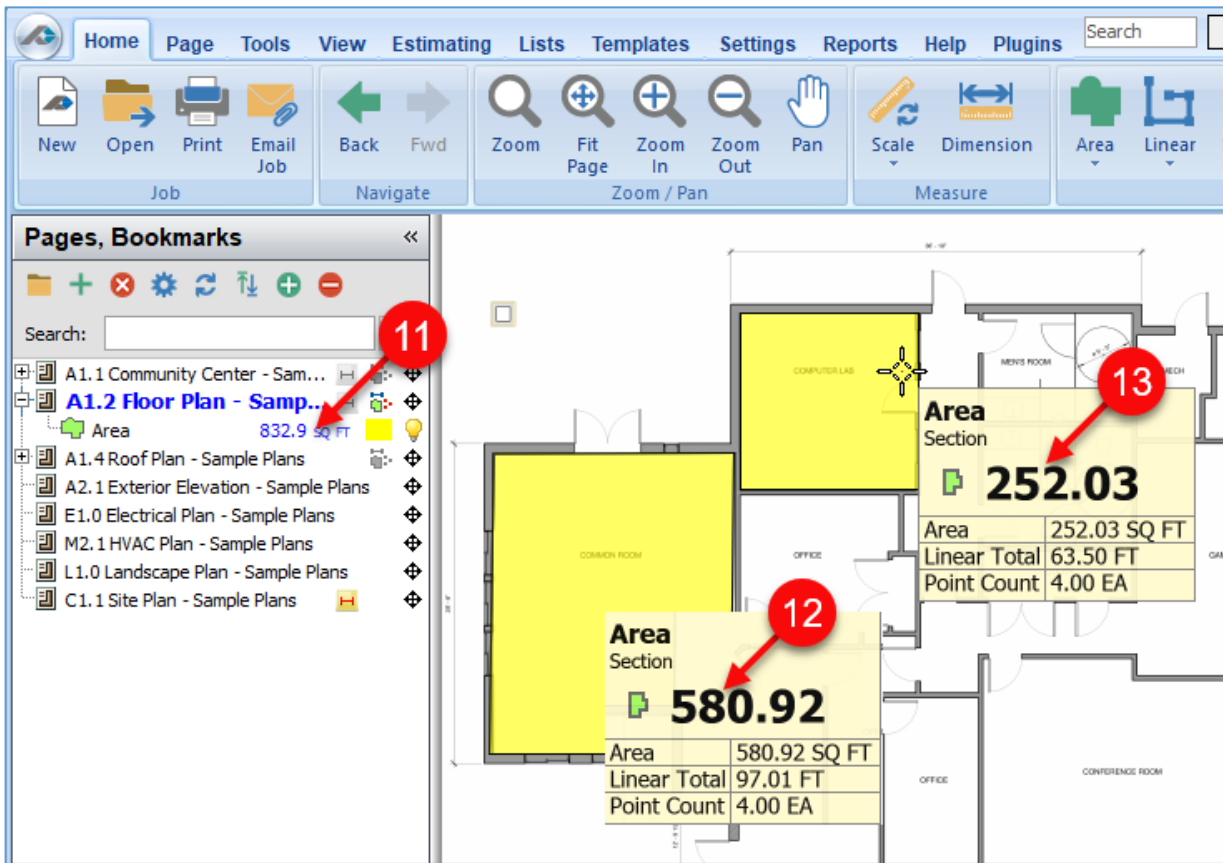

Figure 10-C

Note: There are two modes for performing area takeoffs. The default record mode is **Record: Point-to-Point**. The alternate mode is **Record: Box-Mode**, which allows you to simply click and drag a box (or click two **Points** to form a box) when the digitizer is turned on. This mode can only be changed when the **Digitizer Record** is on and is toggled between the two modes by clicking the **Record Mode** button located at the bottom of the main window (Fig. 10-D).

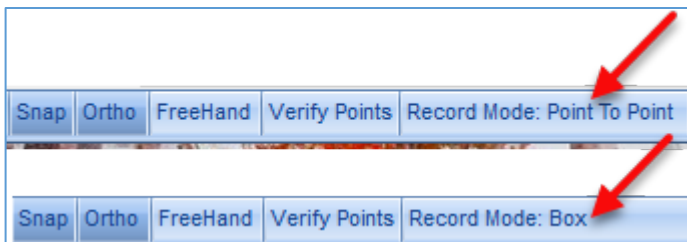

Figure 10-D

## Linear Takeoff

Performing a **Linear** takeoff is like performing an area takeoff. Linear takeoffs are useful for calculating materials such as gypsum board, studs, fencing, siding, masonry, piping, HVAC ducting, electrical runs, linear cubic yards, etc. Linear takeoffs may include arcs and multiple measurements (or sections). To perform a linear takeoff:

1. Click on the top half of the **Linear** button on the **Home** tab menu or press **2** on the keyboard (Fig. 11-A).
2. This opens the **Properties – [Linear]** window.
3. Give the linear takeoff a **name**.
4. Select a **color** for the takeoff.
5. Click on **Ok** to begin the takeoff.
6. Move the cursor crosshairs to the first **Point** of the takeoff.

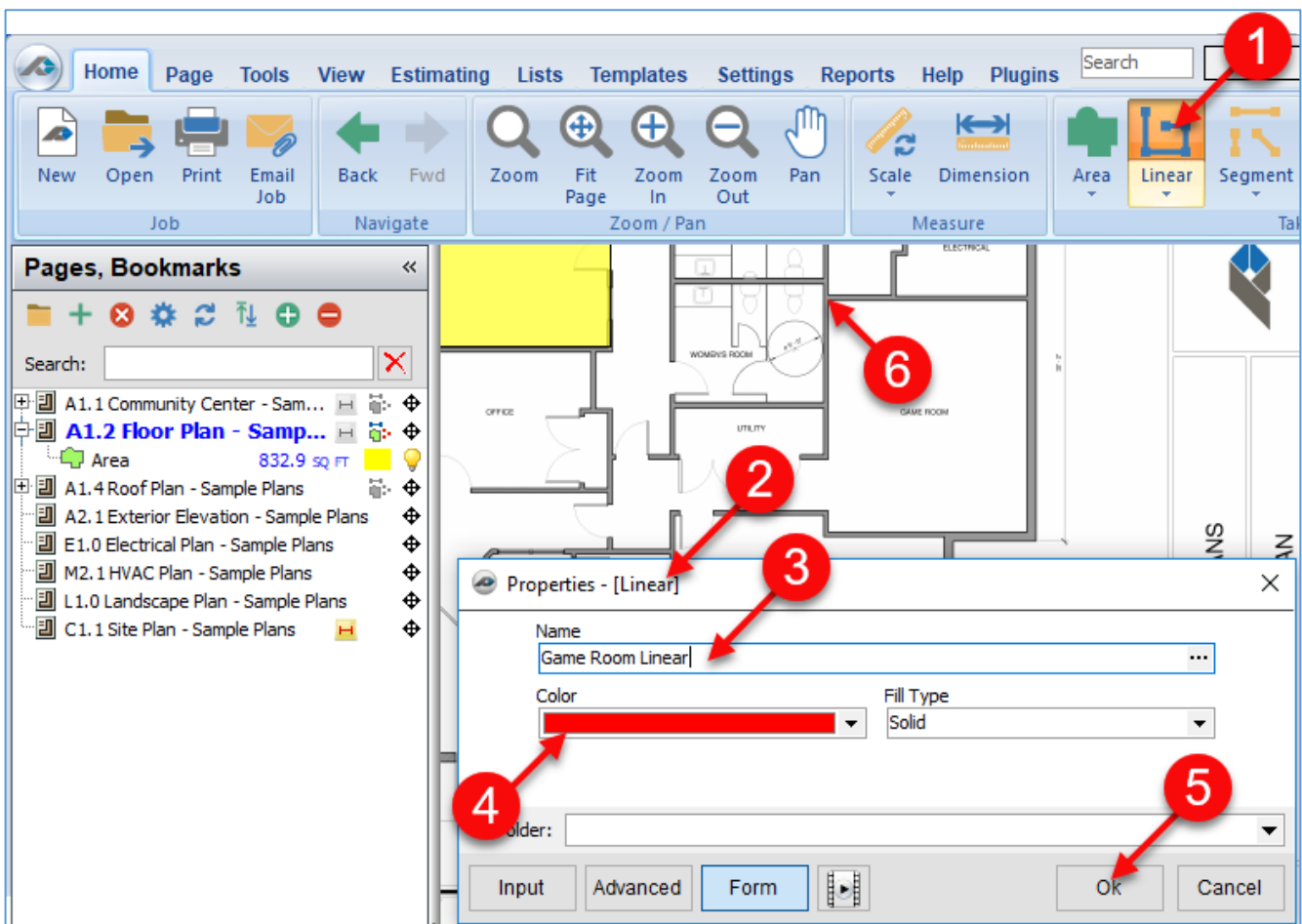

Figure 11-A



7. Press the **M** key on the keyboard to magnify the **Point** for greater accuracy and click on the location where you want to begin the takeoff (Fig. 11-B).
8. Click on the second **Point**, using the magnifier as needed.
9. Click on the third **Point** to perform the linear takeoff. Note that pressing **Ctrl + Z** will undo any **Point's** placement.
10. Click on the fourth **Point**.

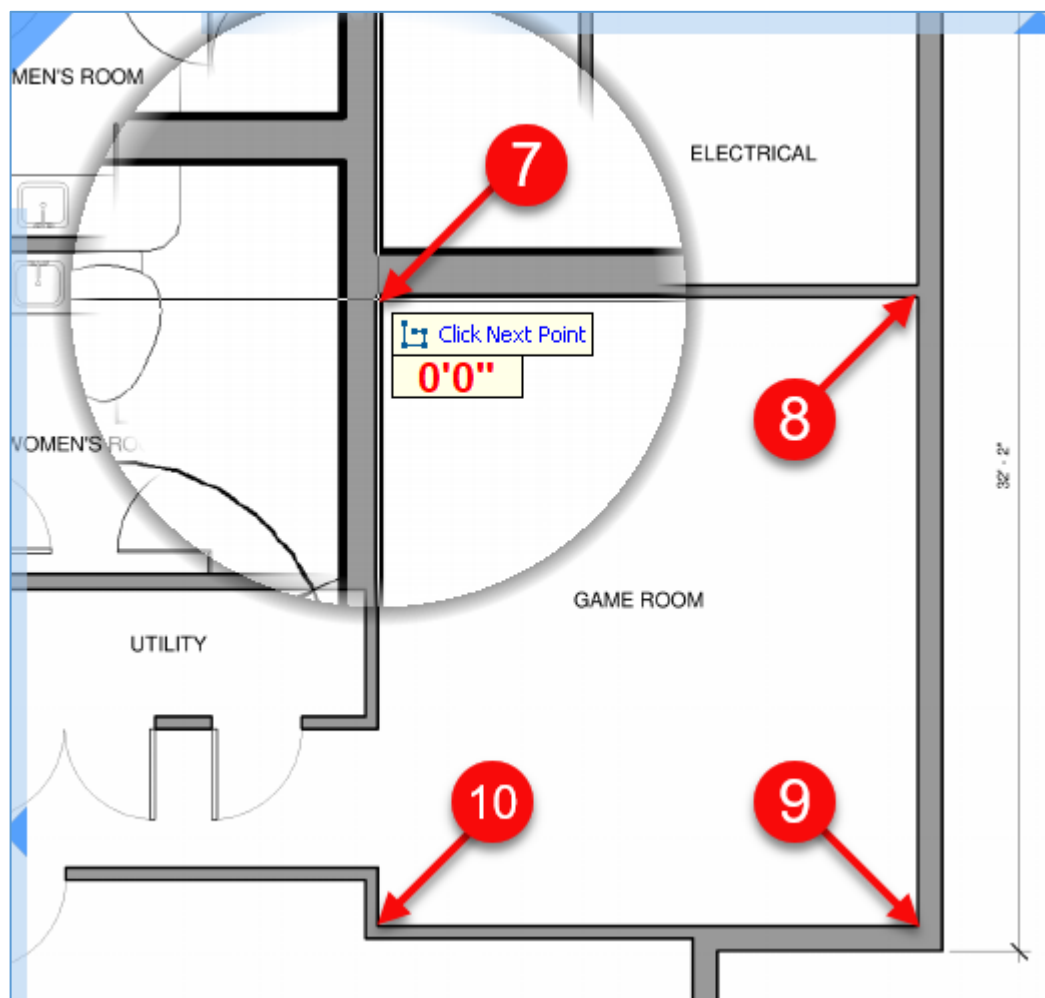

Figure 11-B

11. Click back at the beginning **Point**, then right click and click on **Stop** on the drop-down menu or press **C** or **Esc** on the keyboard to close the linear (Fig. 11-C).
12. The red line depicts the linear takeoff and is 77.1 feet in length.

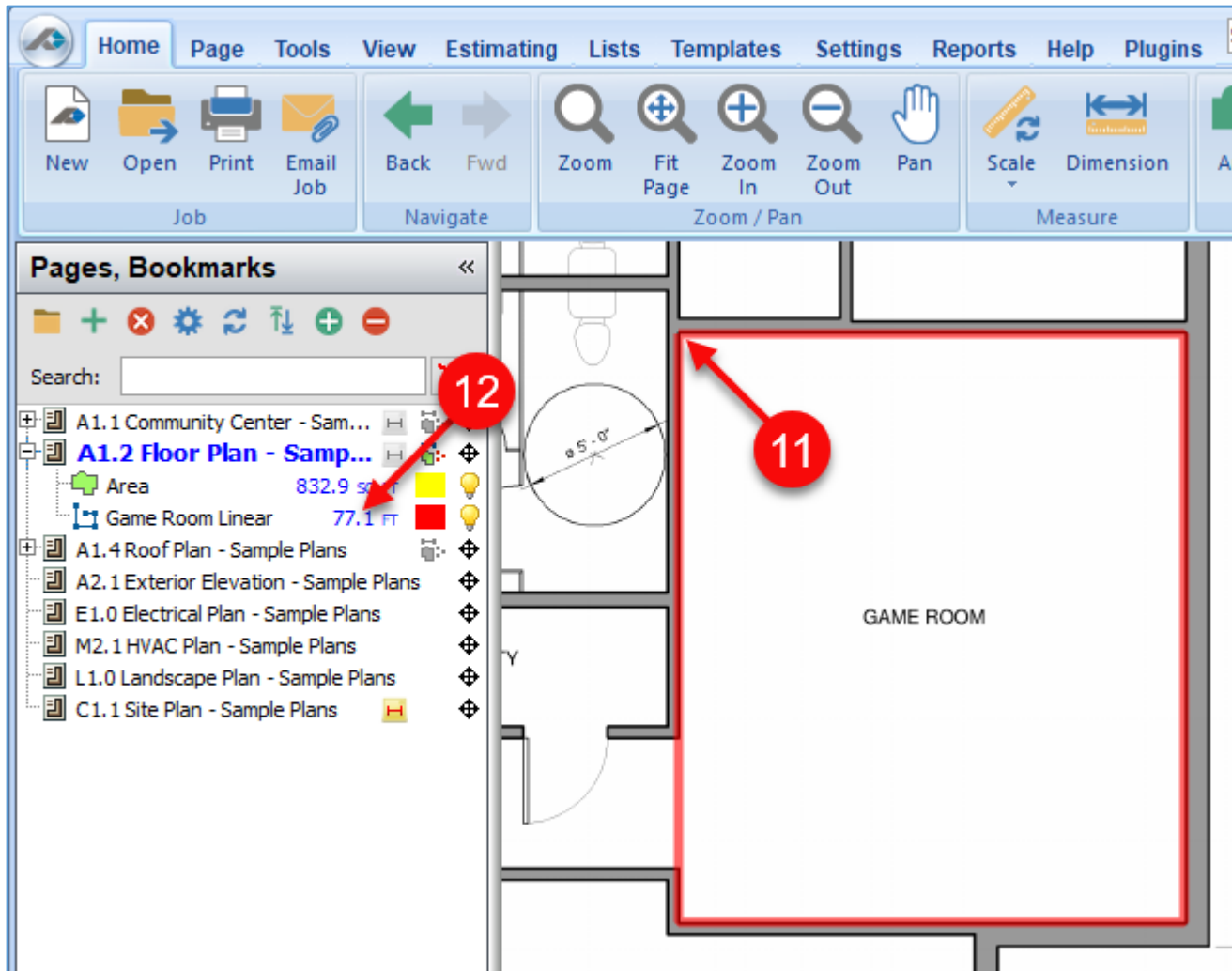

Figure 11-C

Note: There are two modes for performing linear takeoffs. The default record mode is **Record: Point-to-Point**. The alternate mode is **Record: Box-Mode**, which allows you to simply click and drag a box (or click two **Points** to form a box) when the digitizer is turned on. This mode can only be changed when the **Digitizer Record** is on and is toggled between the two modes by clicking the **Record Mode** button located at the bottom of the main window (Fig. 11-D).

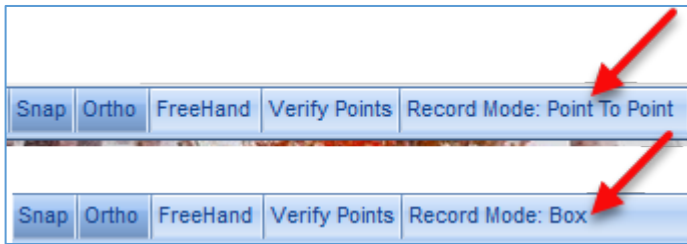

Figure 11-D

## Segment Takeoff

Performing a **Segment** takeoff is like performing a linear takeoff. Segment takeoffs are used for calculating any segmented items, such as beams, joists, segment cubic yards, wall areas, hip-valley, etc. Segment takeoffs are performed with one or more single-line measurements (or sections) and may include arcs. To perform a segment takeoff:

1. Click on the top half of the **Segment** button on the **Home** tab menu or press **3** on the keyboard (Fig. 12-A).
2. This opens the **Properties – [New Segment]** window.
3. Give the segment takeoff a **name**.
4. Select a **color** for the takeoff.
5. Click on **Ok** to begin the takeoff.
6. Move the cursor crosshairs to the **area** of the takeoff.

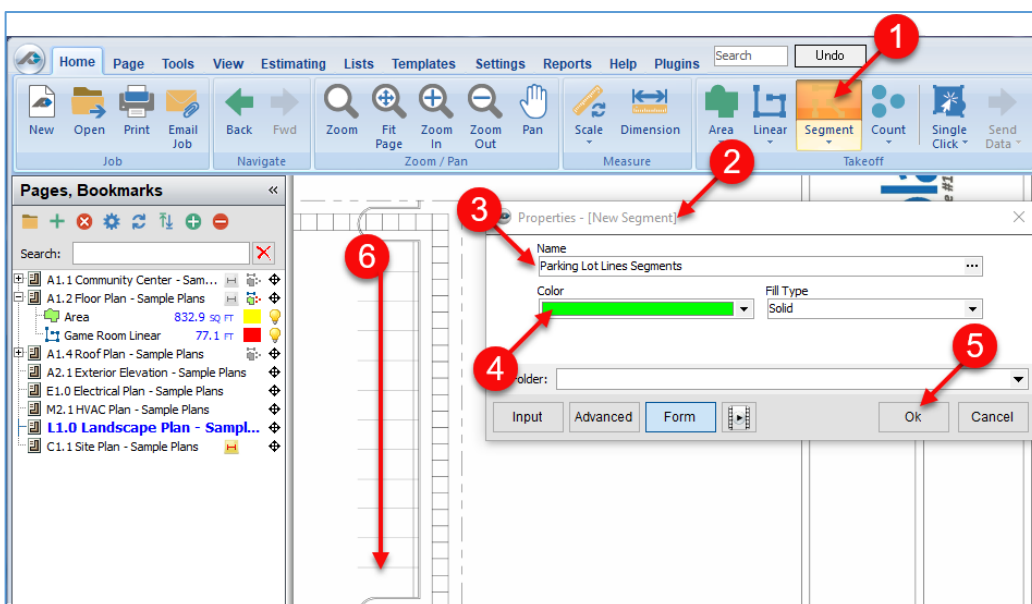

Figure 12-A

7. Click on the beginning and end of each parking lot line, treating each as an individual segment. Press **M** on the keyboard if you wish to magnify the area for more accuracy (Fig. 12-B). Note that pressing **Ctrl + Z** will undo any **Point's** placement.
8. The completed **segments** are shown to the right.

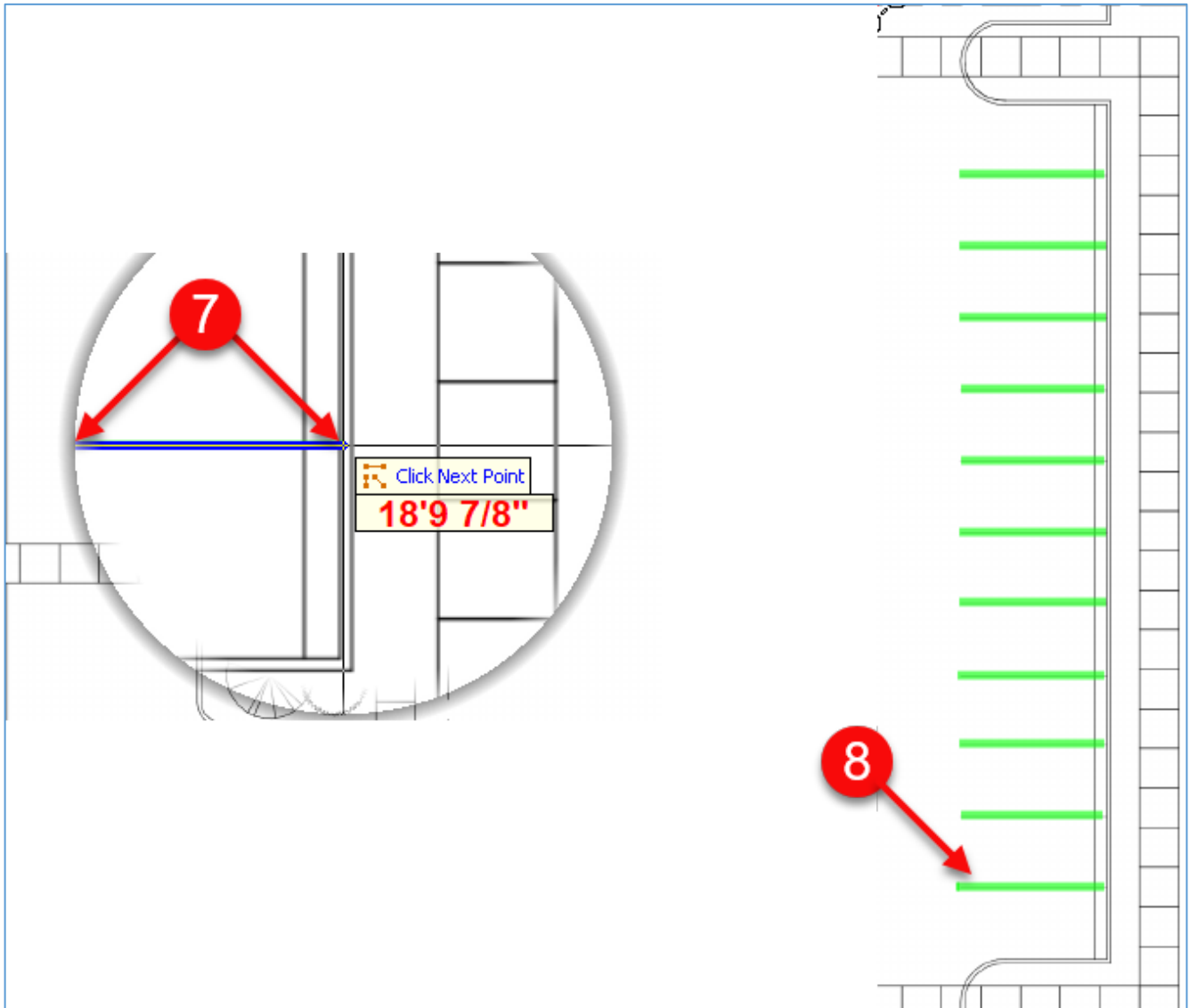

Figure 12-B

## Count Takeoff

Performing a **Count** takeoff requires familiarity with performing an area takeoff. Count takeoffs are useful for counting items such as electrical sockets, lighting fixtures, fans, doors, vents, trees, etc. To perform a count takeoff:

1. Click on the top half of the **Count** button on the **Home** tab menu or press **4** on the keyboard (Fig. 13-A).
2. This opens the **Properties – [New Count]** window.
3. Give the count takeoff a name.
4. Select a **color** for the takeoff.
5. Select a **shape** for the count item. Shapes to choose from are **Circle**, **Square**, **Triangle**, **Plus**, or **Diamond**. Keep **Circle** as the choice.
6. Click on **Ok** to begin the takeoff.
7. Move the cursor crosshairs to the first item to be counted for the takeoff and click on the item. Here you will do a tree count takeoff.

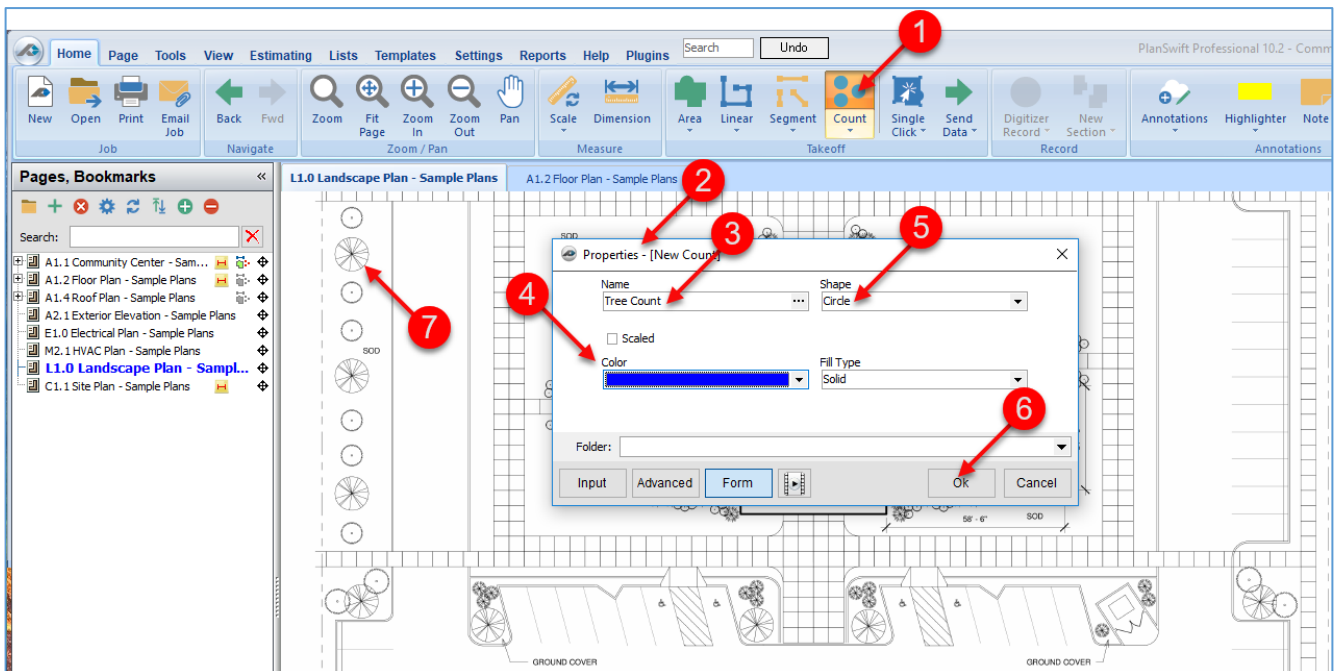

Figure 13-A

- Click on the remaining tree items and press **Esc** to stop the takeoff (Fig. 13-B). Note that pressing **Ctrl + Z** will undo any **Point's** placement.
- The tree count takeoff value is 20.

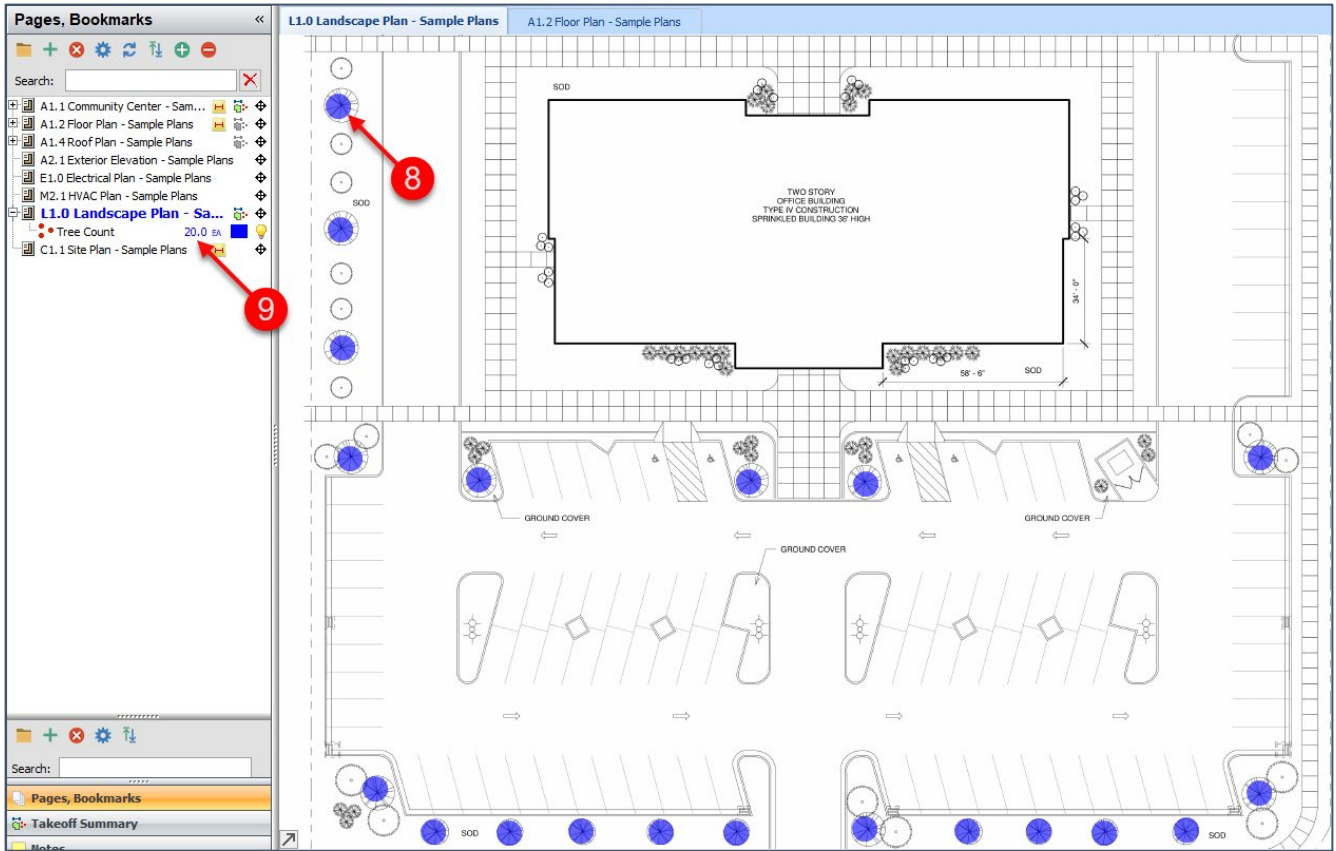

Figure 13-B

---

## Creating a New Section of a Takeoff Item

PlanSwift provides two ways to create new sections of existing takeoffs. The first way creates a **New Section** on the current page using the [New Section](#) button. The second way allows you to use a [Continue With](#) tool to create new sections on any pages (including your current page) and have all of the takeoff values roll up into one total or be broken down into totals for each page. Performing either **New Section** or **Continue With** takeoffs requires familiarity with performing an [area takeoff](#).

### Creating a New Section using the New Section button

The **New Section** button allows you to quickly add one or more new sections to an existing area, linear, segment, or count takeoff on the same page.

To perform a **New Section** area takeoff:

1. Select the takeoff item that you want to add a new section to by clicking on it (Fig. 14-A).
2. Click on the top half of the **New Section** button on the **Home** tab (or press the **N** key on the keyboard, or right-click on an area you want to add a new section to and select **New Section** from the drop-down menu, or double-click on the takeoff item) to start a new section.
3. **Digitizer Record** is now turned on.
4. Perform the takeoff the same as you would perform an area takeoff.
5. Click on the **Digitizer Record** button to turn off record and complete the takeoff. Pressing the **Esc** key or right-clicking and selecting **Stop** from the right-click menu may also be used to turn off record. Note that pressing **Ctrl + Z** will undo the last **Point's** placement.

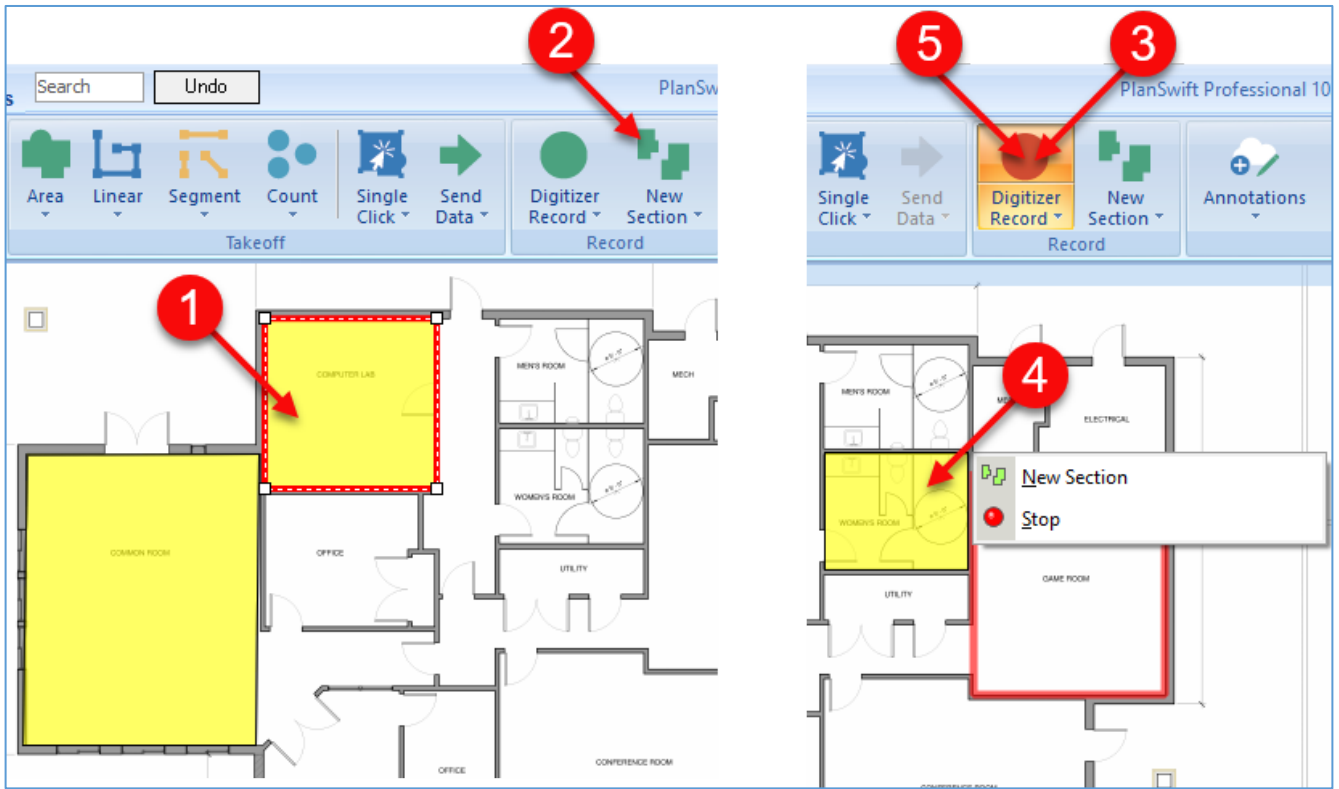

Figure 14-A



## Creating a New Section on a Different Page Using Continue With

The **Continue With** feature allows you to quickly add one or more new sections to an existing area, linear, segment, or count takeoff on a different page (or pages) and keep a running total of the measurements.

1. Go to the page (the **A1.2 Floor Plan**) where you want to takeoff the new section.
2. In the **Pages, Bookmarks** window, hover over a takeoff (**Tile Floor**) that is **on a different page** until the green “**Continue With**” button appears, and click on the green button.
3. This turns on the **Digitizer Record** button. Perform the [takeoff](#) on the **A1.2 Floor Plan**.
4. The new **Floor Tile** takeoff section now also appears on the **A1.2 Floor Plan**.  
Note that the first **Floor Tile** takeoff section measures 830.0 square feet and the second one measures 127.3 square feet.
5. Open the **Takeoff Summary** sidebar window.
6. The total (830.0 + 127.3) of both sections is now displayed, which equals 957.23.

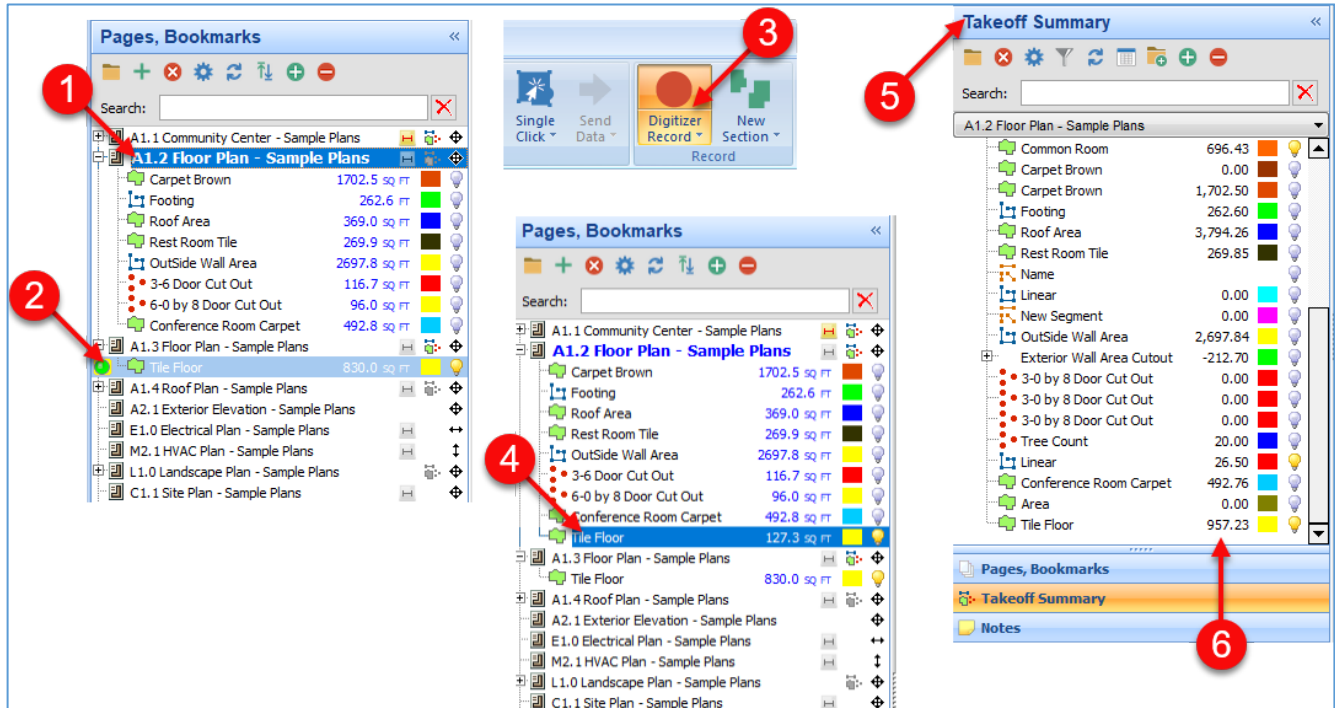

Figure 14-B

The **Continue With** option is also available on two different right-click menus:

1. Right-clicking on any existing takeoff item (Fig. 14-C) and selecting **Continue With**.
2. Or right-clicking anywhere on a page and selecting **Continue With**.
3. Either of these opens the **Continue With** window.
4. Click on the takeoff item (**Tile Floor**), then on **Ok** to turn on **Digitizer Record** so that you can perform a new section takeoff.

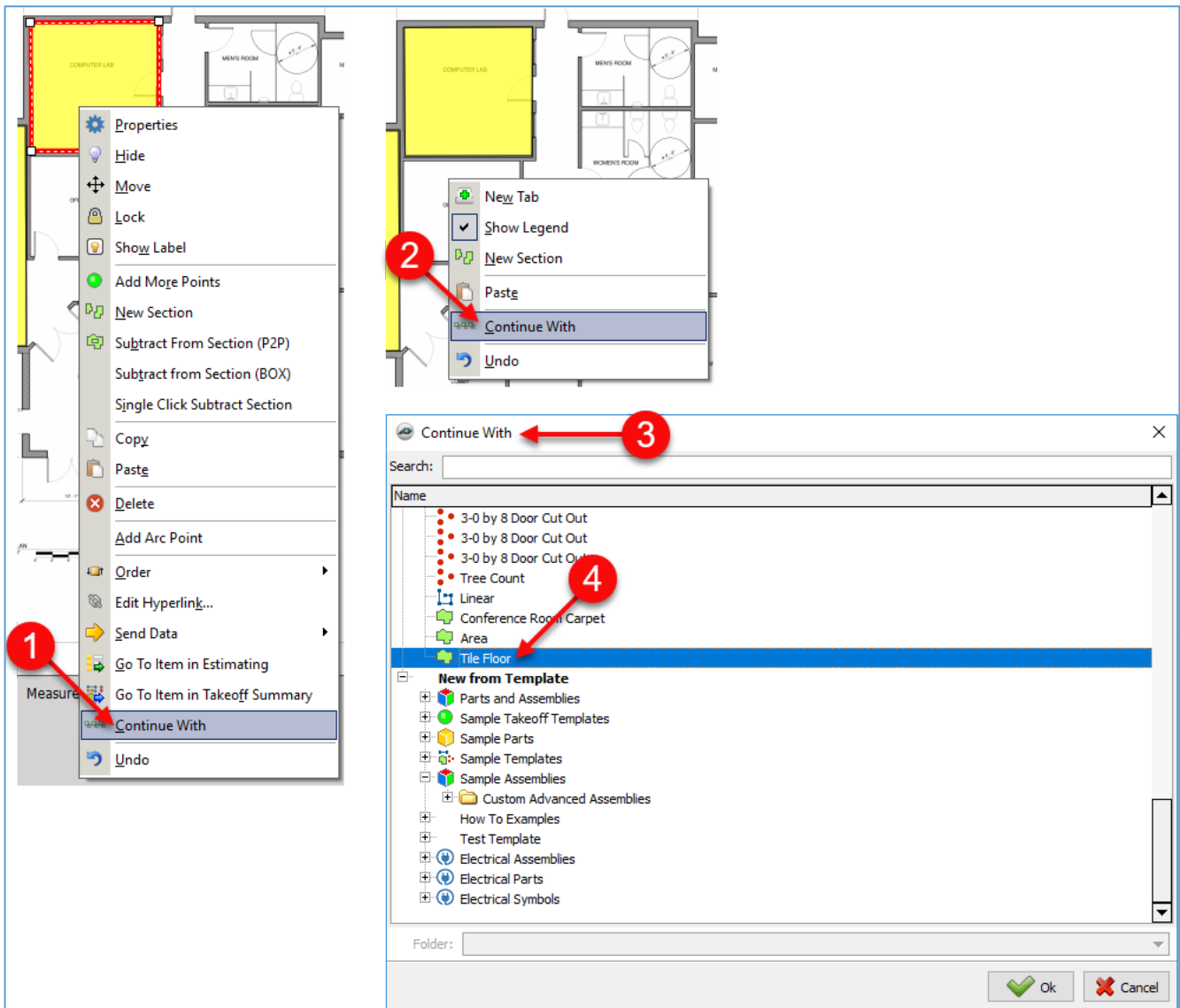

Figure 14-C

## Subtracting from Sections

Performing a **Subtract from Section** takeoff requires familiarity with performing an area takeoff. Subtracting from sections is useful for subtracting areas for things such as islands, countertops, planters, etc. There are two ways to cut out sections. One is with a “[Point-to-Point](#),” and one is with a [Box](#).

### Subtracting Using Point-to-Point (P2P)

To subtract from a section using Point-to-Point:

1. Select the area (by clicking on it) that you want to subtract a section from (see Fig. 15-A).
2. Right-click to display the drop-down menu and select **Subtract from Section (P2P)**.

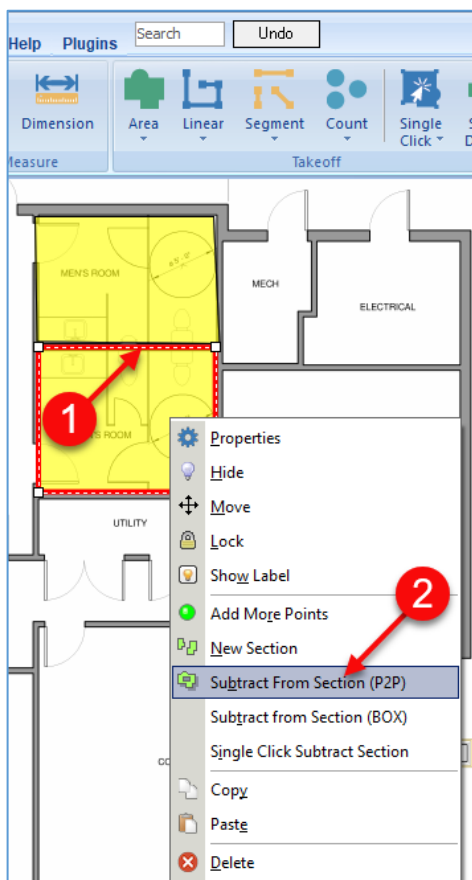

Figure 15-A

3. Perform a takeoff around the area to be subtracted from that section (Fig. 15-B).  
Note that pressing **Ctrl + Z** will undo any **Point's** placement.

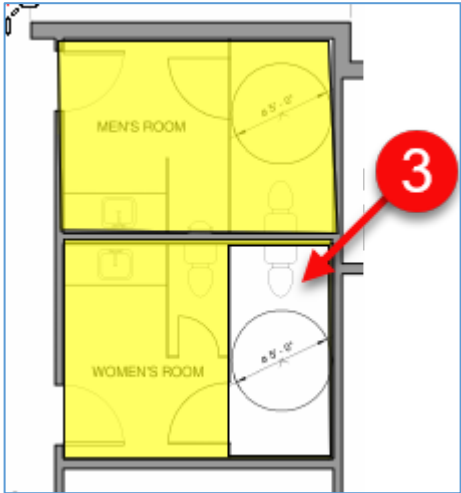

Figure 15-B

## Subtracting Using Box

To subtract from a section using **Box**:

1. Select the area (by clicking on it) that you want to subtract a section from (see Fig. 15-C).
2. Right-click to display the drop-down menu and select **Subtract from Section (BOX)**.

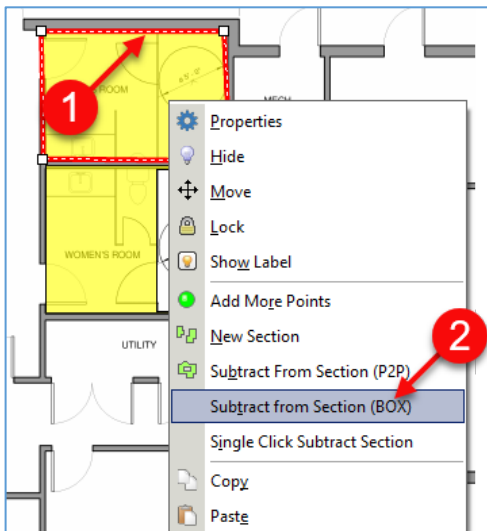

Figure 15-C

3. Click and drag a box over the area to be subtracted from that section. Multiple boxes may be drawn to subtract areas. Pressing **Ctrl + Z** will undo any **Point's** placement. Press **Esc** or right-click and select **Stop** or click on the **Digitizer Record** button to stop the takeoff (Fig. 15-D).

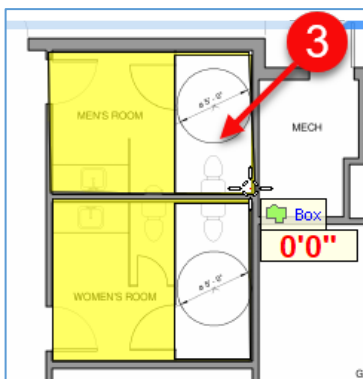

Figure 15-D

---

## Copying and Pasting Takeoff Items

Area, linear, segment, and count takeoff items can all be copied and pasted. Copying and pasting takeoff items require familiarity with performing takeoffs and can save considerable time in performing repetitive takeoffs. One or more items can be selected and copied either into an existing item or into a new item. Items can also be copied at specified increments in any direction (from 0 to 360 degrees). Pasted items may need to be moved. Moving items is covered in [Moving a Takeoff Item](#).

## Copying and Pasting One or More Takeoff Items

To copy one or more items:

1. Select the item or items you want to copy by either clicking on them while holding the **Shift** or **Ctrl** key or by dragging a box over the items (Fig. 16-A).
2. Right-click on one of the selected items and select **Copy** from the drop-down menu to copy the items.
3. Right-click on the upper-left **Point** where you want the new item to be pasted.
4. Click on **Paste** to open the **Confirm Copy Section** window.
5. If you want the copy to be pasted into the same item, select **Paste sections into same item**. If you want it pasted into a new item, select **Paste sections into a new item**.
6. Click on **Ok** to paste the stored item or items.
7. The copied items appear at the location clicked on in Step 3.

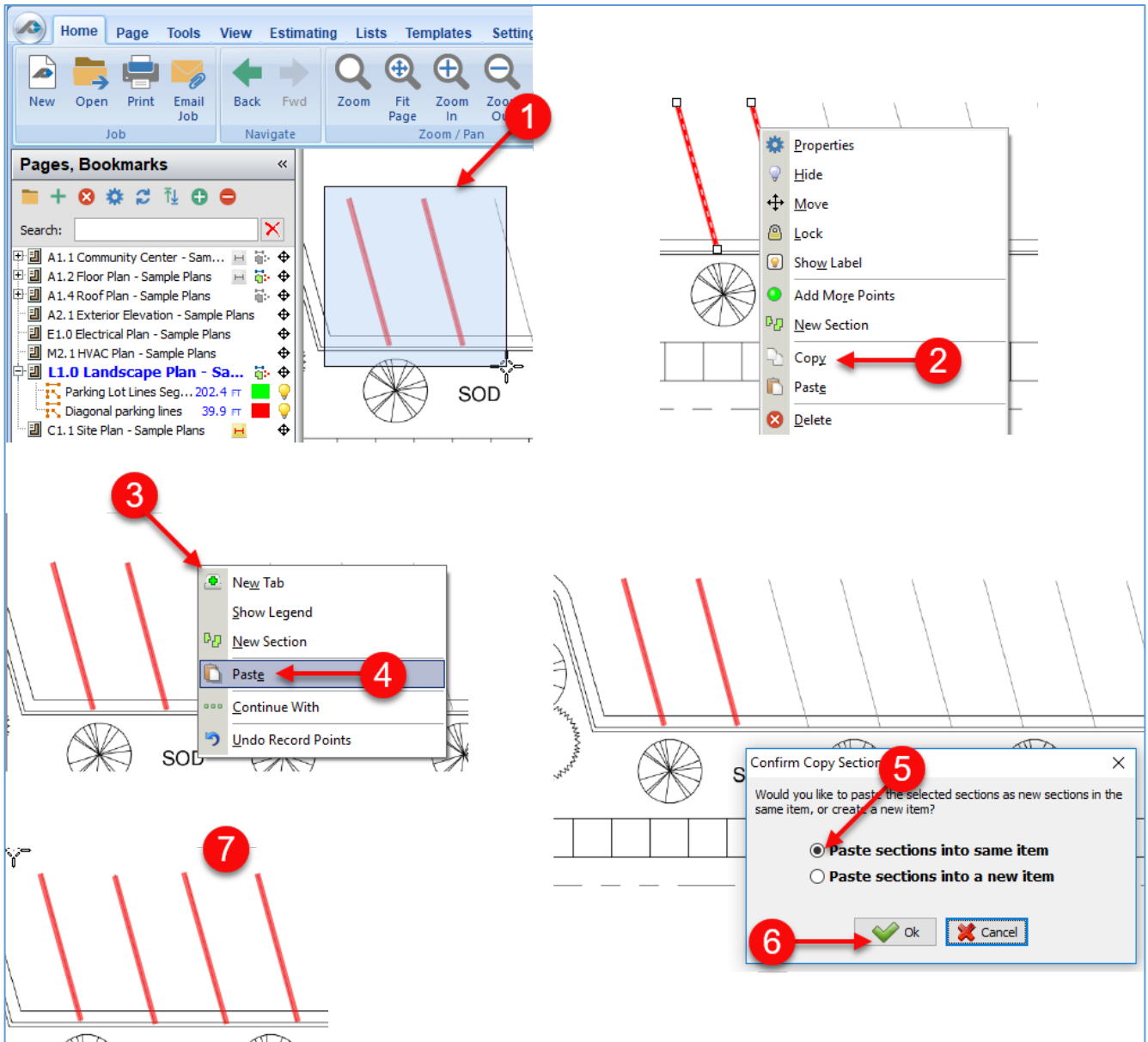

Figure 16-A

---

## Using Linear Copy to Paste Takeoff Items in a Specified Direction

Performing a linear copy and paste is Initiated only by a hotkey. To copy a takeoff item (or items) and paste them in a specific direction:

1. Select the takeoff item (or items) to be copied (in this case a linear parking diagonal line) (Fig. 17-A).
2. Press **Ctrl + Right Arrow** key on the keyboard to open the **Move Objects** window.
3. Enter the distance to the right that you want the copied item to be placed (this can be determined using the [Dimension](#) tool if you do not know the distance). These parking lines are 9' 3-7/8" apart.
4. Enter the angle that the copies are to be laid out. The **Right-Arrow** key is 0 degrees, **Left** is 180, **Up** is 90, and **Down** is 270; any angle, such as 95 or 187 degrees, is also acceptable. For this example, use 0.00 degrees.
5. Click on **Ok**.
6. In the **Linear Copy** window, enter the number of copies of the item (10).
7. Click on **Ok**.
8. The ten linear takeoffs are now copied.
9. The total linear value of the 11 parking diagonals is 221.7 FT.



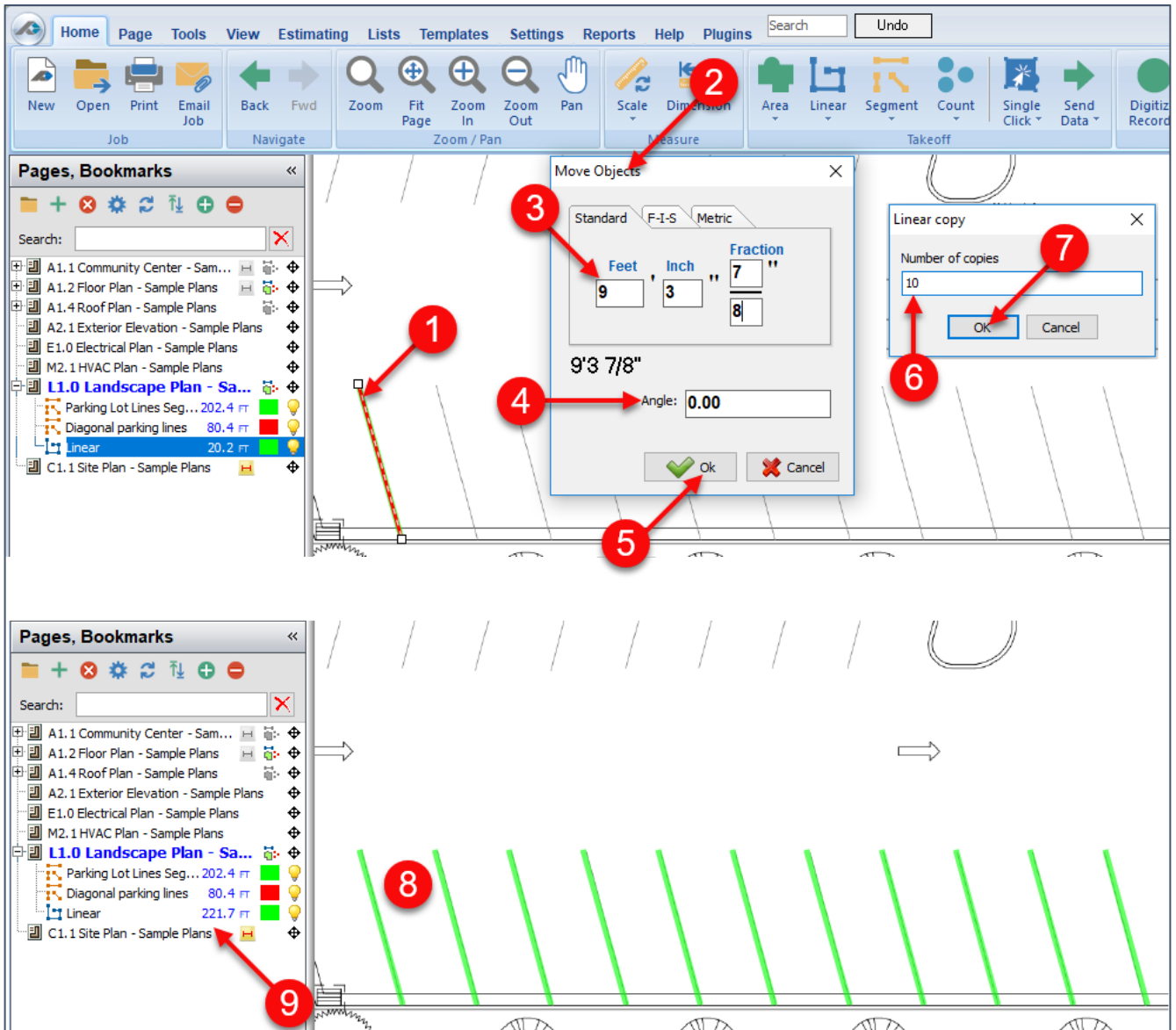

Figure 17-A

## Manipulating Points

### Using Snap, Ortho, Freehand, and Verify Points

1. The [Snap](#), [Ortho](#), [Freehand](#), and [Verify Points](#) tools are at the bottom of the PlanSwift window. They can be clicked on at any time to toggle them on (highlighted) or off (un-highlighted) (Fig. 18-A). Each of them is discussed below.



Figure 18-A

### Using Snap

Snapping is useful for creating takeoffs using **Points** from previously created takeoffs or CAD drawings. To turn on **Snap**, click the **Snap** button or press **F3** on the keyboard. **Snap**, when turned on, snaps the cursor to the nearest **Point** when your cursor crosshairs get close to that **Point**. When a **Point** is snapped to, a red square marker appears on that **Point**. When that marker is visible, clicking will automatically match your new takeoff to the existing **Point** (Fig. 19-A). Note: snapping works only for existing **Points** created in PlanSwift and for CAD **Points** on imported CAD drawings but will not work for vector **Points** on imported PDF or TIFF drawings.

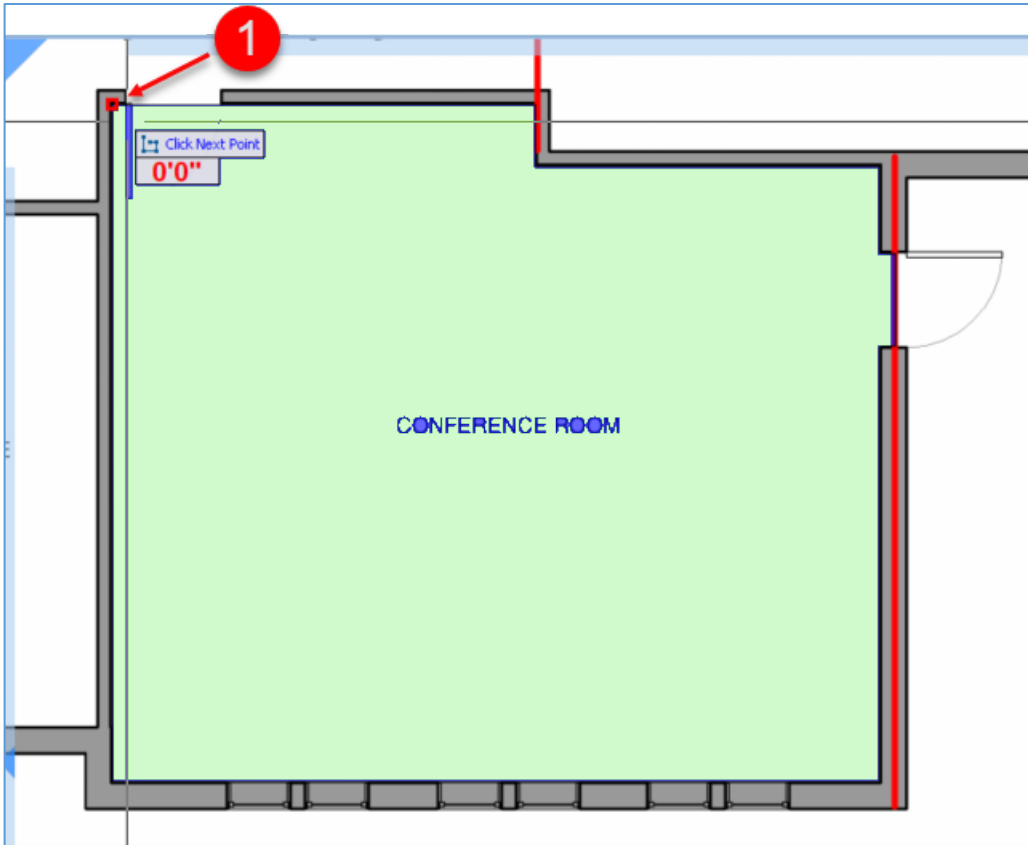

Figure 19-A

## Using Ortho

Ortho makes it easy to keep lines at 90-degree or 45-degree angles. To turn **Ortho** on, click the **Ortho** button or press **F8** on the keyboard. Note: **Ortho** can be temporarily enabled or disabled anytime by holding the **Shift** key on the keyboard. With **Ortho** turned on, when you begin to get close to either a 90-degree or a 45-degree angle, the cursor automatically jumps to the 90- or 45-degree position. In Figure 20-A, if the cursor is moved any closer to the 90-degree horizontal wall than it already is (see #1), then it will automatically jump to the wall (see #2). Observe that the cursor is just a bit closer to the wall (see #3) than it was for #1. Ortho makes it easy to ensure that vertical lines stay vertical and horizontal lines stay horizontal.

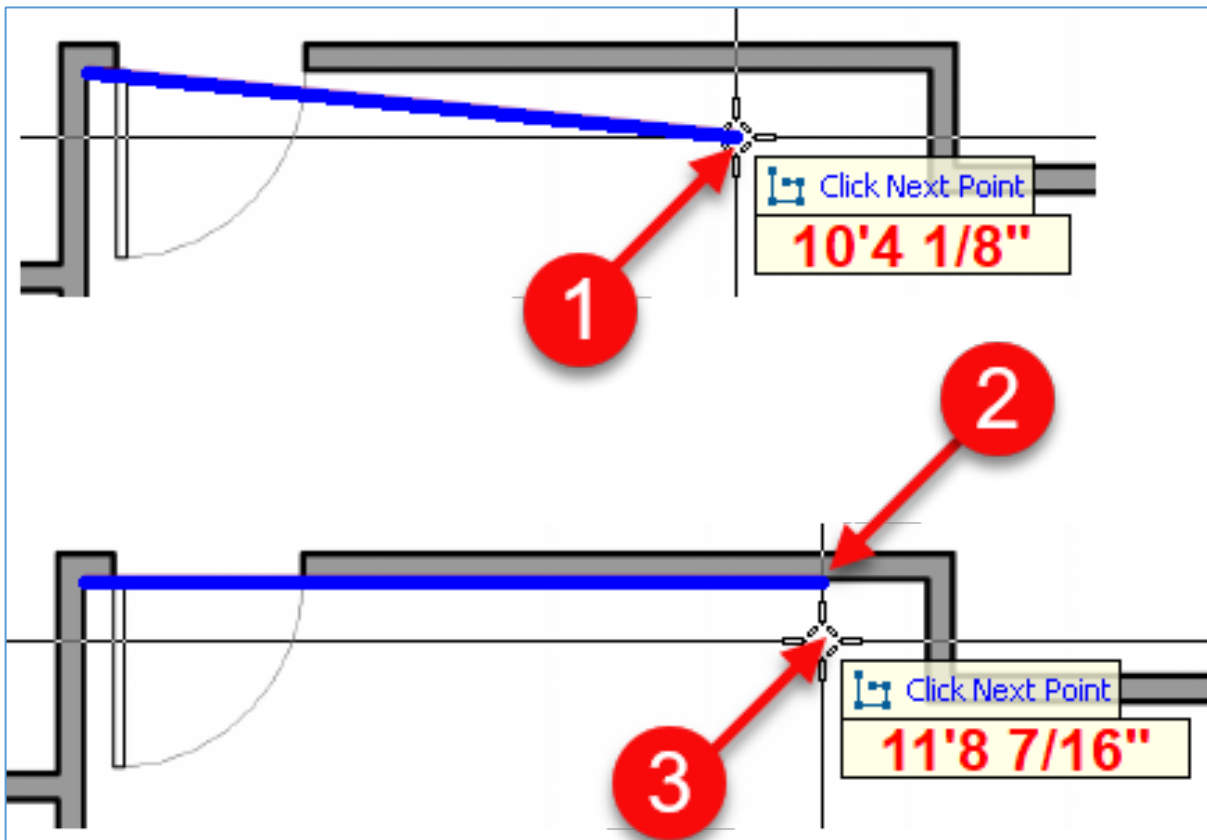

Figure 20-A

## Using Freehand

Freehand can be useful for curved areas, such as bushes or gardens or even electrical wires where a freehand style might be useful. It is only available for use with **Area** and **Linear** takeoffs. To perform a freehand takeoff:

1. Click on the **Freehand** button to toggle freehand to on (Fig. 20-B).
2. Click on the **Linear** takeoff button (or click on **Area** to do an area freehand).
3. Enter a name for the electrical circuit in the **Properties – [Linear]** window (for areas it is the **Properties – [Area]** window).
4. Select a color for the takeoff.
5. Click on **Ok**.

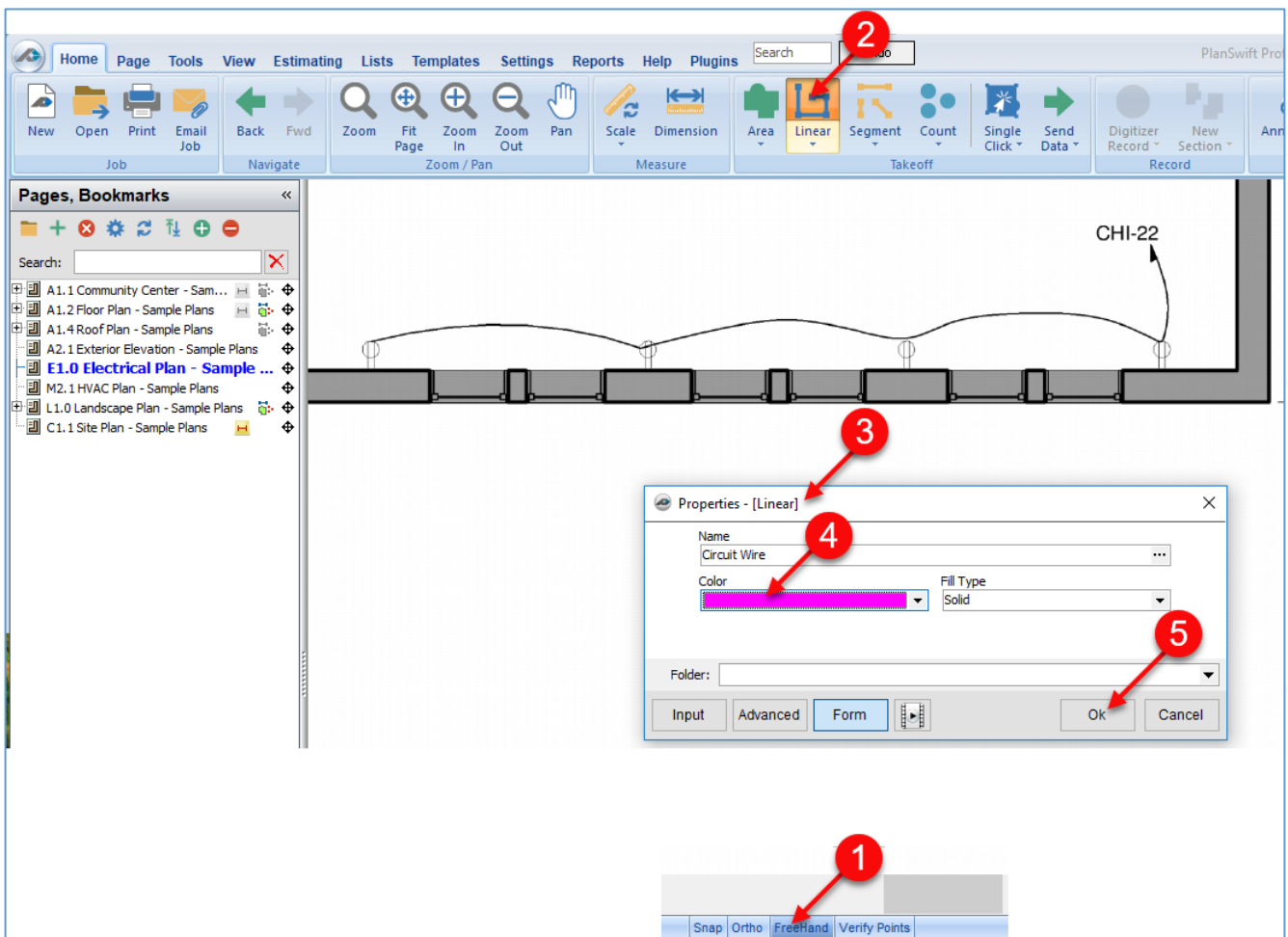

Figure 20-B

6. Click on the beginning of the electrical wire and *hold the mouse button down* until “Freehand” appears and begin moving your mouse freehand (Fig. 20-C). Note: if you make a mistake, release the mouse button, then press the **Backspace** key on the keyboard as many times as necessary to correct the mistake; to continue freehand, hold down the mouse button as before.
7. Complete the freehand drawing and press **Esc** (or the **C** on the keyboard or right-click and select **Stop** from the drop-down menu) to end the takeoff.
8. The takeoff measures 22.7 FT.

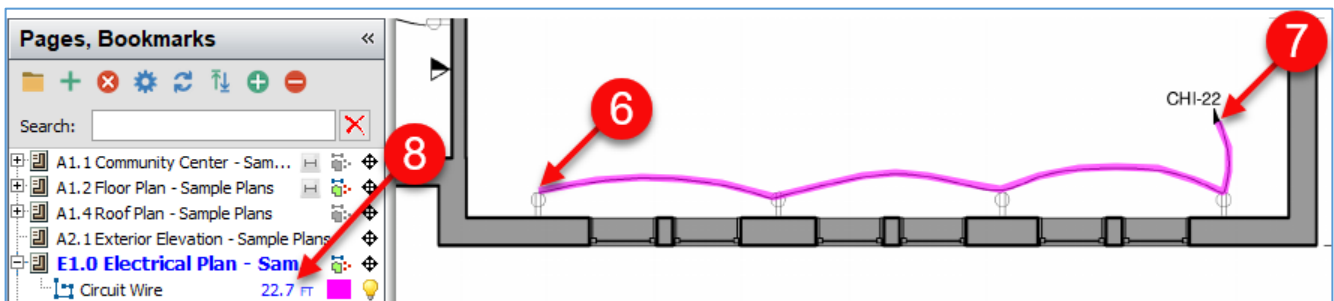

Figure 20-C

## Using Verify Points

**Verify Points** can make takeoffs more accurate. To turn on **Verify Points**, click **Verify Points** or press **F6** on the keyboard. **Verify Points** will not work with **Freehand** enabled. With **Verify Points** enabled, each time you digitize a **Point**, a window will pop up called **Verify Entry**. The **Verify Entry** window (Fig. 21-A) has two tabs that allow you to specify distance and angles in two ways:

1. The **Horizontal & Vertical** tab allows you to specify by horizontal and vertical distances. In Figure 21-A, the roof line takeoff (see #3) in blue measures 24' 8" horizontally and 10' 4" vertically. If you want to change the values, enter the new values and click on **Ok**.
2. The **Angle & Distance** tab allows you to specify by slope angle and slope distance. In Figure 21-A, the roof line takeoff (see #3) slope distance is 26' 9"; its slope angle is 22.7 degrees. If you want to change the values, enter the new values and click on **Ok**.

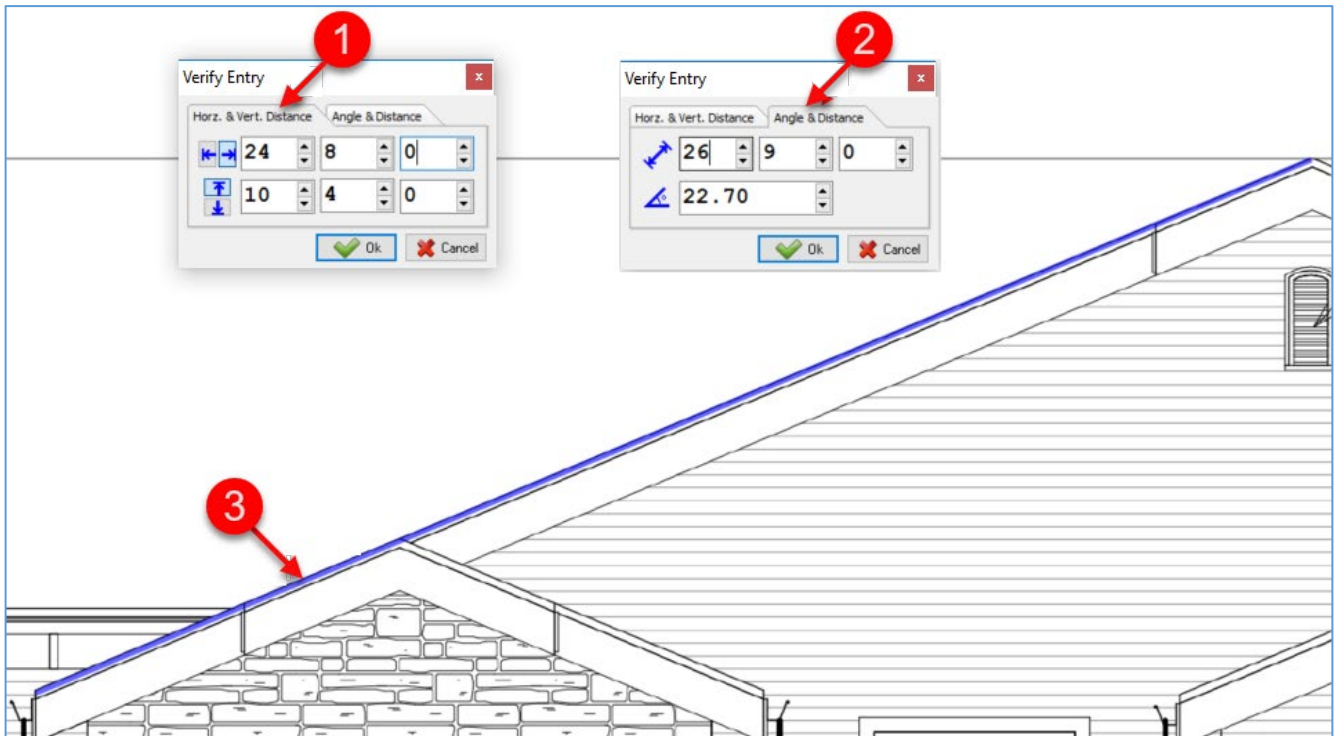

Figure 21-A

## Moving Points

PlanSwift provides a way to move a **Point** to a specified location. To move a **Point**:

1. Click on the **Point** you want to move, then click on an **Arrow** key on the keyboard that corresponds to the direction you want the **Point** to be moved (in this case the right-arrow key) (Fig. 22-A).
2. This opens the **Move Points** window.
3. Enter the distance in feet, inches, and fractions that you want the **Point** moved to the right. In this case, enter 2', 0".
4. To change the angle, enter the angle in degrees in the **Angle** field. Enter 22.
5. Click on **Ok**.
6. The **Point** is now moved to the peak of the roof.

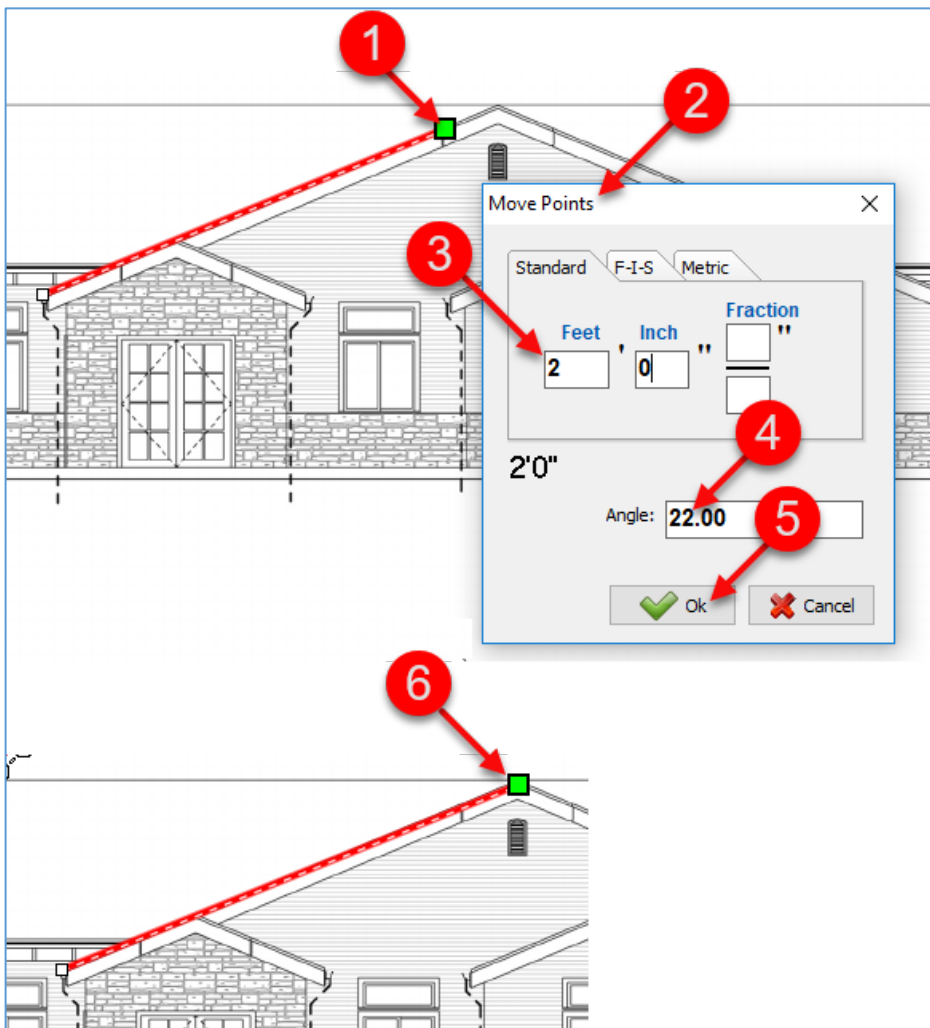

Figure 22-A



## Moving a Takeoff Item

PlanSwift provides several ways to move one or more takeoff items. This is particularly useful after copying and pasting a takeoff item and it isn't in the correct position.

### Moving Takeoff Items to a Specified Location

To move takeoff items to a specified location:

1. To select a takeoff item, click on the item you want to move. To select multiple items, hold Shift and click on each of the items (either in the **Pages, Bookmarks** window or on the drawing itself), or click and drag the cursor over the items to select them. Click on an **Arrow** key on the keyboard that corresponds to the direction you want the items to be moved (in this case the right-arrow key) (Fig. 22-B).
2. This opens the **Move Objects** window.
3. Enter the distance in feet, inches, and fractions that you want the **Point** moved to the right. In this case, enter 2'".
4. To change the angle, enter the angle in degrees in the **Angle** field. Leave this value at zero.
5. The takeoff of the two items is now moved to the right 2'.

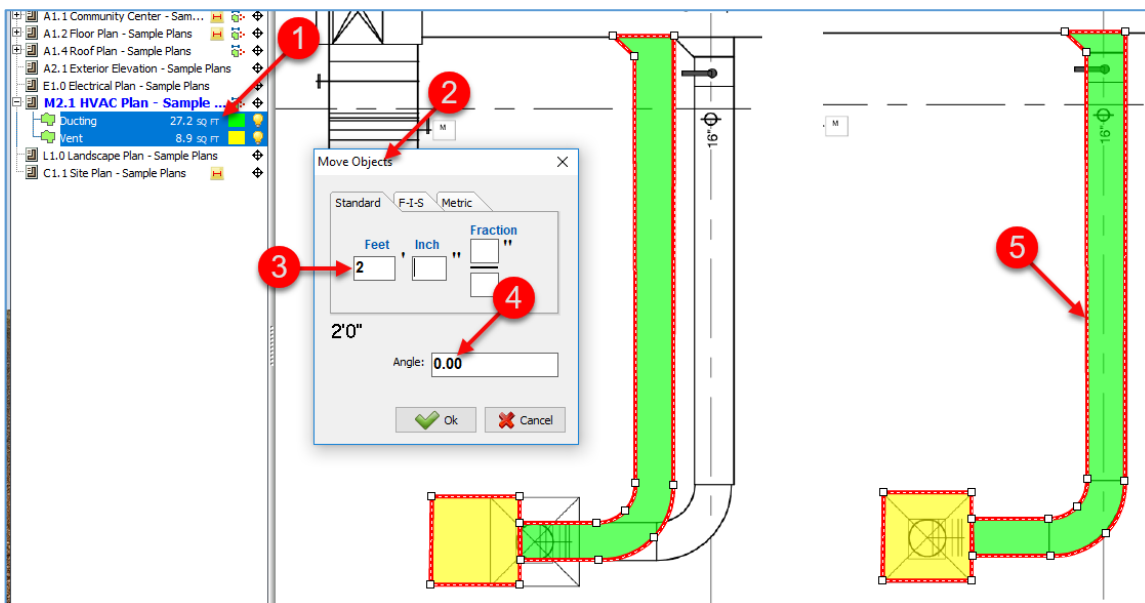

Figure 22-B

## Moving Items with the Mouse

To move items with a mouse:

1. Select the takeoff item or items as described under [Moving Takeoff Items to a Specific Location](#).
2. Hold down the **Alt** key, left click on the item (or items), and drag the mouse to move the item or group of items to a new location.

## Moving Items Using the Right-Click Menu's Move Selection

To move items with the right-click menu move selection:

1. Select the takeoff item or items as described under [Moving Takeoff Items to a Specific Location](#) (Fig. 22-C).
2. While holding the cursor directly over one of the selected takeoff items, right-click the mouse to open the right-click drop-down menu.
3. Select **Move** from the drop-down menu.
4. Left-click and hold on any of the selected items and drag the mouse to move the item or items to a new location.

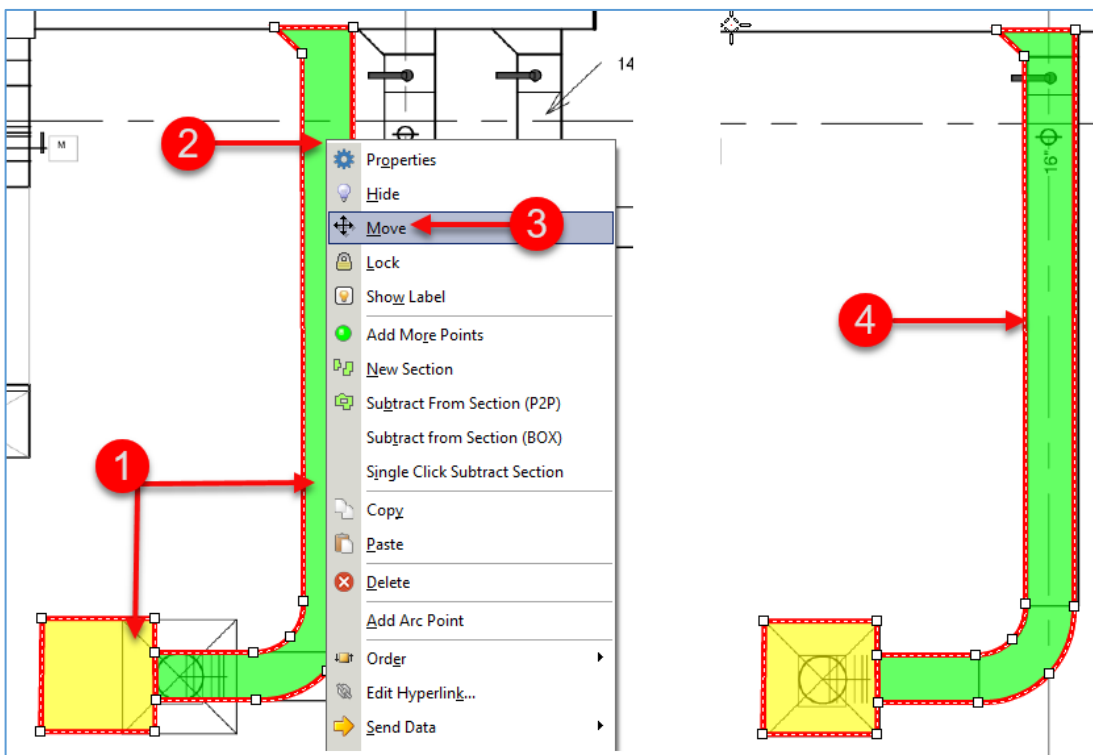

Figure 22-C

## Establishing Points While in Digitizer Record Mode

PlanSwift allows you to specify the distance and angle of the next **Point** for an **Area**, **Linear**, **Segment**, or **Count** takeoff using the **Add Line** command:

1. The **Digitizer Record** must be on (showing red).
2. After clicking to establish a **Point** for a takeoff, press an **arrow** key to establish the general direction of the next **Point**. This opens the **Add Line** window (Fig. 22-D),
3. Enter the distance and angle of the next **Point**.

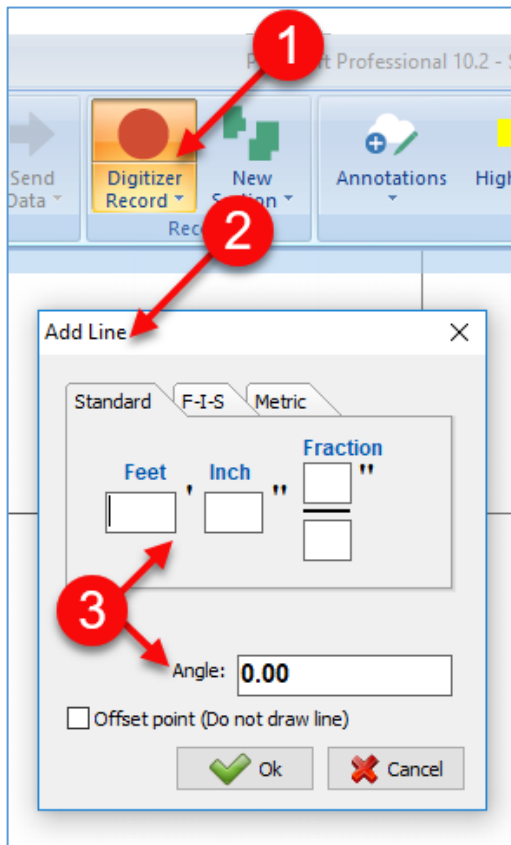

Figure 22-D

## Creating Arcs with Areas, Linears, and Segments.

Creating an arc line requires familiarity with performing an [area takeoff](#). Areas, linears, and segments may all utilize arcs, and the method for creating arcs is the same, whether it is an area, liner, or segment arc.

## Area Arc

To perform an area arc:

1. Click on the top half of the **Area** button on the **Home** tab (Fig. 23-A).
2. Enter a name for the takeoff.
3. Select a color and click on **Ok** to begin the takeoff.
4. Click on the first **Point**.
5. Click on the second **Point**, which begins the first arc, then press the **A** key on the keyboard. Note that pressing **Ctrl + Z** will undo any **Point's** placement.
6. Click on the middle of the arc for the third **Point**.
7. Click on the fourth **Point**, which is the end of the first arc (this creates a smooth arc line).

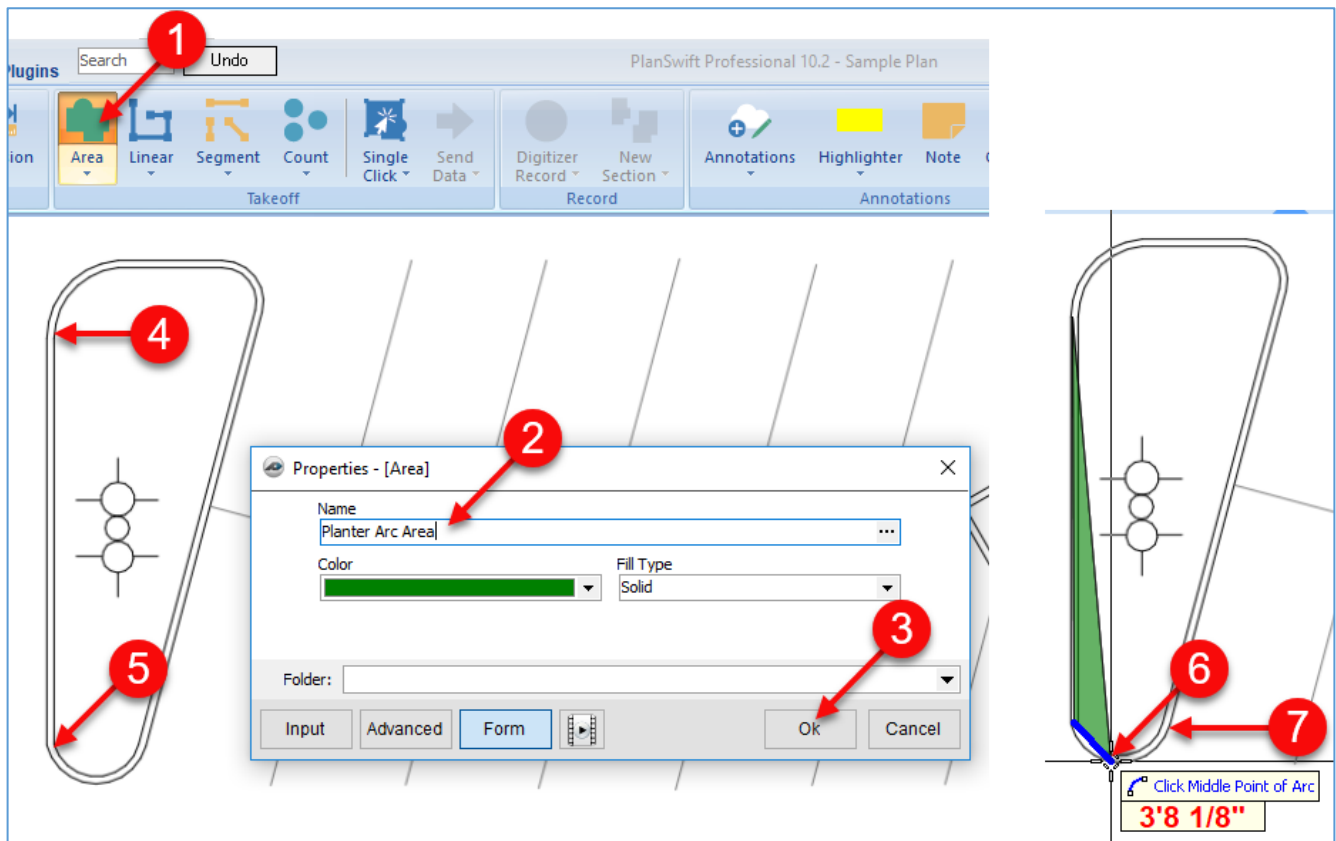

Figure 23-A

8. Click on the fifth **Point**, which completes the straight line to the second arc and press the letter **A** again (Fig. 23-B).
9. Click on the middle of the arc.
10. Click at the end of the arc (this completes the second arc).
11. Complete the straight line and press the letter **A** again.
12. Click on the middle of the final arc.

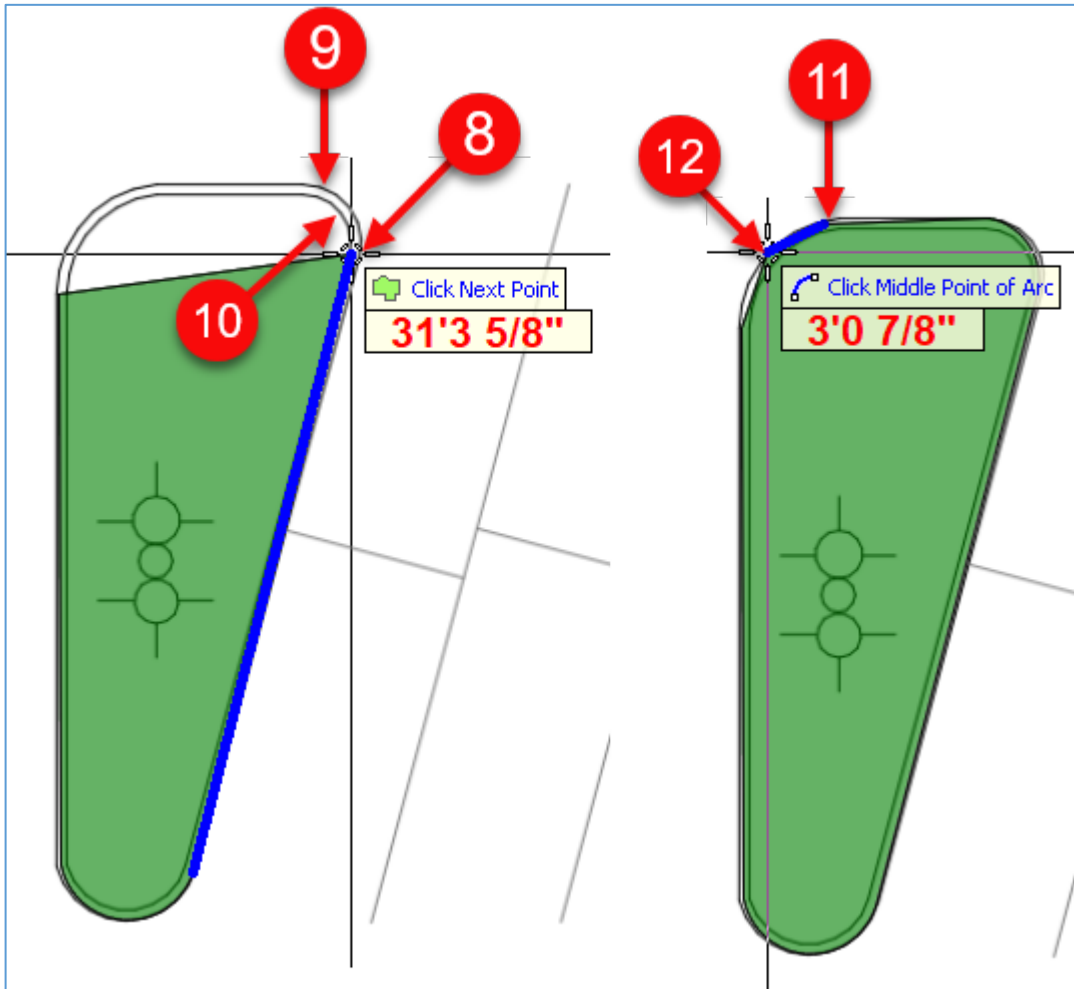

Figure 23-B

13. Complete the takeoff by pressing the **Esc** key (or by clicking on **Digitizer Record** button or by right-clicking and selecting **Stop** from the drop-down menu or by pressing the letter **C** on the keyboard) (Fig. 23-C).
14. Click on the takeoff again, and each of the arc **Points** is visible.

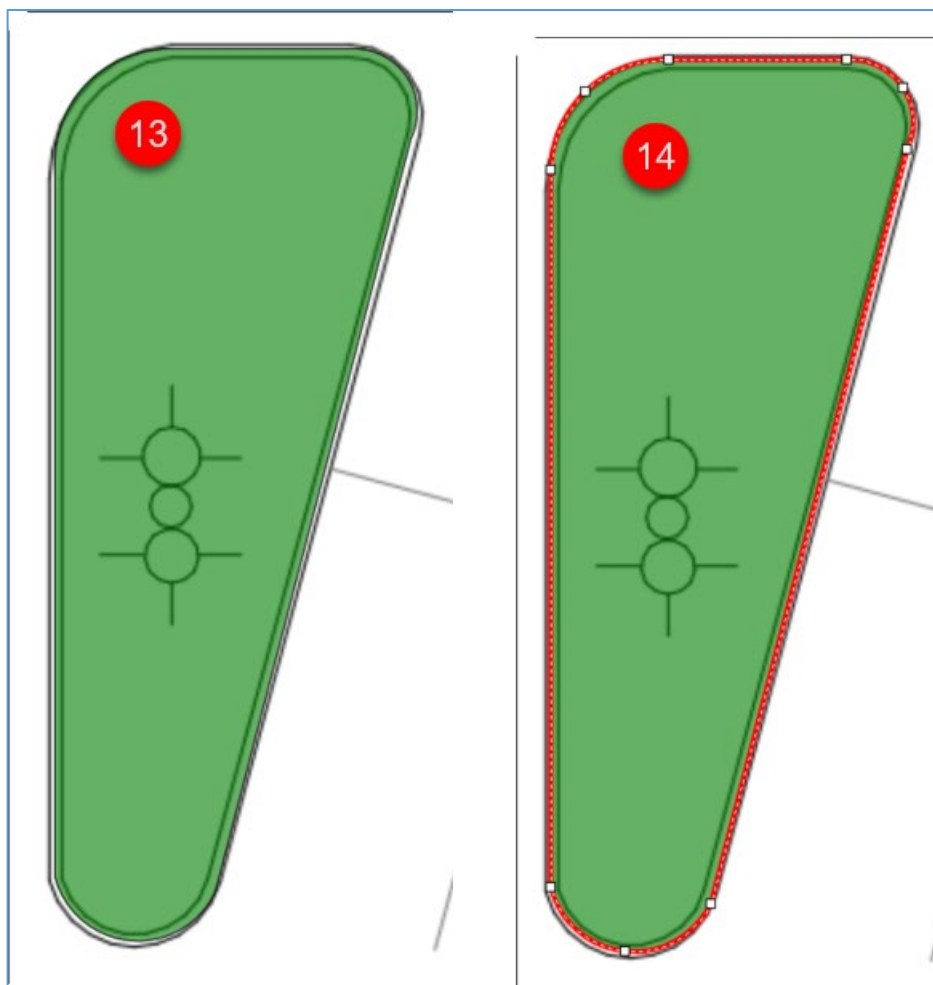

Figure 23-C

## Linear and Segment Arcs

Drawing linear and segment arcs work identically to an [area arc](#), except that you select top half of the **Linear** button or the top half of the **Segment** button on the **Home** tab menu.

## Creating Closed Circles with Areas and Linears

PlanSwift makes drawing area and linear circles simple. To draw a linear circle with a 50-foot diameter:

1. Click on the top half of the **Linear** button on the **Home** tab ribbon bar (Fig. 24-A).
2. This opens the **Properties - [Linear]** window.
3. Enter a name for the linear circle.
4. Select a color for the item.
5. Click on the **Point** where the circle is to begin (we'll place this linear circle over a 50' dimension line).

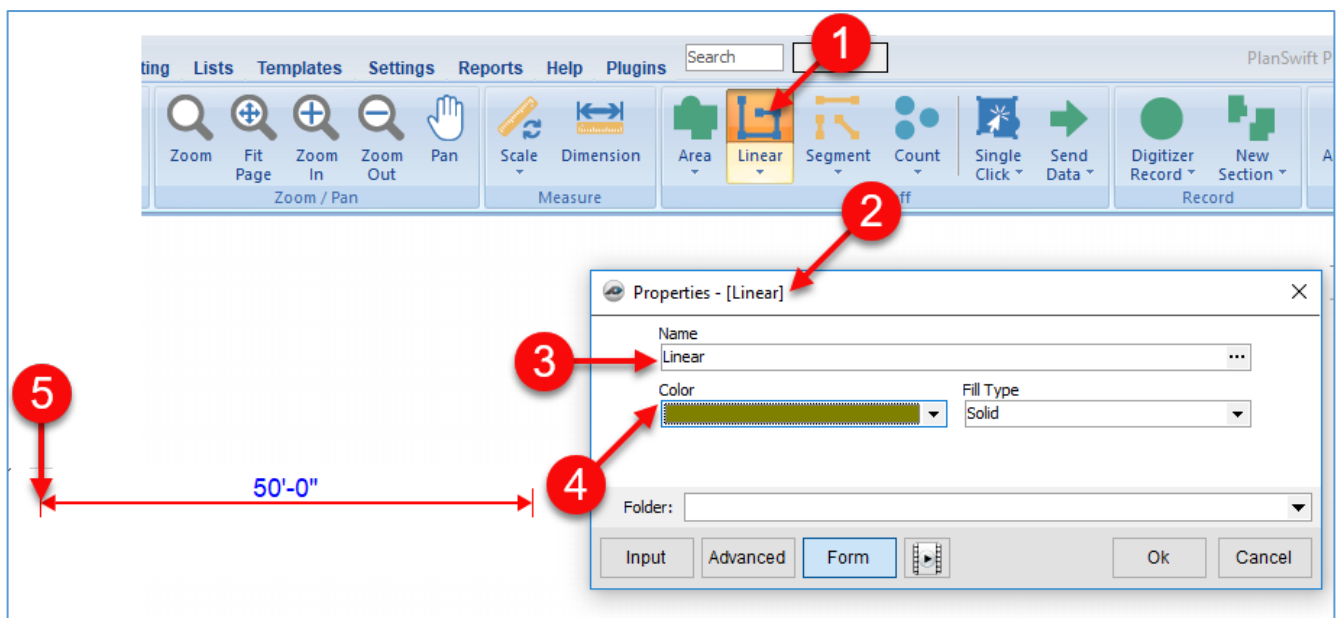

Figure 24-A

6. Press the **A** key on the keyboard to specify an arc, and then click on where the circle diameter should extend to (Fig. 24-B). This defines the middle **Point** of the circle's arc. The diagram shows the magnifier (pressing letter M on the keyboard) being used to more accurately place the middle **Point**.
7. Move the cursor anywhere off that **Point** and then press the **C** key to close the arc.
8. The linear circle is completed and closed.

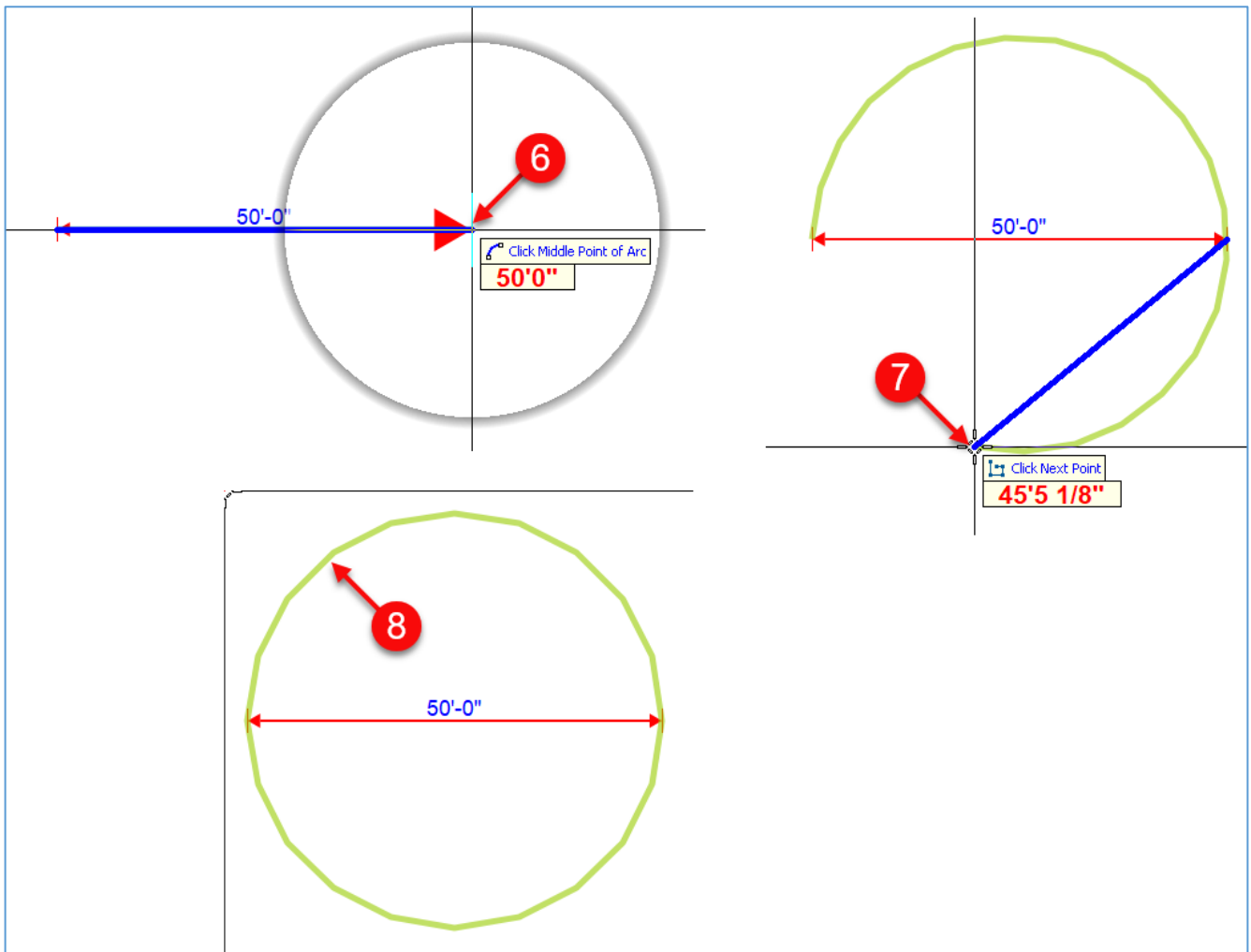

Figure 24-B



---

## Creating Annotations

Annotations such as [dimensions](#), [notes](#), [legends](#), [revision clouds](#), [rubber stamps](#), [sticky tabs](#), [highlights](#), and [images](#) can be very helpful when estimating. Default settings for label, note, dimension, legend, and highlighter annotations may be changed under **Annotations** in the **Settings** tab of PlanSwift.

## Adding and Specifying Dimensions

The **Dimension** tool is useful to determine dimensions or to specify dimensions of most any aspect of items on plans or pages. Note that the **Dimension** tool does not store measurements in a way that is practical to use for estimating. When doing takeoffs, use the **Area**, **Linear**, **Segment**, and **Count** tools, not the **Dimension** tool, to digitize and store measurements on pages.

## Adding Dimensions

To add a dimension:

1. To add a dimension for a section of a building, click on the **Dimension** button on the **Home** tab ribbon-bar (Fig. 25-A).
2. Click on the first **Point**, using the crosshairs to line up the dimension. It may also be helpful to press the **M** key on the keyboard to magnify the area for a more accurate dimension.
3. Click on the second **Point** of the dimension to complete that dimension. You can now click a new **Point** to start another dimension or press **Esc** to end the dimension tool.

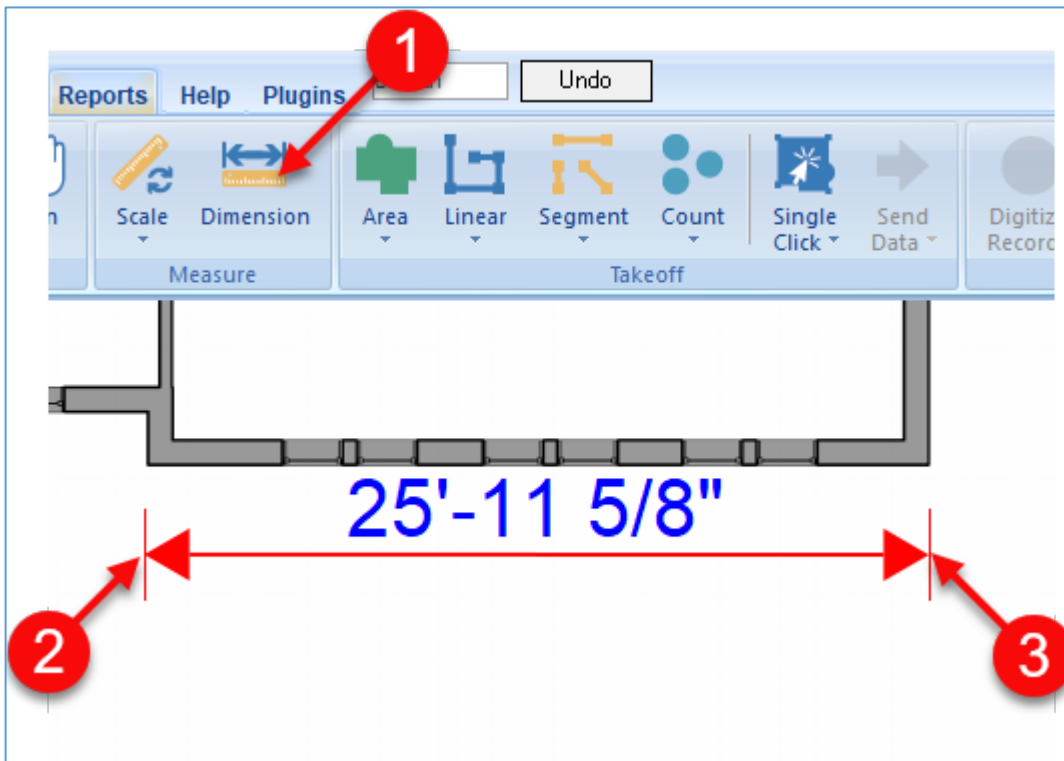

Figure 25-A

---

## Specifying Dimensions

To specify a dimension:

1. To specify a dimension, click on the **Dimension** button on the **Home** tab ribbon-bar (Fig. 25-B).
2. Click on the first **Point** where you want the dimension to begin.
3. Click on an **Arrow** key (**Right**, **Up**, **Left**, or **Down**) on the keyboard for the general direction that you want the dimension line to go. This opens the **Add Line** window.
4. Enter the distance in **Feet, Inches, and Fractions** of an inch for the dimension.
5. If you selected the **Right** arrow key in step three, the **Angle** field will display as 0. **Up** would display as 90 degrees, **Left** as 180 degrees, or **Down** as 270 degrees. Alternately, you can enter any value between 0 and 360 degrees into the **Angle** field.
6. If you want to offset the dimension, check the **Offset point** box.
7. Click on **Ok** to draw the dimension line. If you clicked on the **Offset point** box, then the dimension line will not be drawn; rather, the starting **Point** will be offset by the **Feet, Inch, Fraction** value, and you can now press an **Arrow** key (back to Step 3) to begin the dimension line from the new offset location.
8. A dimension line specified at 35' 8" and 10 degrees is shown.

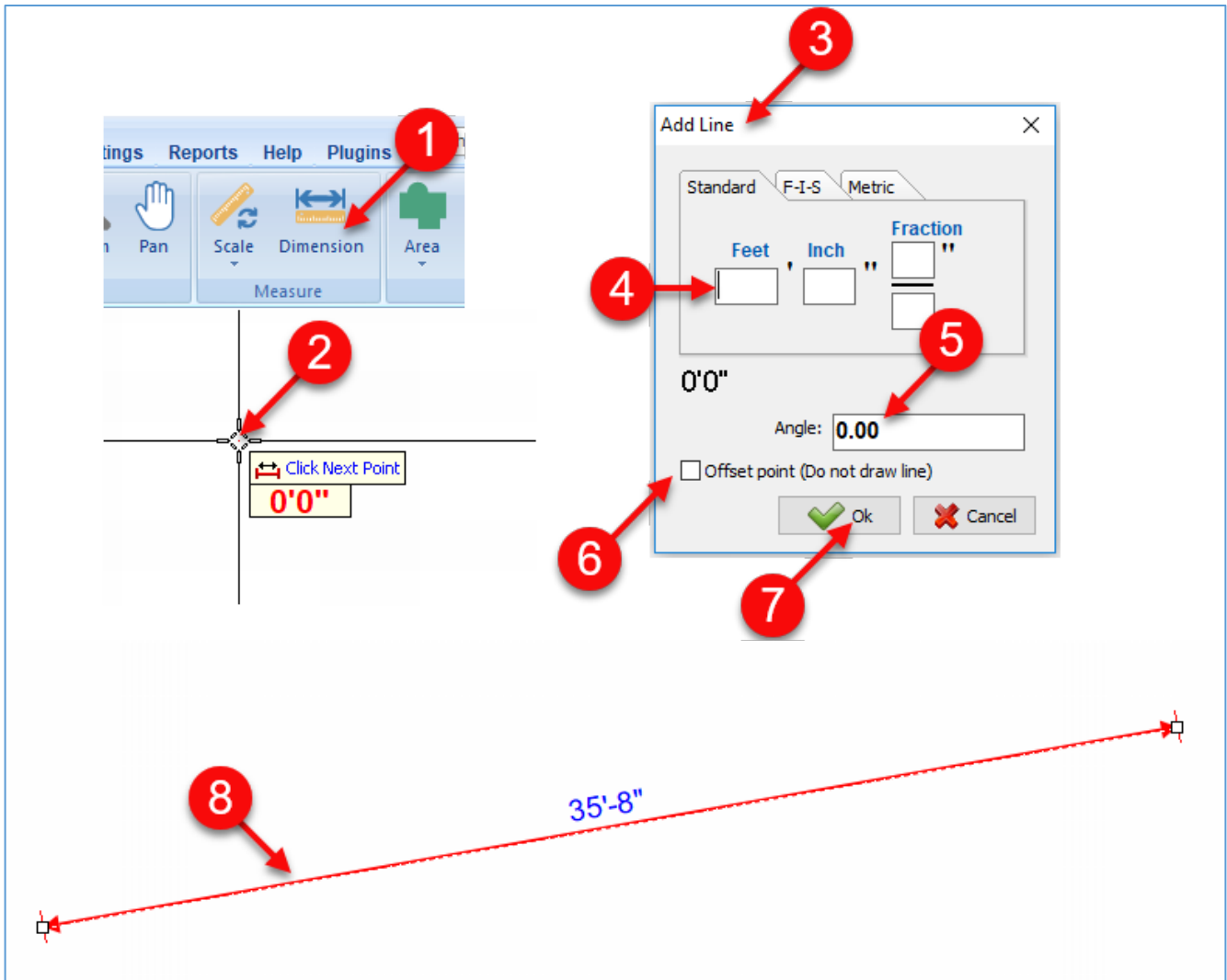

Figure 25-B

## Adding Notes

The **Notes** tool is useful to place notes on pages. To create a note:

1. Click on the **Note** button in the **Annotations** group on the **Home** tab ribbon-bar (Fig. 26-A).
2. Click and drag over area where you want to place the note.
3. This opens the **Properties – [New Note]** window.
4. In the **Text** field, type the text of the note.
5. Most of the fields are self-explanatory. Enter the text size (in pixels) or use the default of 1. Note the default text sizes can be changed in the [Settings](#) of PlanSwift.

6. Click on the **Scaled** checkbox if you want the note's text size to be scaled to the scale of the page.
7. The **Auto Size** checkbox automatically sizes the note to be no larger than needed for the note itself.

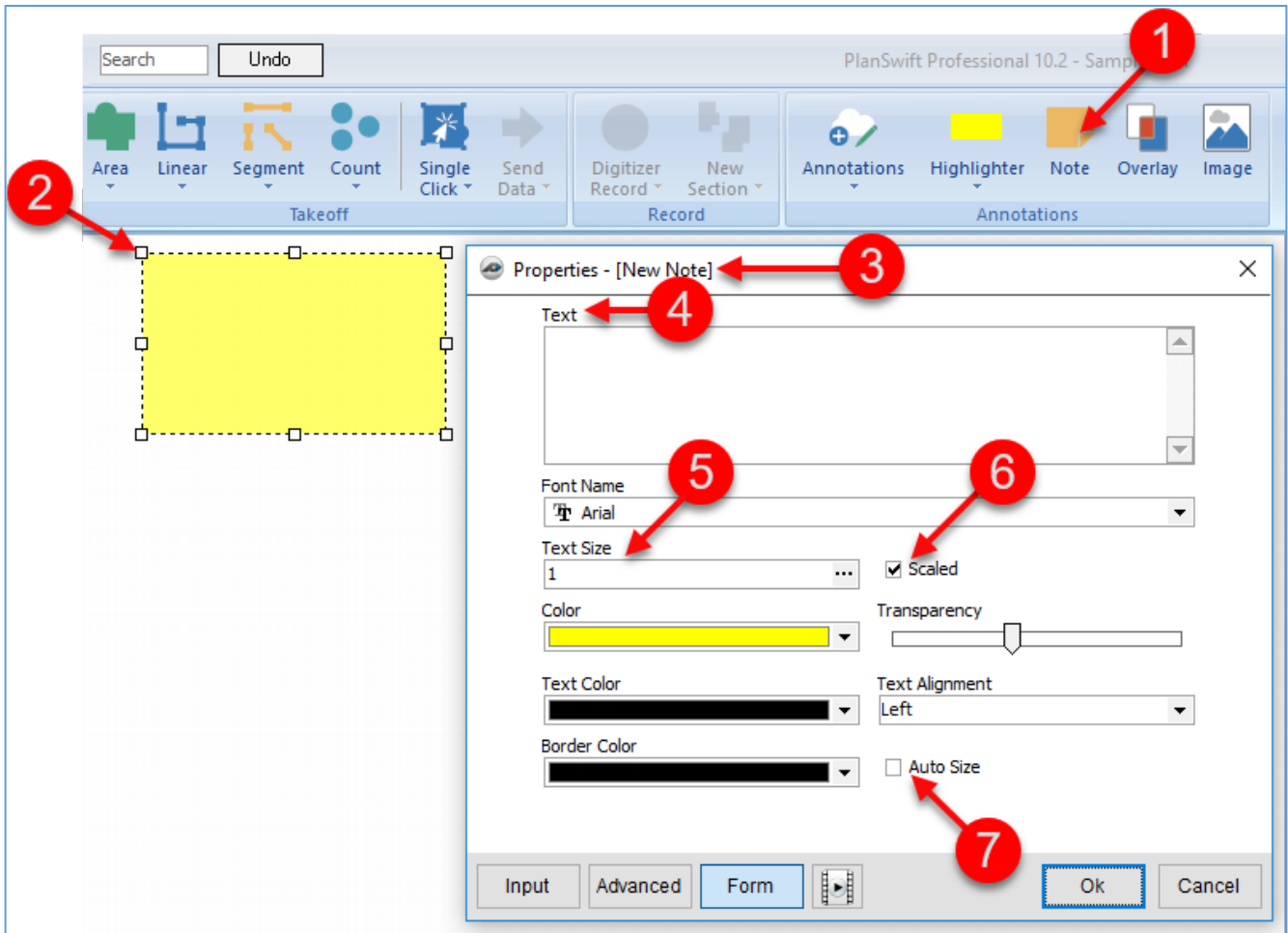

Figure 26-A

# Showing a Legend

Legends containing takeoff names and values may be placed anywhere on a page. By default, the legend is not displayed. The default can be changed in the PlanSwift settings. To display the legend:

1. Right-click on any non-takeoff area on the page (Fig. 27-A).
2. From the drop-down menu, click on **Show Legend** to display the legend.
3. The legend appears in the bottom-left corner of the plan.
4. The size of the legend can be changed by clicking on the legend and dragging any of the eight selectable **Points**. It can be moved by clicking and dragging on it. Clicking on it and pressing delete allows you to delete the legend. Pressing **Ctrl + Z** will undo any action performed on the legend.

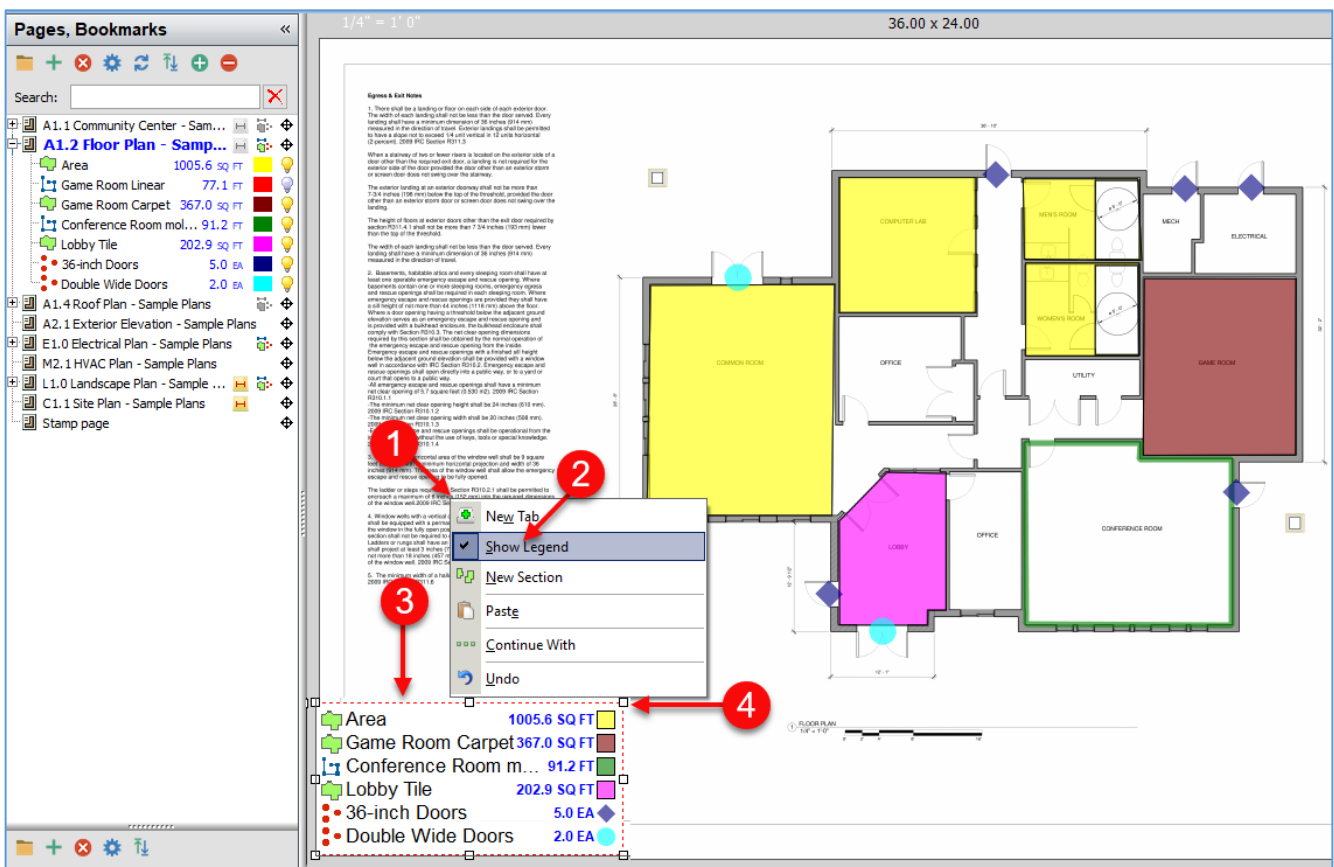

Figure 27-A

## Adding Revision Clouds, Rubber Stamps, Sticky Tabs, Highlights, and Images

[Revision clouds](#), [rubber stamps](#), [sticky tabs](#), [highlights](#), and [images](#) allow for considerable flexibility in annotating your pages.

### Adding Revision Clouds

A revision cloud is used to indicate that certain areas of a drawing contain revisions. A revision cloud may include a date/time stamp. To create and use revision clouds:

1. Click on the top half of the **Annotations** button.
2. Or click on the bottom-half of the **Annotations** button, then **Revision Clouds**, and then **Revision Cloud** (Fig. 28-A).
3. Click on four **Points** defining the size of the cloud.
4. Press the **Esc** key or the **C** key to complete the cloud. Pressing **Ctrl + Z** will undo any **Point** placements.
5. Clicking on **Configure Revision Clouds** allows you to specify a time stamp and change other properties of the cloud.

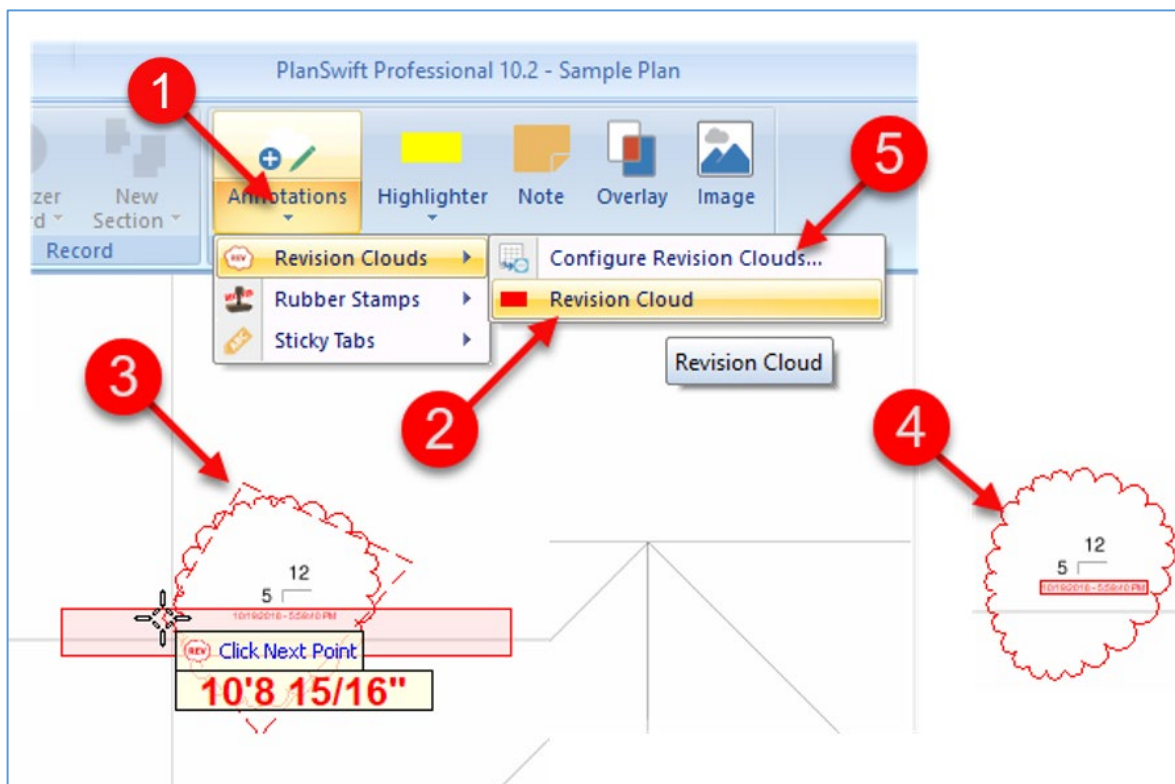

Figure 28-A

## Adding Rubber Stamps

Rubber stamps are a great way of indicating progress, approvals, updates, etc. PlanSwift provides several pre-formatted ones and permits the addition of a date/time stamp as well. You can also add new stamps and delete stamps. To create and use rubber stamps:

1. Click on the drop-down half of the **Annotations** button on the **Home** tab ribbon-bar and hover over the **Rubber Stamps** selection until its submenu appears (Fig. 28-B).
2. Click on the desired stamp.
3. Click on the page where you want the stamp to appear. Examples of default stamps are shown.
4. If you want to reconfigure any of the rubber stamps or add stamps of your own design, click on **Configure Rubber Stamps** selection, and a range of options are available.

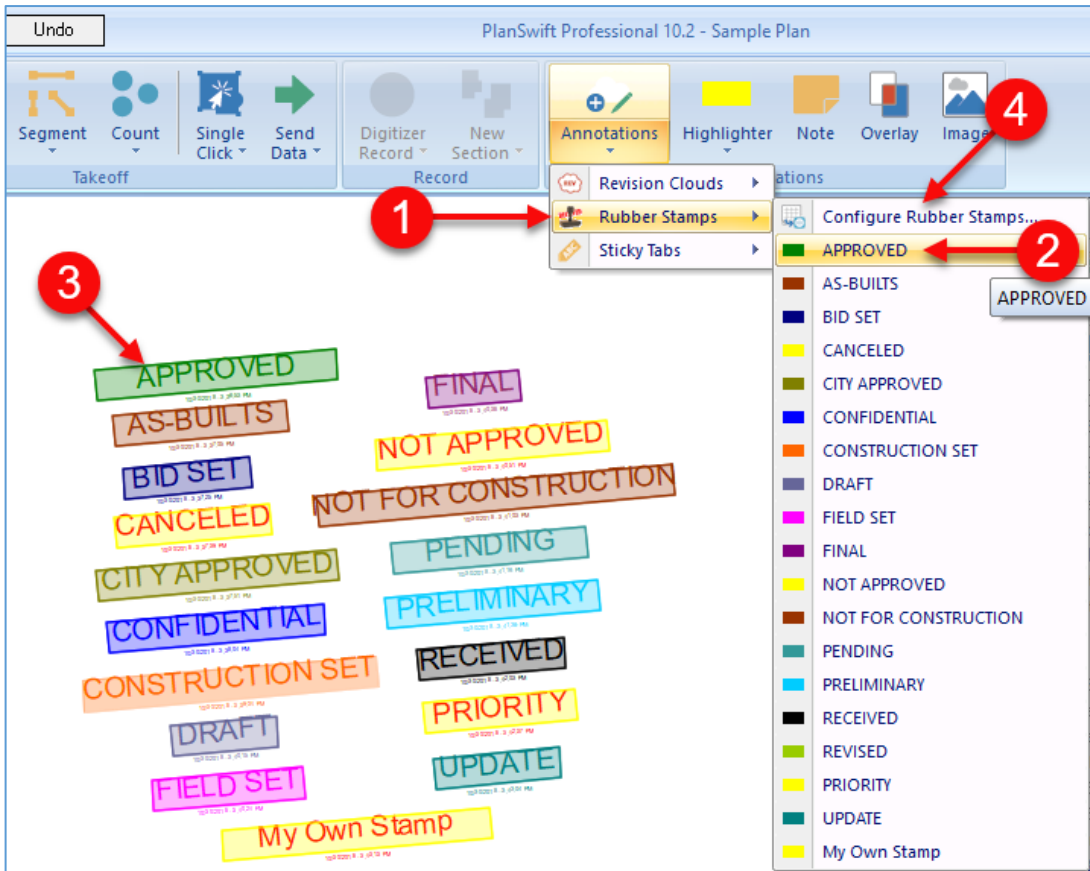

Figure 28-B



## Adding Sticky Tabs

Sticky tabs are arrows with labels and may also include a date/time stamp. You can choose from default ones or create your own and attach notes to them. To create and use sticky notes:

1. Click on the drop-down half of the **Annotations** button and click on **Sticky Tabs** (Fig. 28-C).
2. Click on the desired sticky tab.
3. Click and hold on the first **Point** where you want the sticky tab's arrow to point to.
4. **Drag** the cursor the length you want for the tab.
5. This is the **primary label**.
6. Sticky tabs can be created and configured by clicking on **Configure Sticky Tabs**.

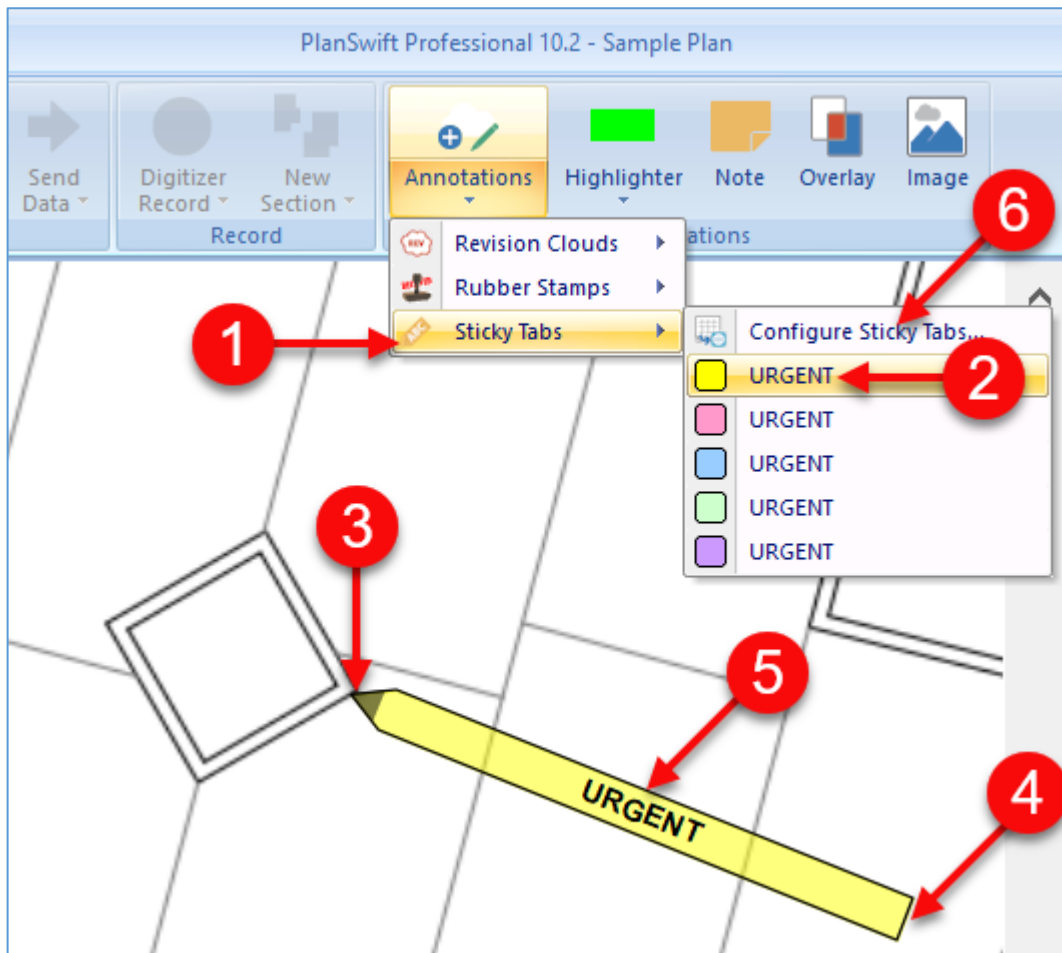

Figure 28-C

## Adding Highlights

Users can add highlights to pages with the **Highlighter** tool found on the **Home** tab ribbon-bar. Yellow is the default color. To highlight an area:

1. Click on the drop-down half of the **Highlighter** button to select a color for the highlighting (Fig. 28-D).
2. Click on the top half of the **Highlighter** button.
3. Click and hold the left mouse button and drag a box over the area to be highlighted.
4. Release the mouse button. Click and drag again to draw another highlighted area or press **Esc** to stop the highlighter tool.

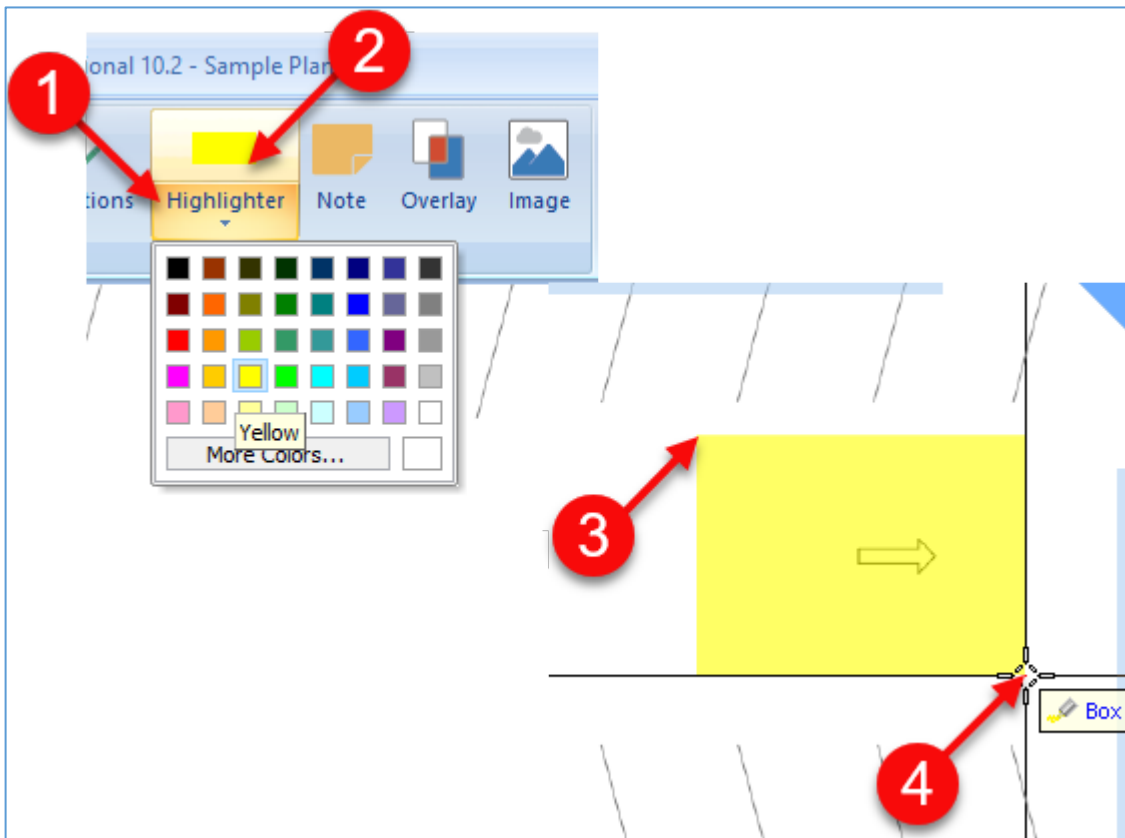

Figure 28-D

## Adding an Image to a Page

Users can add images to pages with the **Image** tool found on the **Home** tab ribbon-bar. To add an image:

1. Click on the **Image** button on the **Home** tab ribbon-bar (Fig. 28-E).
2. In the **Open** window, navigate to the image you want to place on the current page.
3. Click on the desired image so that its name shows in the **File name** field.
4. Click on **Open**, which will close the **Open** window.

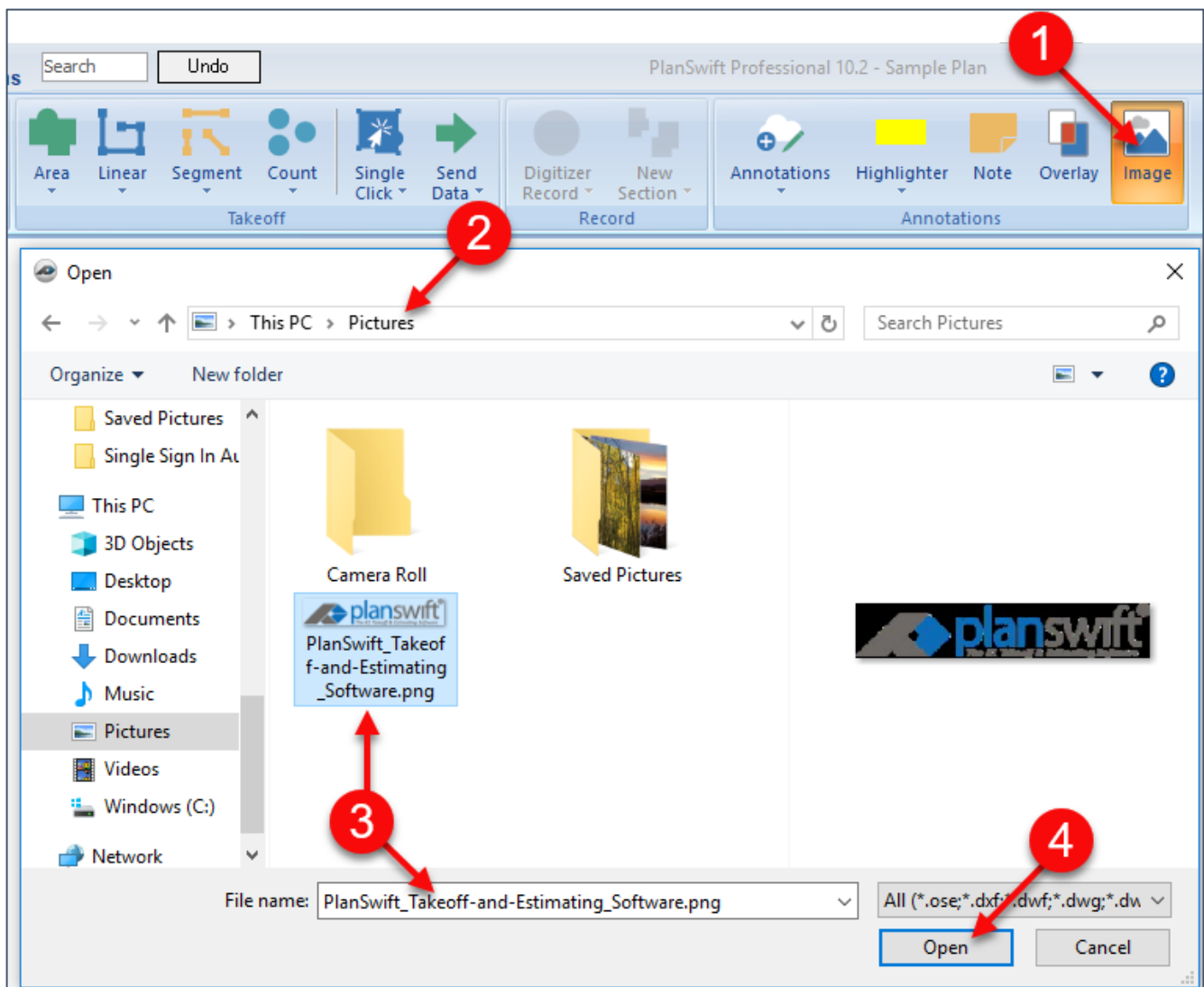

Figure 28-E

5. You are now prompted to click two **Points** for the placement of the image. You can then drag the **Points** to resize and place the image (Fig. 28-F). Images can also be copied, pasted, and locked in place using commands on the image's right-click menu.

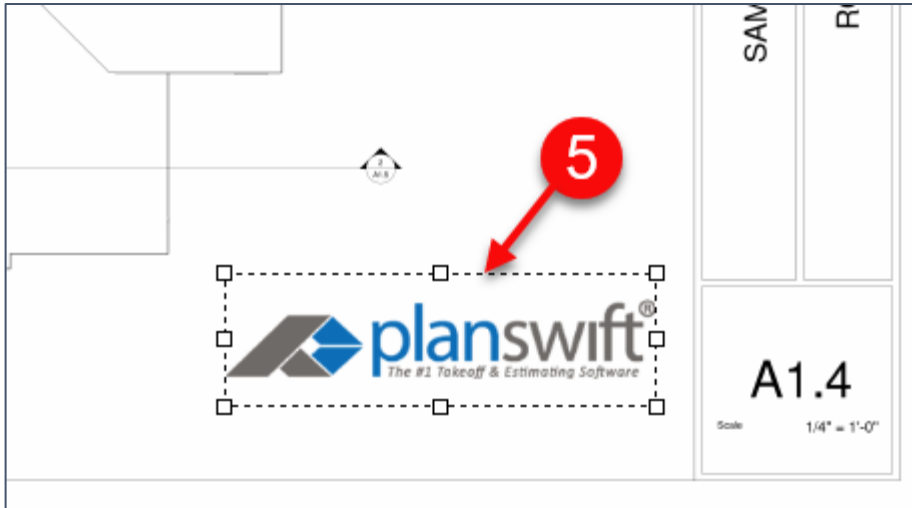

Figure 28-F

## Adding an Overlay of a Page

The **Overlay** tool allows you to place, or overlay, a separate page from your plans onto your current page. There are two types of overlays. The **Standard Overlay** type allows you to overlay a plan page on top of your current page, like a transparency, which is typically used for comparing multiple levels of the plan. The **Comparative Overlay** type allows you to compare two versions of the same page after a revision so that you can see additions and deletions. Additions are shown in red, deletions in blue. Both overlay types use the same procedure. To create a standard overlay:

1. With the page open that you want to overlay a page on top of, click on the **Overlay** button on the **Home** ribbon-bar tab (Fig. 29-A).
2. This opens the **Overlay Type** window.
3. Select **Standard Overlay**.
4. Click on **Next**.
5. This opens the **Select Overlay** window.
6. Type the name of the overlay into the **Name** field.

7. Click on the **Color** field's drop-down menu to select a color.
8. The available overlays are listed in the large window and can be clicked on to select one, or you can type the name of an overlay into the **Search** field.
9. After selecting an overlay, click on **Finish**.

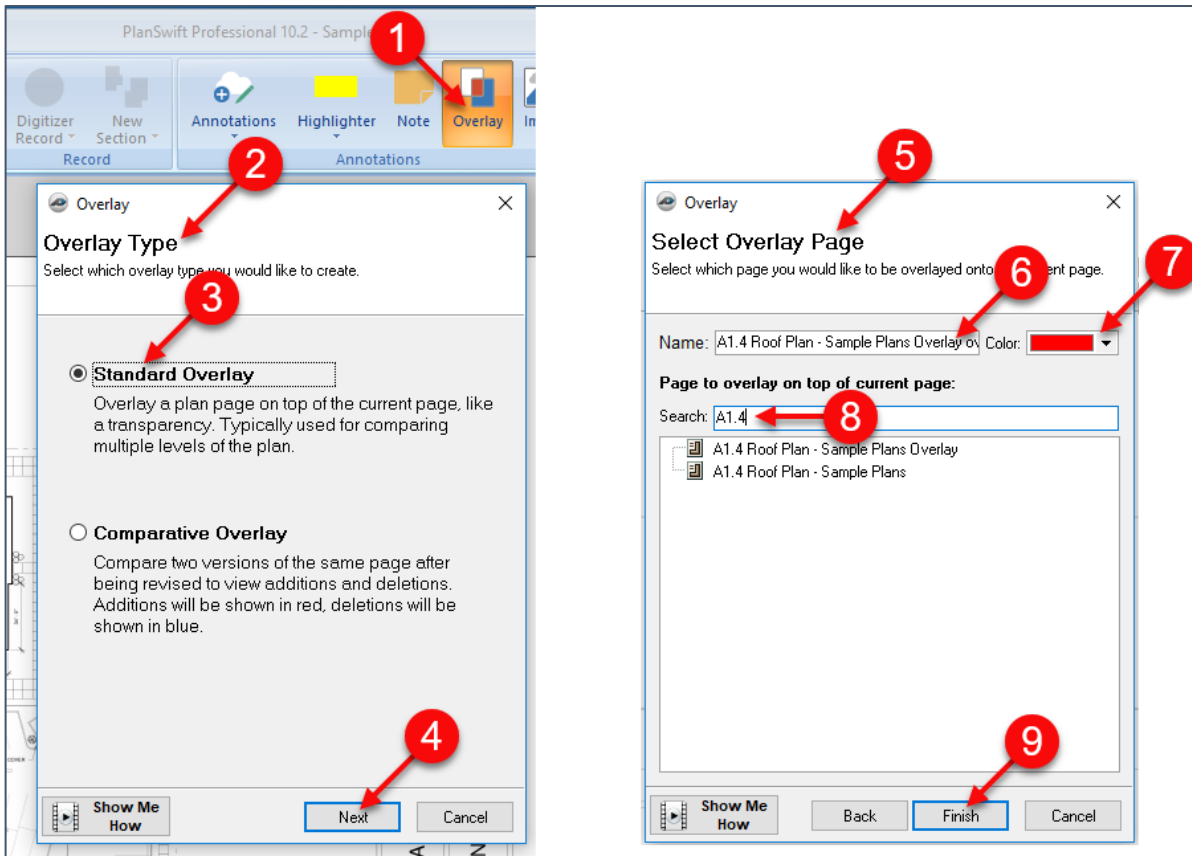

Figure 29-A

10. The overlay is now displayed.

11. A **Confirm** window asks if you want to align the overlay. Click on **Yes** (Fig. 29B).

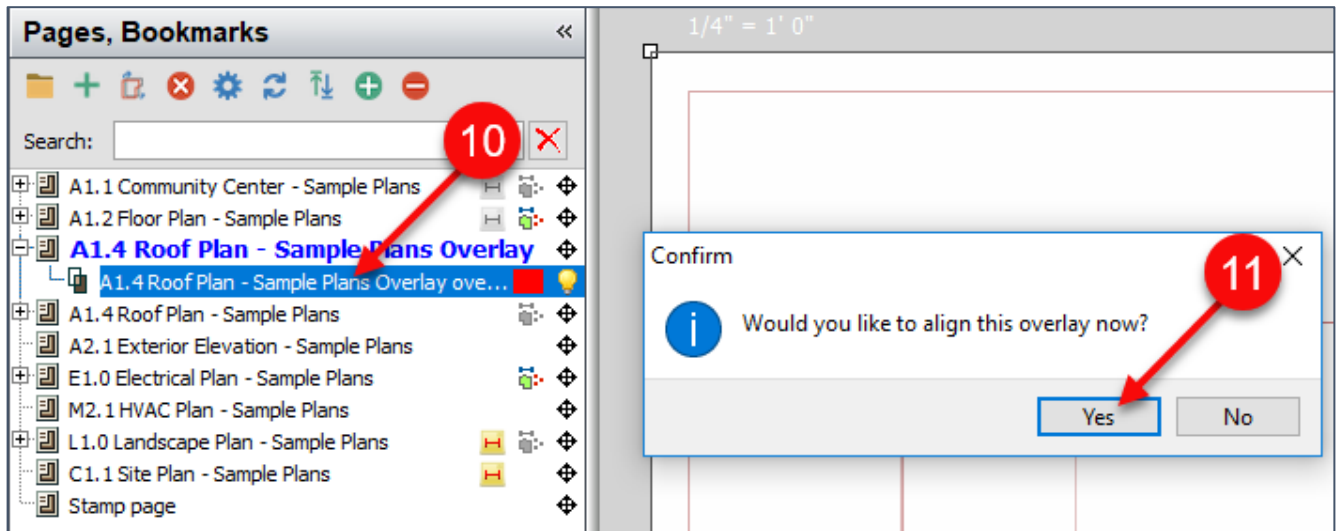

Figure 29-B

12. You are now prompted to click the first alignment **Point** on the overlay (Fig. 29-C).

13. Three more steps have you aligning the overlay, clicking the second **Point**, and aligning the second **Point** so that the overlay is exactly over the original plan.

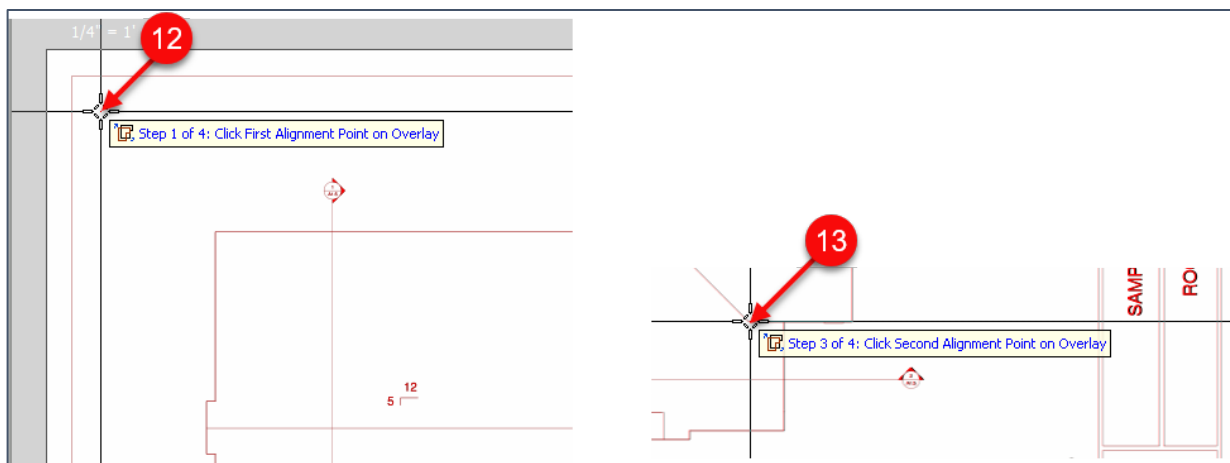

Figure 29-C

14. If you don't line it up correctly, hover over the new overlay in the **Pages, Bookmarks** window until the re-do button appears, then click on the button (Fig. 29-D) and start the four alignment steps over again. Note that you can [zoom](#) and [pan](#) as normal while performing the alignment steps.

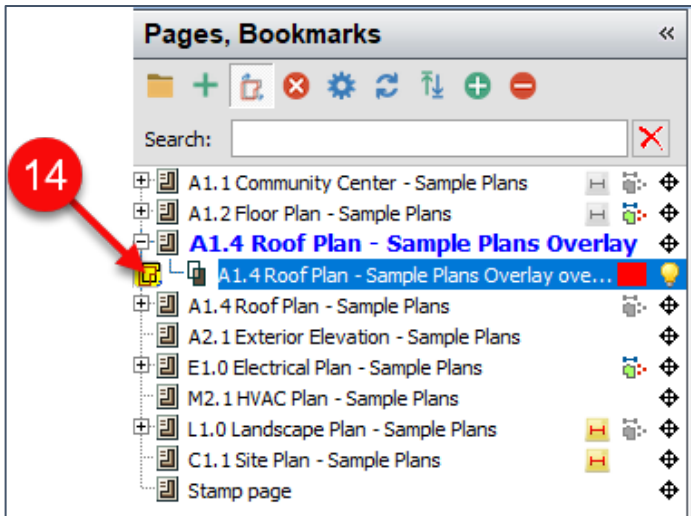

Figure 29-D

15. Figure 29-E shows a **comparative overlay** of a landscaping plan overlaying a site plan. Notice that plants are shown in red as additions, topography numbers are shown in blue as deletions, and the rest is shown in black as unchanged.

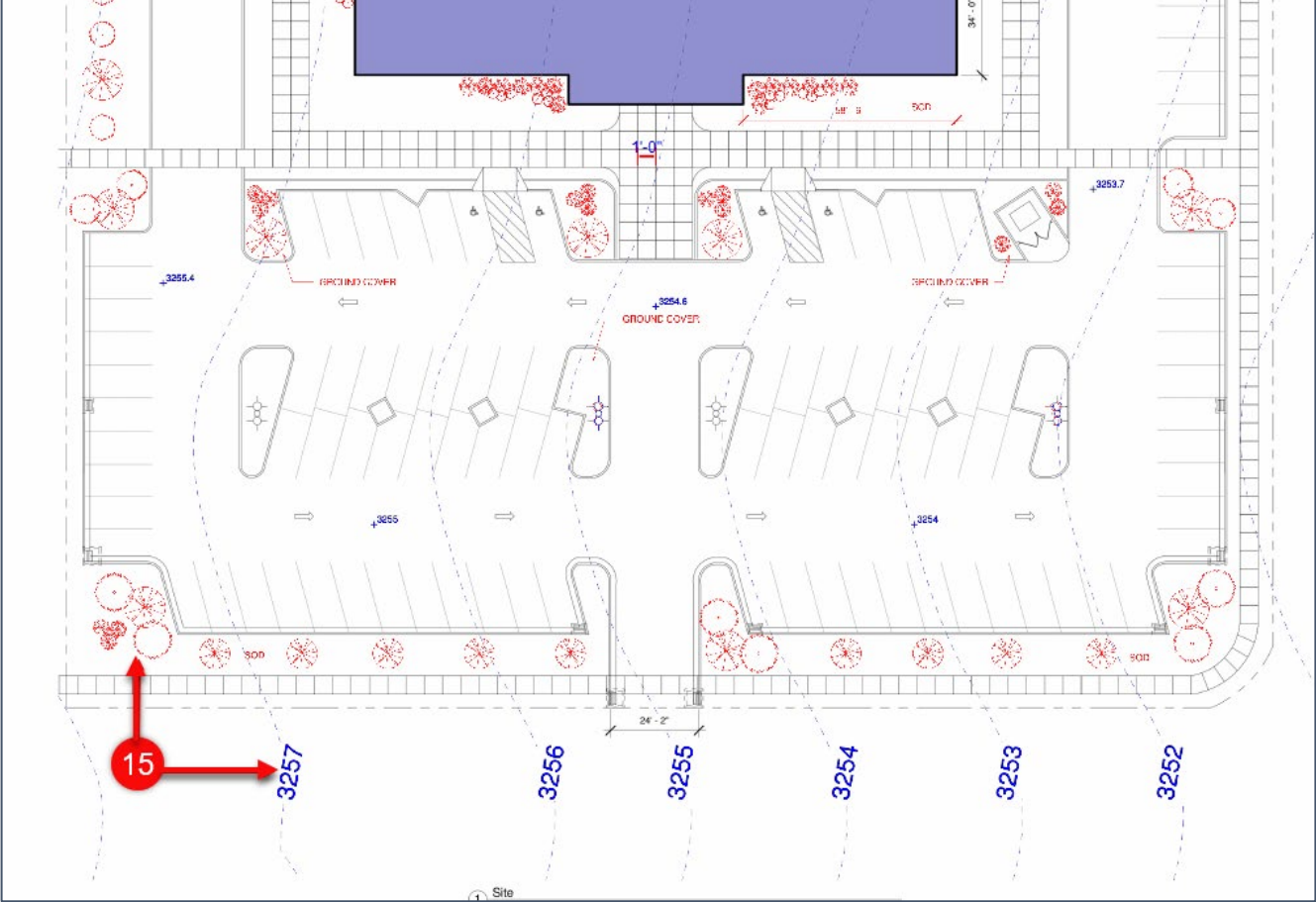

Figure 29-E



---

## Accessing Specialty Takeoff Items

PlanSwift provides specialty takeoff items that are available from the **Area**, **Linear**, **Segment**, and **Count** drop-down menus located on the **Home** tab ribbon-bar. These are the [Single Click Area](#), [Linear, and Count](#) takeoffs, the [Roof Area](#) takeoff, the [Price Per SQ FT Area](#) takeoff, the [Area Cubic Yards](#) takeoff, the [Grid Tool Area](#) takeoff, and the [Joist Tool Area](#) takeoff.

### Single-Click Area Takeoff

Single-click area takeoffs are another means to perform an area takeoff and can be faster to perform than conventional takeoffs. Single-click area takeoffs utilize the digital lines on plan pages as well as user-inserted “cut-lines” to restrict the area size to the desired area. Single-click area takeoffs also only measure areas *inside* of the plan lines, so if an area you are measuring needs to include, say, the area under a four-inch wide wall, then you may be better off using the standard area takeoff tool. To perform a single-click area takeoff:

1. Click on the **Single Click** button on the **Home** tab ribbon-bar menu (Fig. 30-A).
2. Select **CutLine** from the drop-down menu.
3. The right-side door will need a cutline to contain the area takeoff inside the room. Click on the two **Points** indicated for the beginning and end of the cutline (longer cut-lines are more effective than shorter cut-lines).

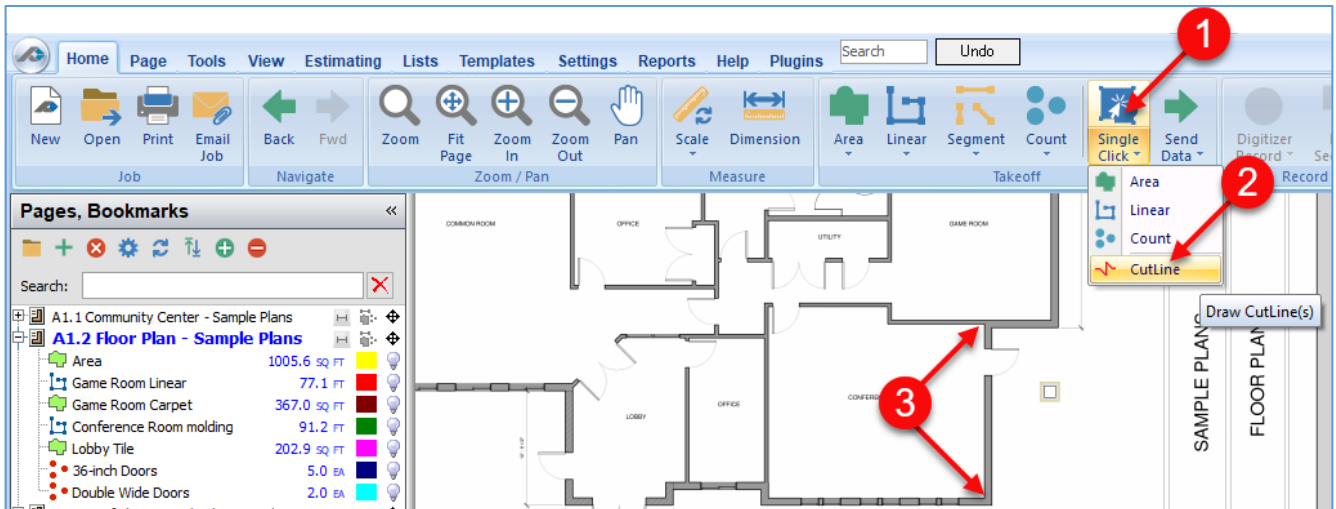

Figure 30-A

4. A red cut-line appears (Fig. 30-B).
5. Click on the **Single Click** button again and select **Area** from the drop-down menu.
6. In the **Properties - [Area]** window, enter the **Name** for the takeoff.
7. Select a color.
8. Select a fill.
9. Select a folder if desired.
10. Click on **Ok**.
11. Click in the area where you want the one-click takeoff.

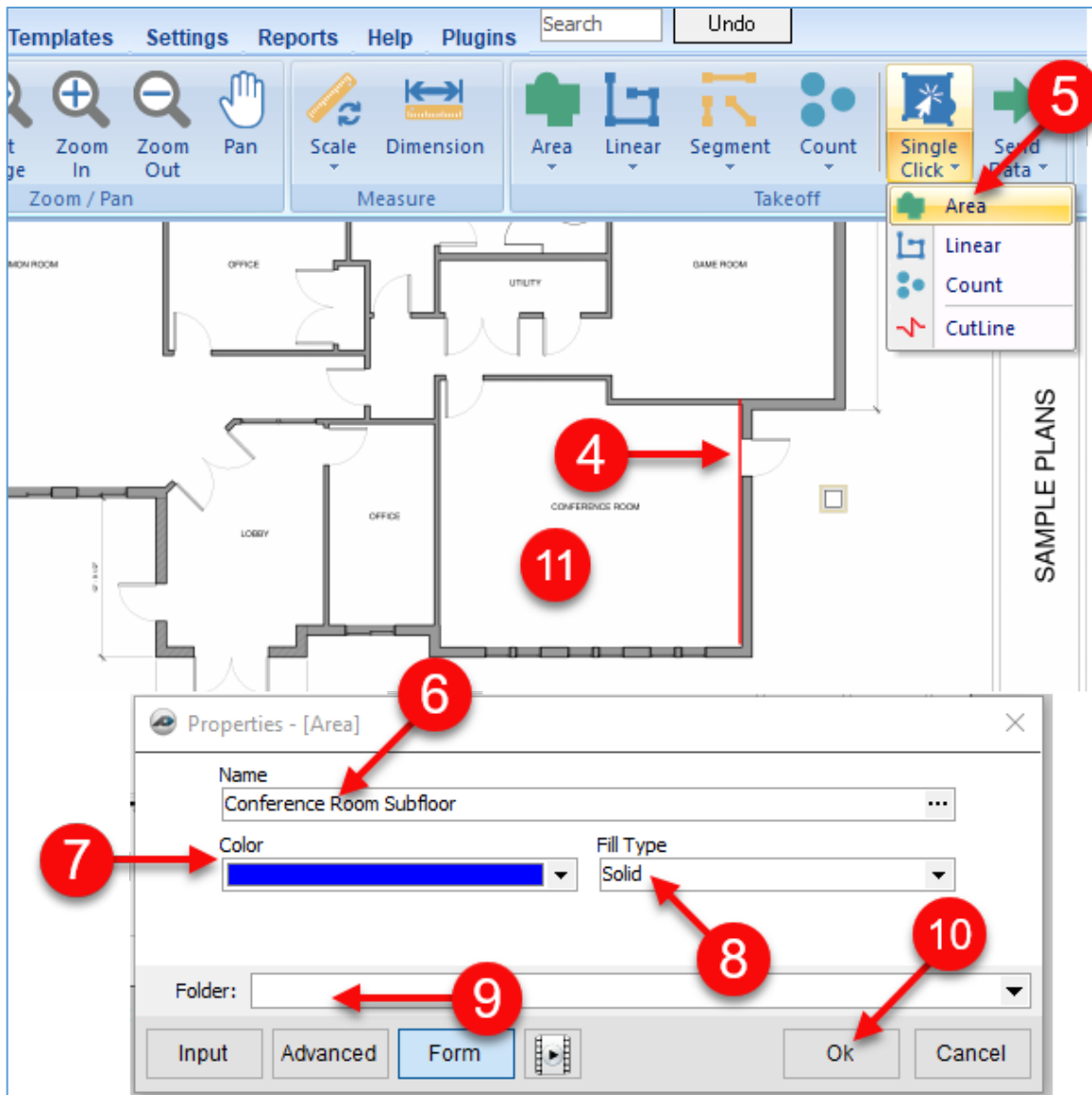

Figure 30-B

12. An array of one-click icons now fills the area (Fig. 30-C). If you have more than one area to include, click those areas next. Each time you click a new area, the fill will be placed in the previous area.
13. After you have selected the area(s) you want, press **Esc** to fill in the final area you clicked on.
14. Note that the top-left door line arc stopped the area takeoff from filling the area behind the arc of the door.
15. To fill this area, click on the takeoff, zoom in on it, and drag the cursor to select the area shown.
16. Upon selection, the selected **Points** become highlighted in green.
17. Press **Del** to delete the green-highlighted **Points**.

18. The takeoff now reflects the actual shape of the room area.

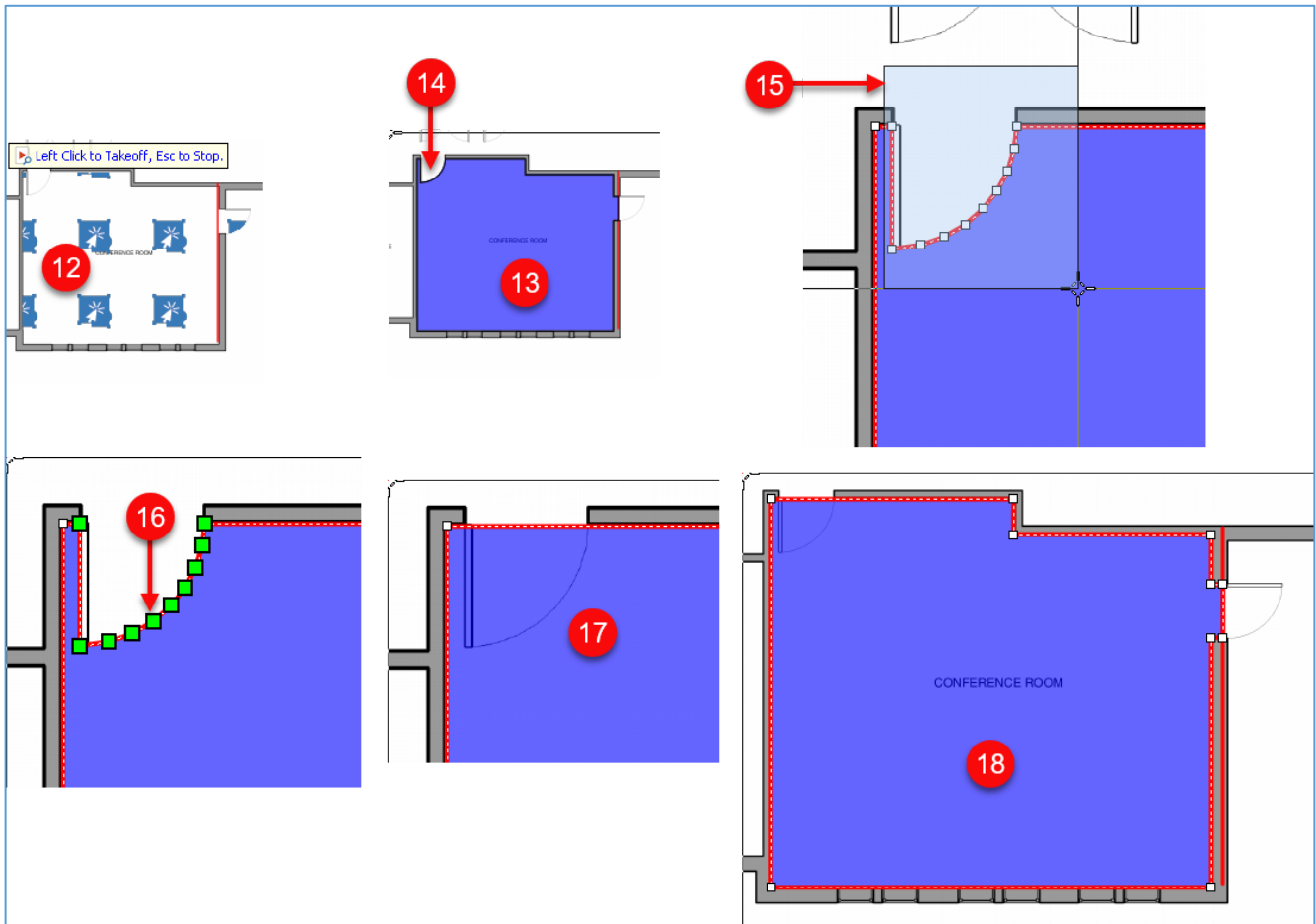

Figure 30-C

## Single-Click Linear and Count Takeoffs

Single-click linear and count takeoffs work identically to the [single-click area](#) takeoffs.

To perform a single-click linear or a single-click count takeoff:

1. Click on the drop-down half of the **Single Click** button and select **Linear** (or **Count**) from the drop-down menu (Fig. 31-A), then follow the steps for a [single-click area](#) takeoff.

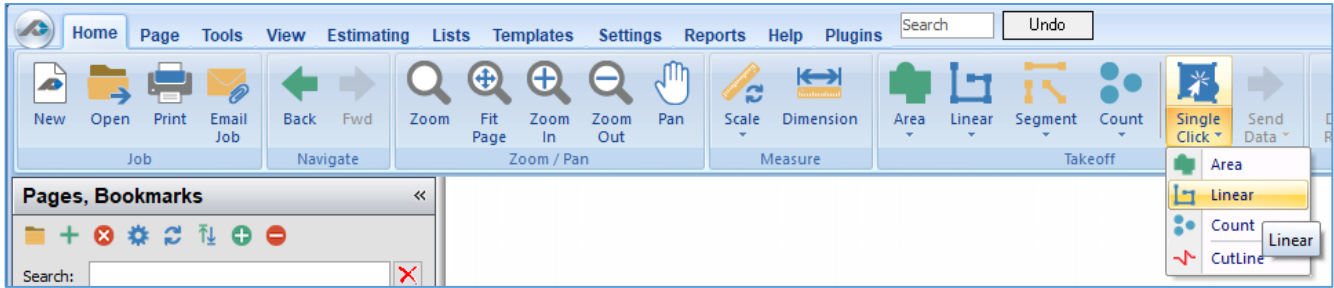

Figure 31-A

## Roof Area Takeoff

Performing a **Roof Area** takeoff requires familiarity with performing an [area](#) takeoff. Roof area takeoffs differ from other area takeoffs because roofs also have a pitch component. To perform a roof area takeoff:

1. Click on the drop-down half of the **Area** button (on the **Home** tab ribbon-bar) and select **Roof Area** from the drop-down menu (Fig. 32-A).
2. In the **Properties – [Roof Area]** window, enter the name of the takeoff into the **Name** field.
3. Enter the pitch (5) in the **Pitch** field.
4. Select the color of the takeoff.
5. Select the **Fill Type**.
6. Enter a folder name if desired.
7. Click on **Ok**.

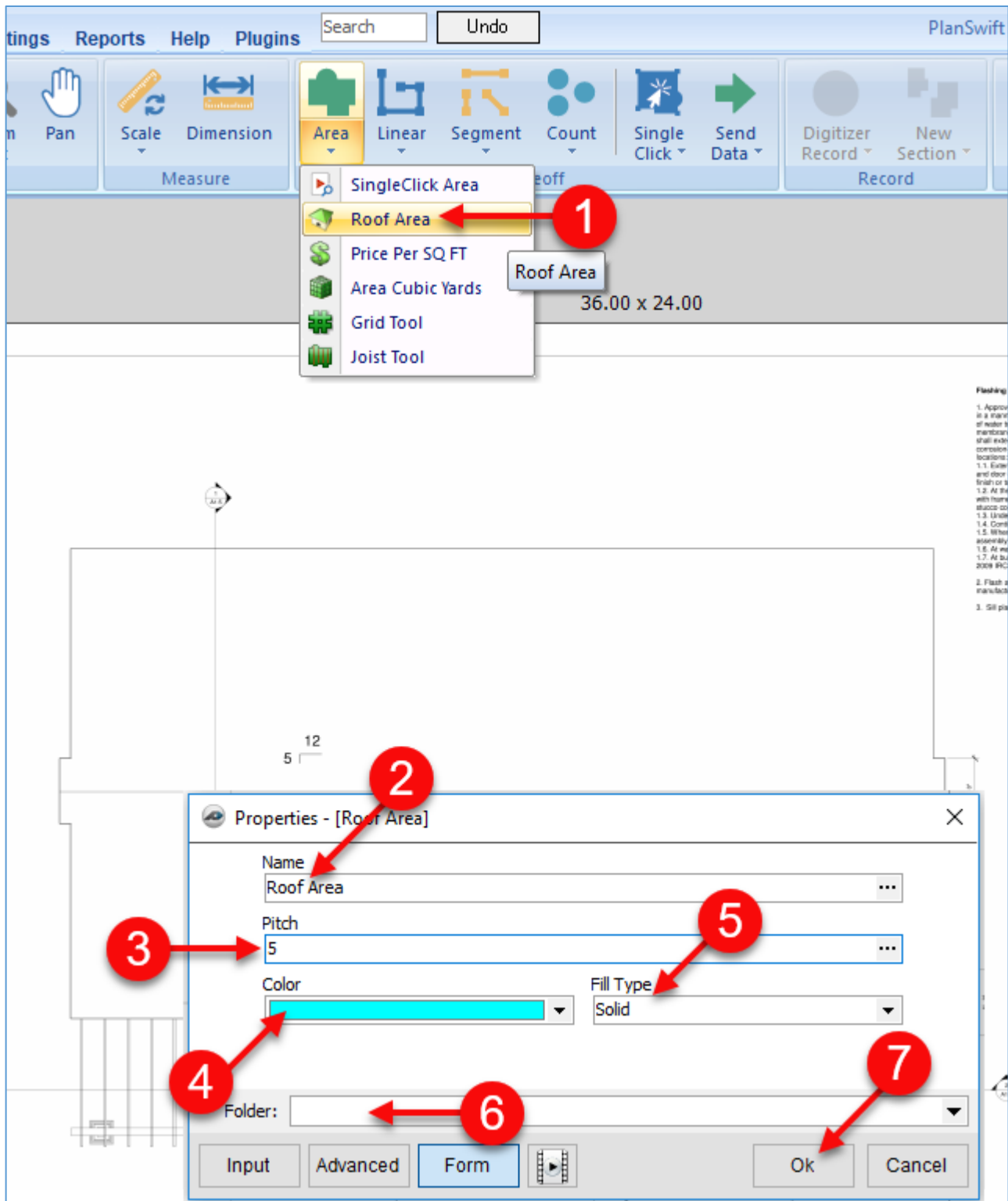

Figure 32-A

8. The **Digitizer Record** turns on (Fig. 32-B).
9. Perform the takeoff as you would an [area](#) takeoff. For more accuracy, use the **M** (hotkey) to magnify each corner
10. Click on **Point 10**.
11. Click on **Point 11**.
12. Click on **Point 12**.

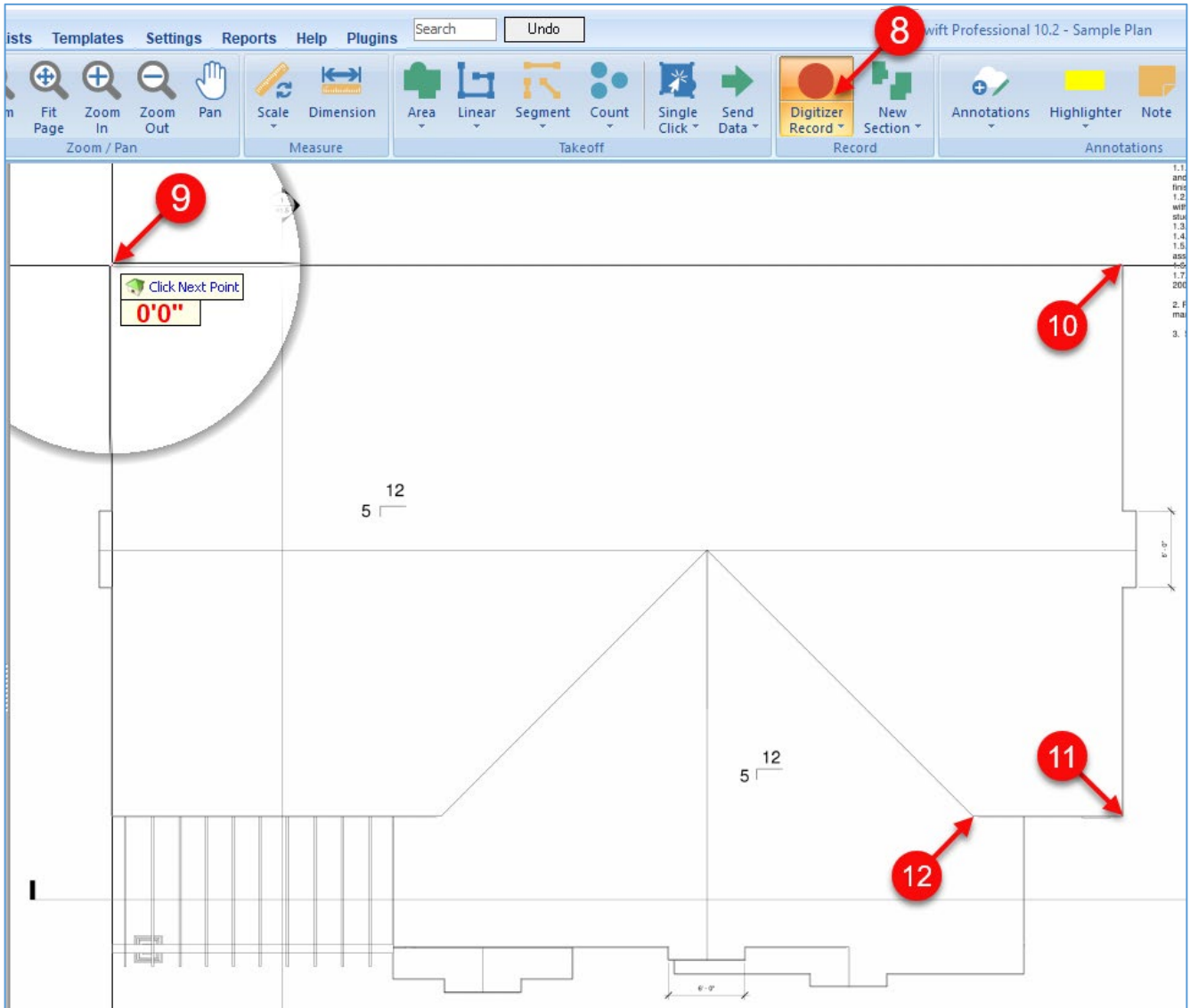

Figure 32-B

13. As you click on each of the corners, the fill you chose is displayed up to the **Point** of your latest click. Click on the fifth **Point** (Fig. 32-C).
14. Click on the sixth **Point**.
15. Click on the seventh **Point**.
16. Right-click on the seventh **Point** and select **Stop** from the drop-down menu. This completes the roof takeoff, except for the front section. If you want to include the front section, then instead of clicking on stop, click on **New Section** on the drop-down menu and continue to perform the takeoff of the front section in the same manner.

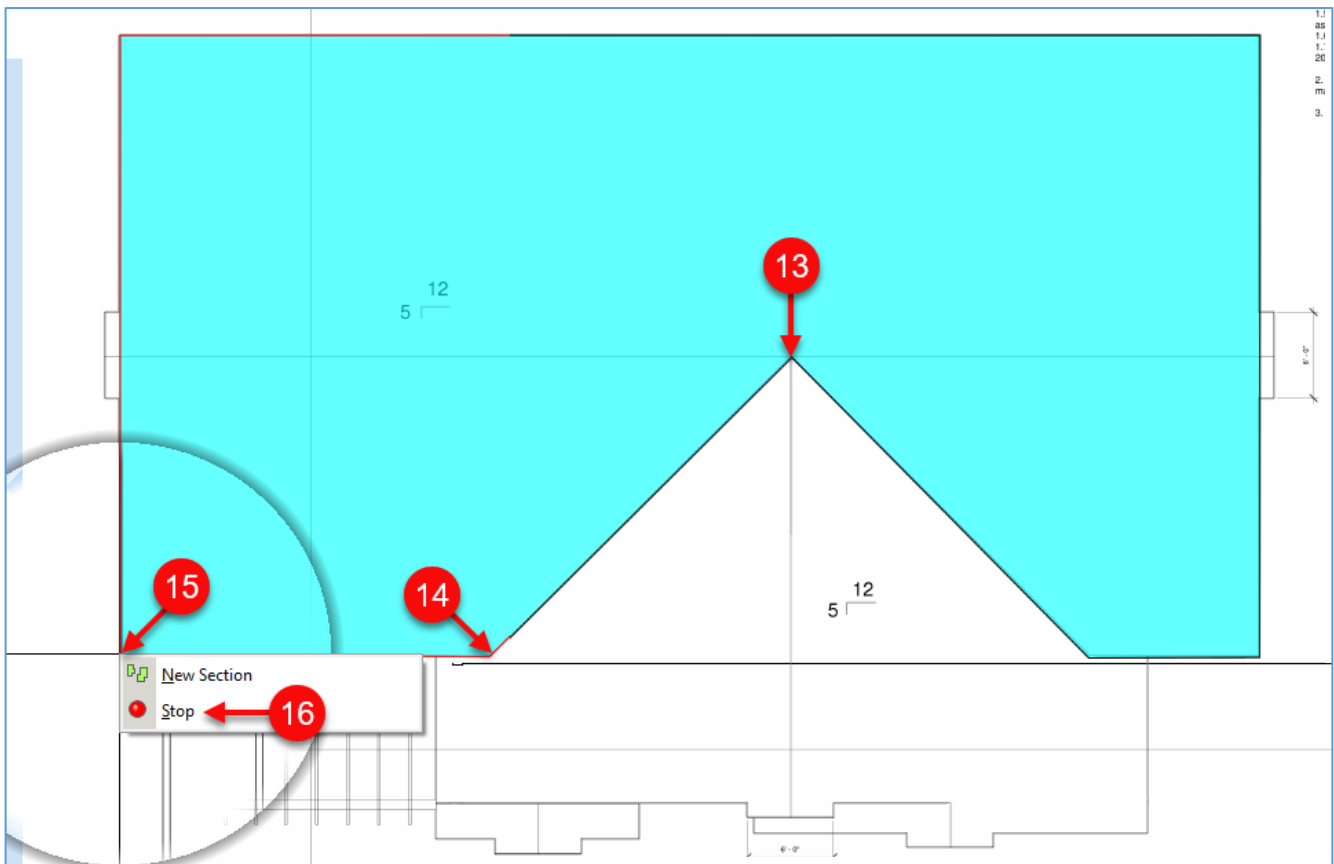

Figure 32-C



## Price Per SQ FT Area Takeoff

Performing a **Price Per SQ FT Area** takeoff requires familiarity with performing an [area](#) takeoff. PlanSwift makes it easy to figure out the price per square foot for areas. To perform a price per square foot takeoff:

1. Click on the drop-down half of the **Area** button and select **Price Per SQ FT** from the drop-down menu (Fig 33-A).
2. In the **Properties – [Price Per SQ FT]** window, enter the name of the takeoff into the **Name** field.
3. Enter the price in the **Price Per SQ FT** field.
4. Select the color of the takeoff.
5. Select the **Fill Type** and enter a folder name if desired.
6. Click on **Ok**.

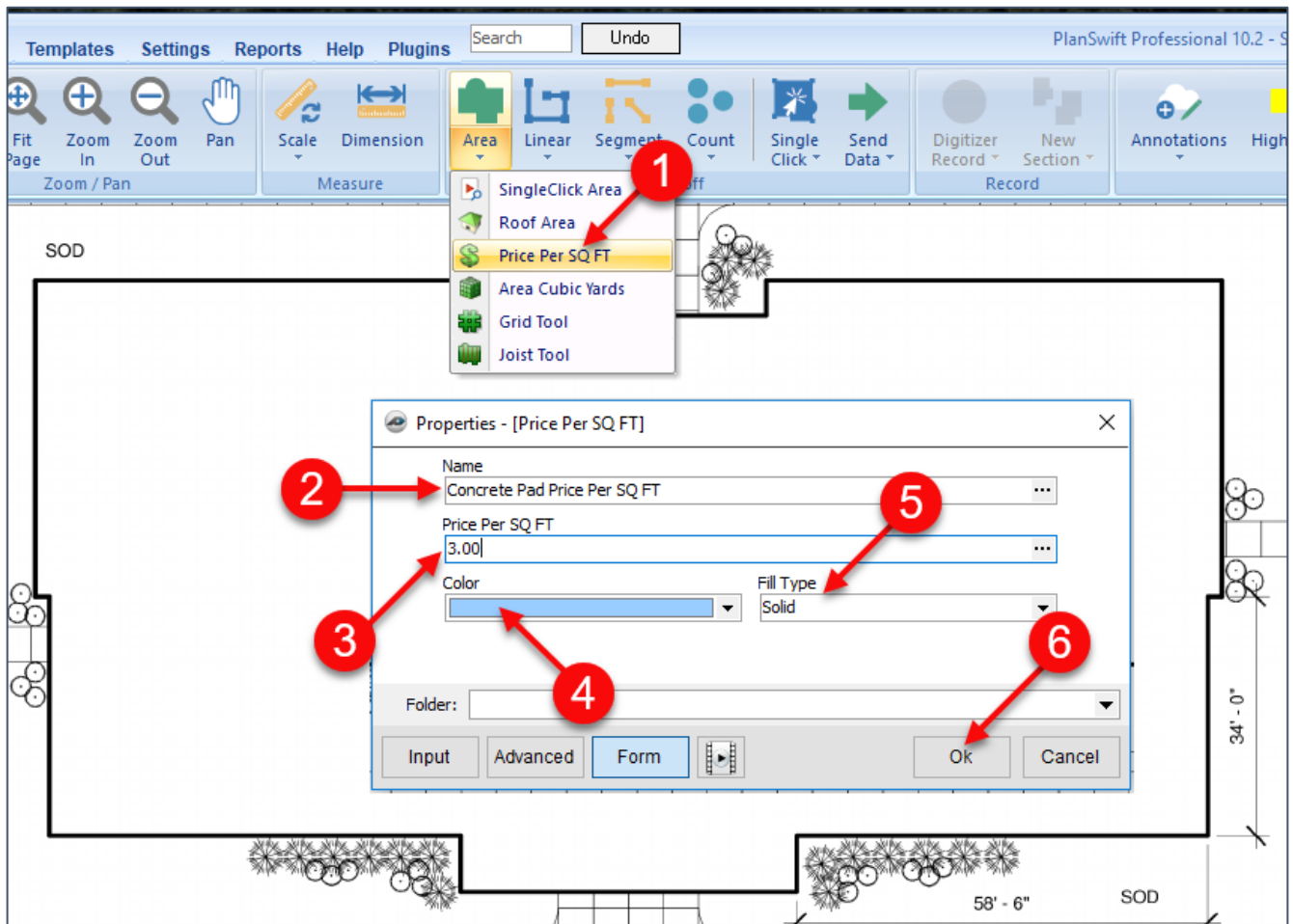

Figure 33-A

7. The **Digitizer Record** is now turned on. Perform the takeoff by clicking on all corners (inside and outside) of the concrete pad (Fig. 33-B).
8. With the digitizing done, right click on the last **Point** and select **Stop** from the drop-down menu.

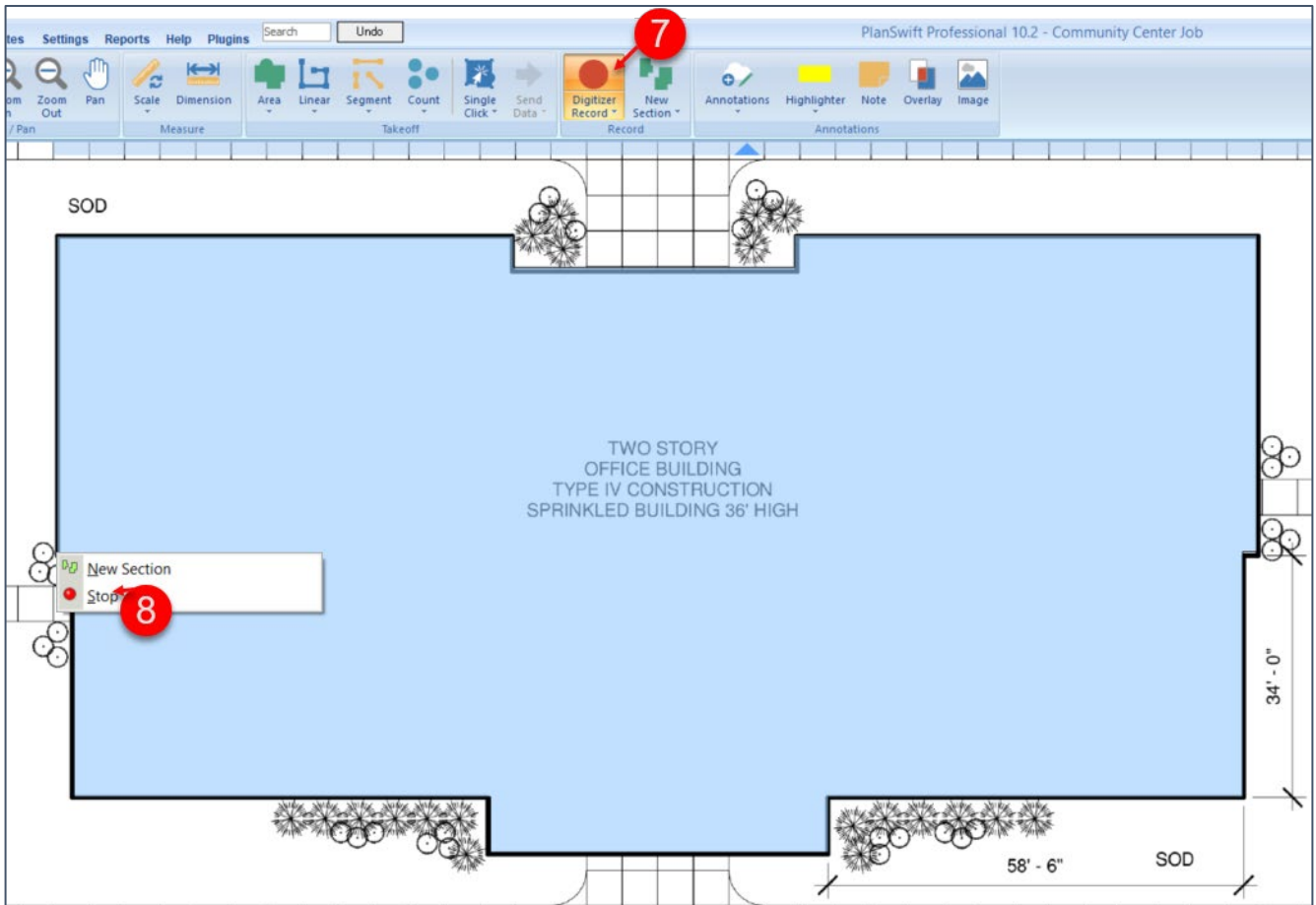

Figure 33-B

9. The square footage of the pad shows as 13,529.6 SQ FT in the **Pages, Bookmarks** window (Fig. 33-C).
10. Click on the **Estimating** tab on the **Home** tab of the **Main** ribbon-bar menu.

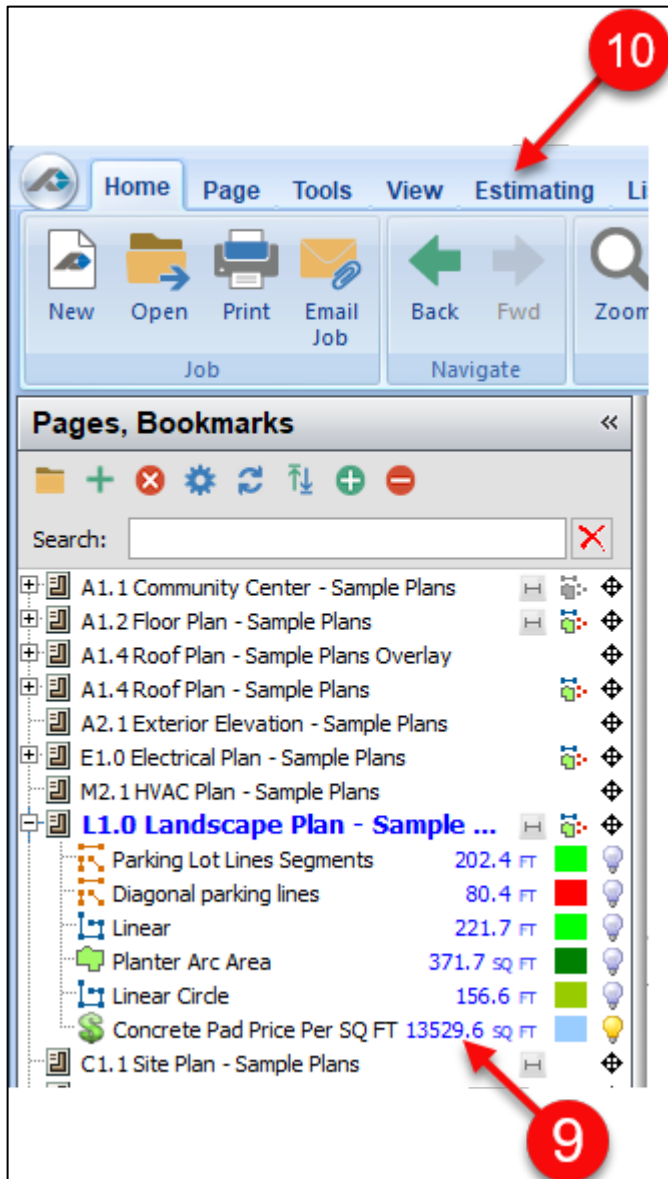

Figure 33-C

11. Note that the **Cost Total** of the pad is \$40,588.89 in the **Estimating** window.

Name	Description	Qty	Units	Cost Each	Cost Total	Markup %	Price Each	Price Total	Color
CAT 5		21.77	FT	\$0.00	0.00	0	\$0.00	\$0.00	
Area		0	SQ FT	\$0.00	0.00	0	\$0.00	\$0.00	
Area		1005.57	SQ FT	\$0.00	0.00	0	\$0.00	\$0.00	
Game Room Linear		77.13	FT	\$0.00	0.00	0	\$0.00	\$0.00	
Parking Lot Lines Segments		202.39	FT	\$0.00	0.00	0	\$0.00	\$0.00	
Diagonal parking lines		80.39	FT	\$0.00	0.00	0	\$0.00	\$0.00	
Linear		221.65	FT	\$0.00	0.00	0	\$0.00	\$0.00	
Green Diagonals		0	FT	\$0.00	0.00	0	\$0.00	\$0.00	
Circuit Wire		22.73	FT	\$0.00	0.00	0	\$0.00	\$0.00	
Linear		0	FT	\$0.00	0.00	0	\$0.00	\$0.00	
Planter Arc Area		371.74	SQ FT	\$0.00	0.00	0	\$0.00	\$0.00	
Linear Circle		0	FT	\$0.00	0.00	0	\$0.00	\$0.00	
Linear Circle		0	FT	\$0.00	0.00	0	\$0.00	\$0.00	
Linear		0	FT	\$0.00	0.00	0	\$0.00	\$0.00	
Linear Circle		156.57	FT	\$0.00	0.00	0	\$0.00	\$0.00	
Game Room Carpet		367.02	SQ FT	\$0.00	0.00	0	\$0.00	\$0.00	
Conference Room molding		91.2	FT	\$0.00	0.00	0	\$0.00	\$0.00	
Lobby Tile		202.87	SQ FT	\$0.00	0.00	0	\$0.00	\$0.00	
36-inch Doors		5	EA	\$0.00	0.00	0	\$0.00	\$0.00	
Double Wide Doors		2	EA	\$0.00	0.00	0	\$0.00	\$0.00	
Conference Room Subfloor		0	SQ FT	\$0.00	0.00	0	\$0.00	\$0.00	
Conference Room Subfloor		0	SQ FT	\$0.00	0.00	0	\$0.00	\$0.00	
Conference Room Subfloor		493.86	SQ FT	\$0.00	0.00	0	\$0.00	\$0.00	
Roof Area		3261.03	SQ FT	\$0.00	0.00	0	\$0.00	\$0.00	
Concrete Pad Price Per SQ FT		0	SQ FT	\$3.00	0.00	0	\$3.00	\$0.00	
Concrete Pad Price Per SQ FT		13529.63	SQ FT	\$3.00	40588.89	0	\$3.00	\$40588.89	

Summary: \$747.20      MAX=20.0%      \$43523.98

Figure 33-D

## Area Cubic Yards Takeoff

Performing an **Area Cubic Yards** takeoff requires familiarity with performing an [area](#) takeoff. PlanSwift makes it easy to figure out cubic yards calculations using area takeoffs. To perform an area cubic yards takeoff:

1. Click on the drop-down half of the **Area** button and select **Area Cubic Yards** (Fig 34-A).
2. In the **Properties – [Area Cubic Yards]** window, enter the name of the takeoff into the **Name** field.
3. Enter price per cubic yard into the **Price Per CU YD** field.
4. Enter the depth of the pad in inches into the **Depth (Inches)** field.
5. Select the color of the takeoff.
6. Select the **Fill Type** and enter a folder name if desired.
7. Click on **Ok**.

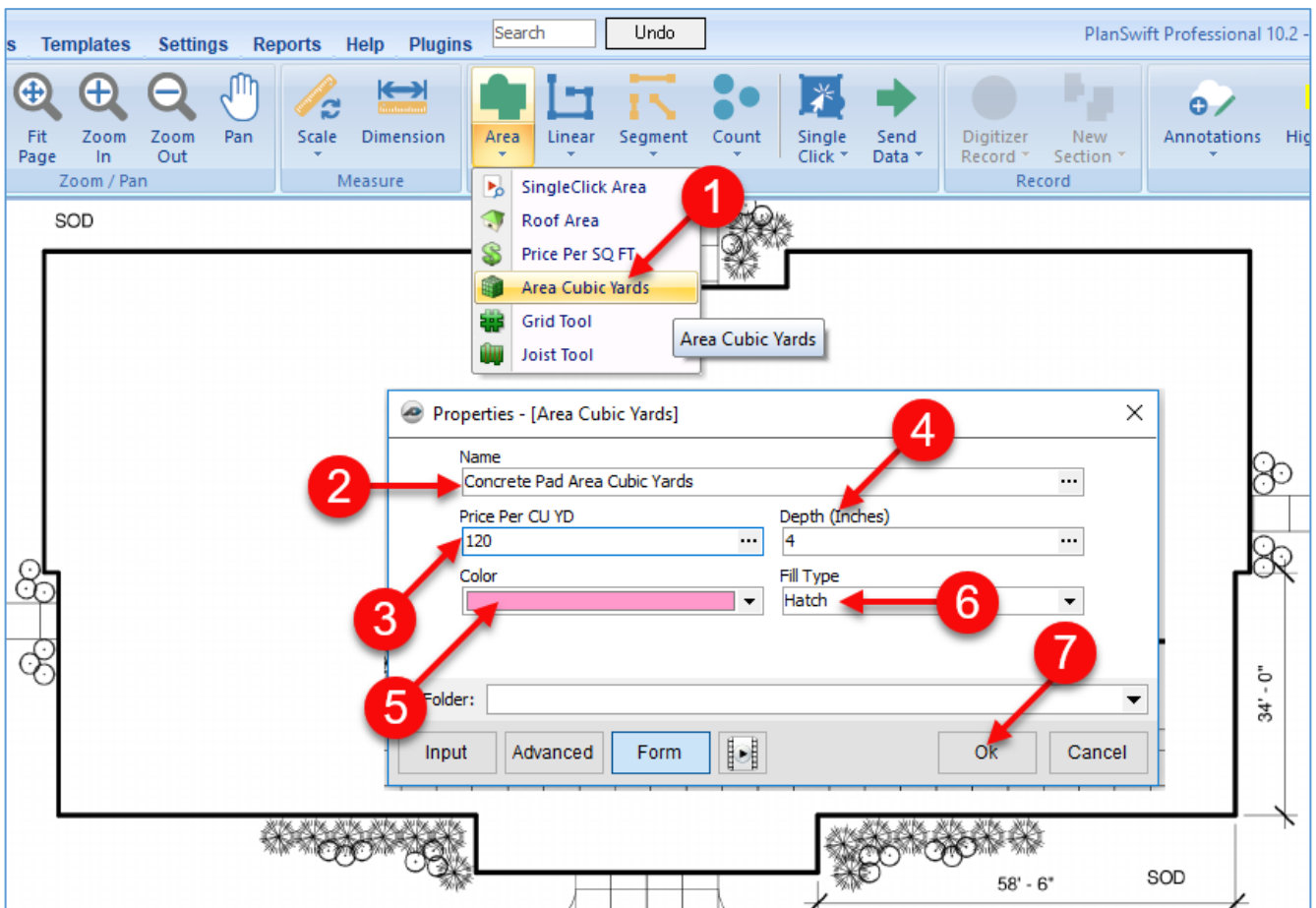

Figure 34-A

8. The **Digitizer Record** is now turned on. Perform the takeoff by clicking on all corners (inside and outside) of the concrete pad (Fig. 34-B).
9. With the digitizing done, right-click on the last **Point** and select **Stop** from the drop-down menu.

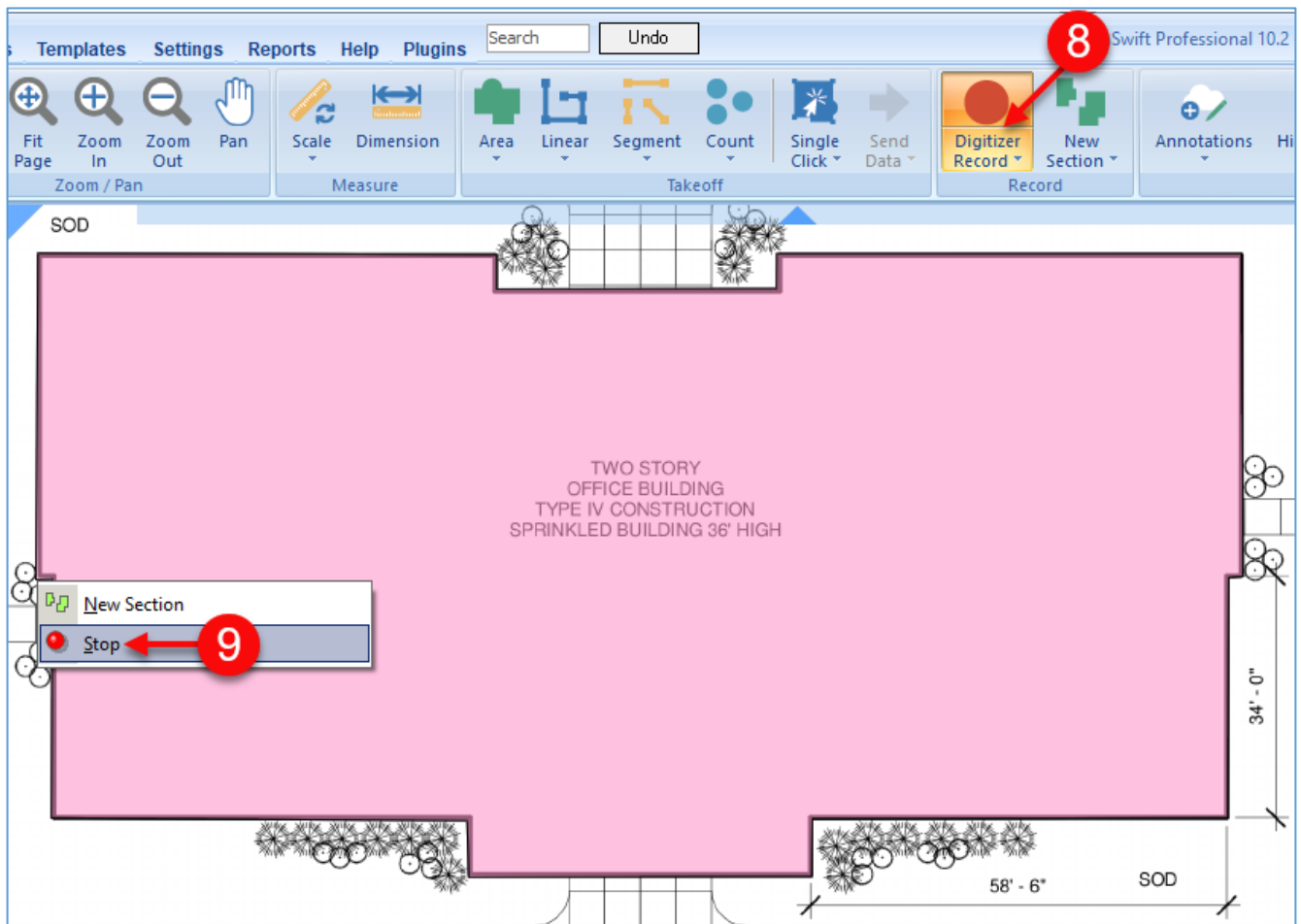

Figure 34-B

10. The total cubic yards of concrete (166.8 cubic yards) is displayed in the **Pages, Bookmarks** window (Fig. 34-C).

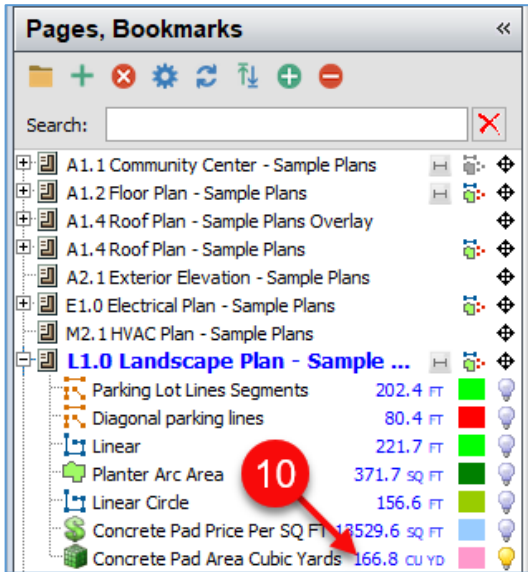

Figure 34-C

11. The cost total for the concrete is also calculated as well (Fig. 34-D).

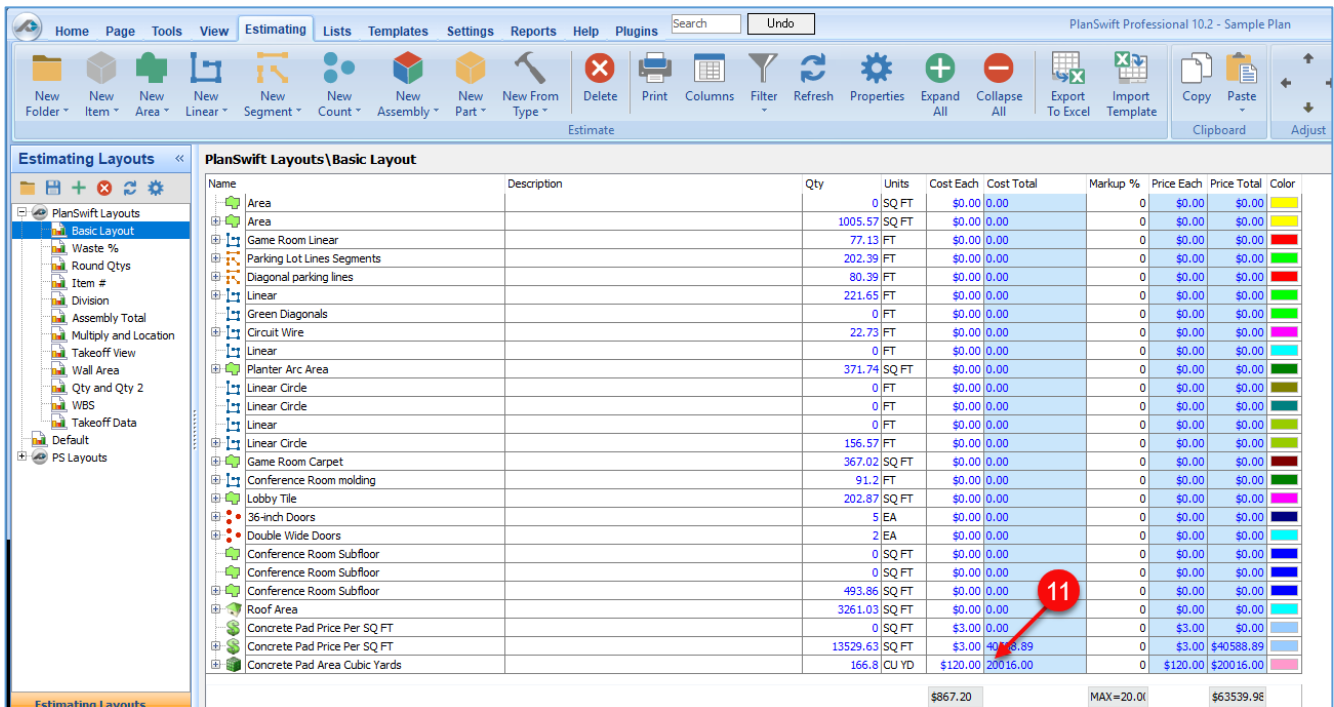

Figure 34-D

---

## Grid Tool Area Takeoff

Performing a **Grid Tool Area** takeoff requires familiarity with performing an [area](#) takeoff. The **Grid Tool Area** takeoff is useful for automatically calculating a grid on top of an area; from that calculated grid, you can determine quantities of rebar, tile, T-bar (or dropped) ceilings, or other similar items. To perform a grid tool area takeoff:

1. Click on the drop-down half of the **Area** button and select **Grid Tool** from the drop-down menu (Fig. 35-A).
2. This opens the **Properties – [Grid Tool]** window.
3. Enter a name for the grid takeoff.
4. To generate the grid automatically, click on the **Automatically Generate** checkbox.
5. Select the color of the takeoff.
6. Select a **Fill Type: Solid, Hatch Pattern, or Texture**.
7. Select the angle for the rebar (0 is vertical, 90 is horizontal, or anything in-between). This value will be ignored if the **Select Parallel Side** checkbox is checked.
8. Select the vertical spacing (by default in inches).
9. Select the horizontal spacing (by default in inches).
10. If you click on the **Select Parallel Side** checkbox, then any angle value entered in the **Angle** field will be ignored, and the software will prompt you to draw a line that the rebar should be parallel to.
11. Click on **Select Start Point** if you want to be prompted to click where you want the starting **Point** to begin.
12. Click on **Count Intersections** if you want the intersections to be counted; this could be useful to count the number of rebar high chairs needed.
13. Click on **Ok**.



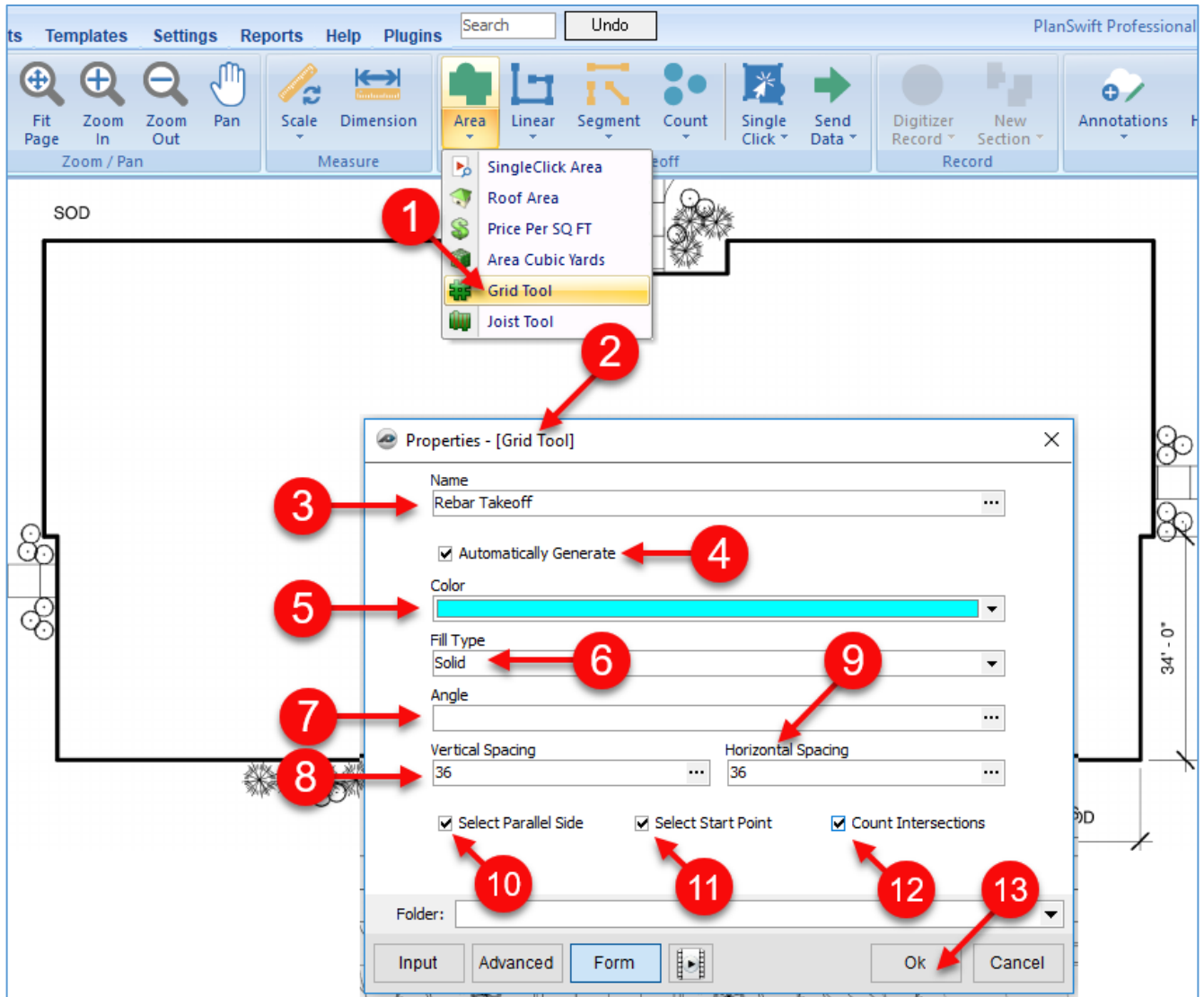

Figure 35-A

1. Perform the steps to do an [area](#) takeoff, then right-click and select **Stop** (Fig. 35-B).
2. Click on the first **Point** to select a parallel line.
3. Click on the second **Point** to select a parallel line.
4. Click on the start **Point** location.

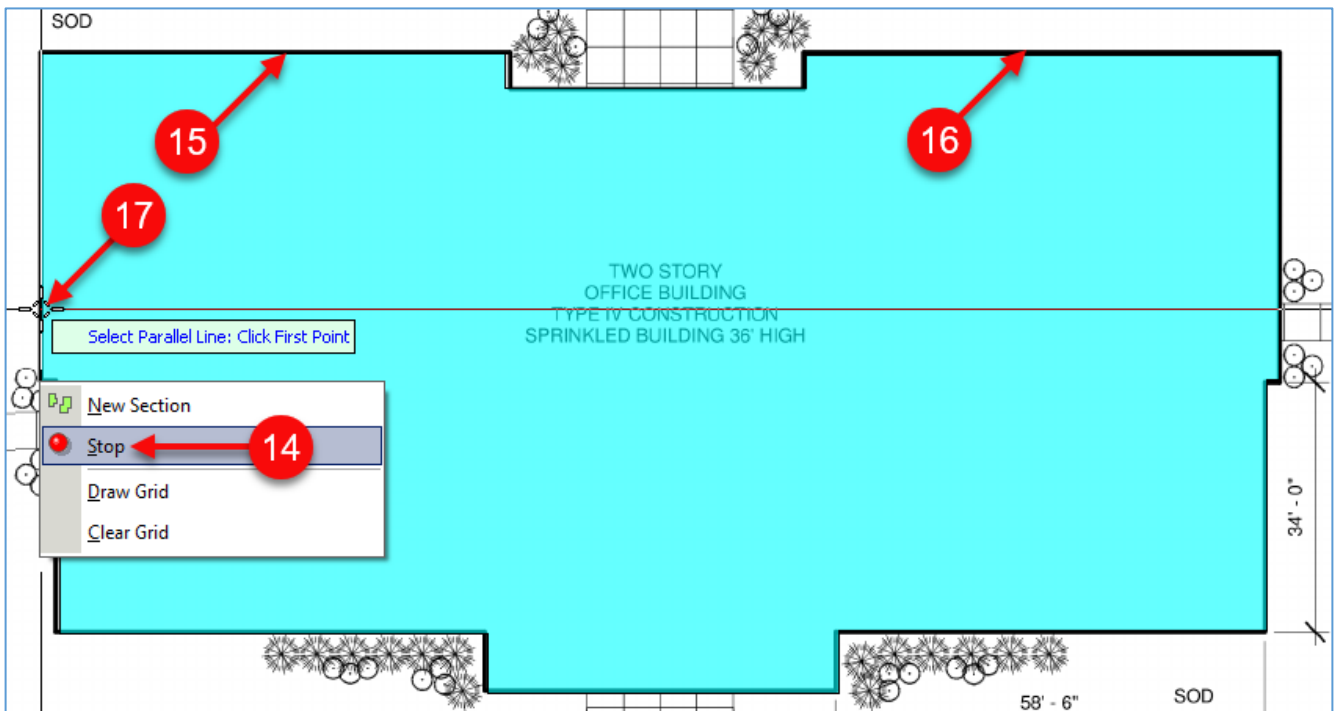

Figure 35-B

5. The grid now appears beginning at the start **Point** (Fig. 35-C).
6. Hovering the cursor over the diagram shows the area's square foot reading (535.4 SQ FT).
7. The **Pages, Bookmarks** window displays the grid's properties.
8. The area takeoff for the rebar is 13316.8 SQ FT.
9. The grid's calculated linear footage is 888.1 FT.
10. The number of intersections is 1480.

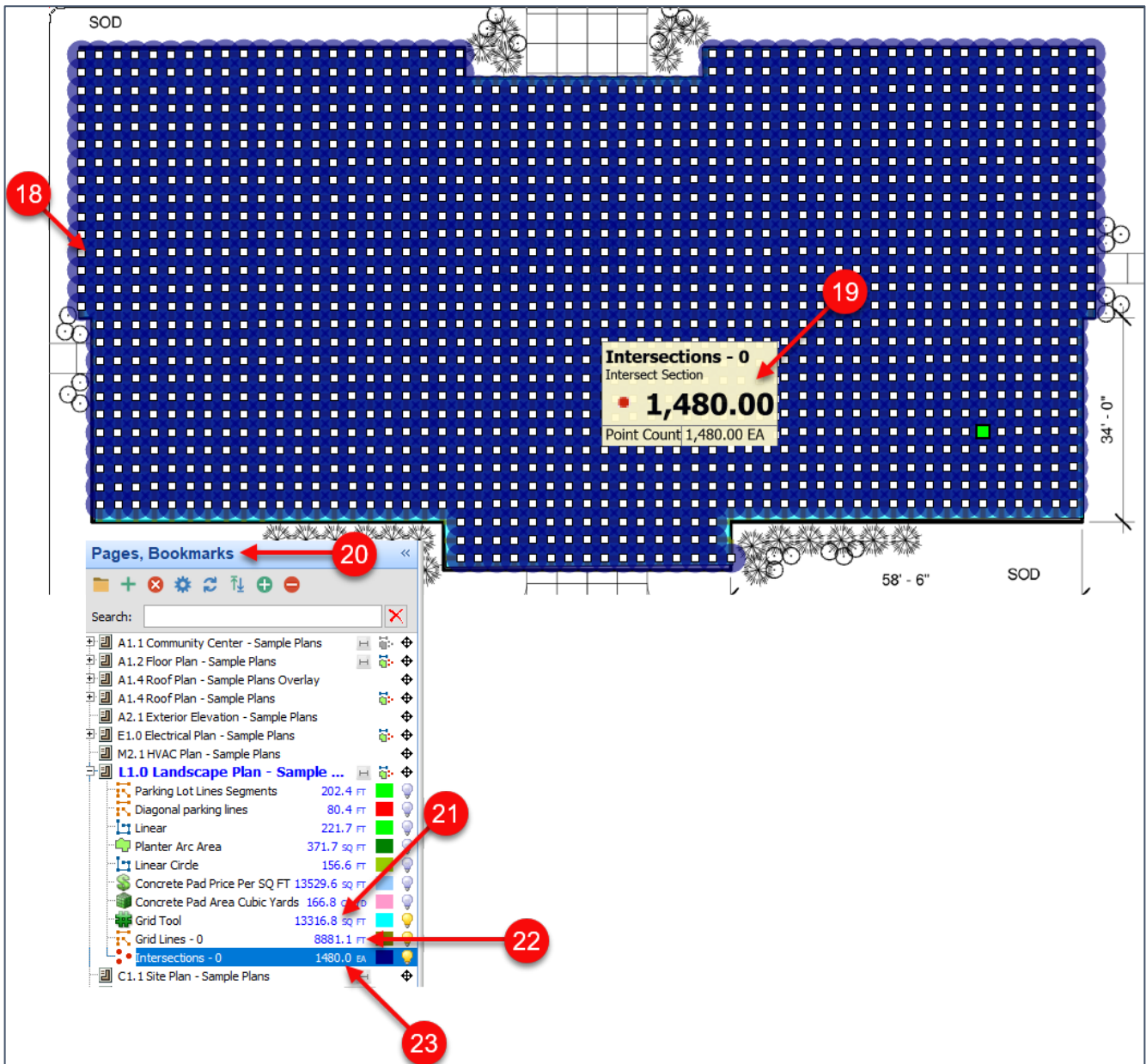

Figure 35-C

- 11. Click on the **Estimating** tab of the PlanSwift main menu (Fig. 35-D).
- 12. Rebar lengths are shown in this view.
- 13. This view also shows the number of intersections where rebar high chairs may be needed.

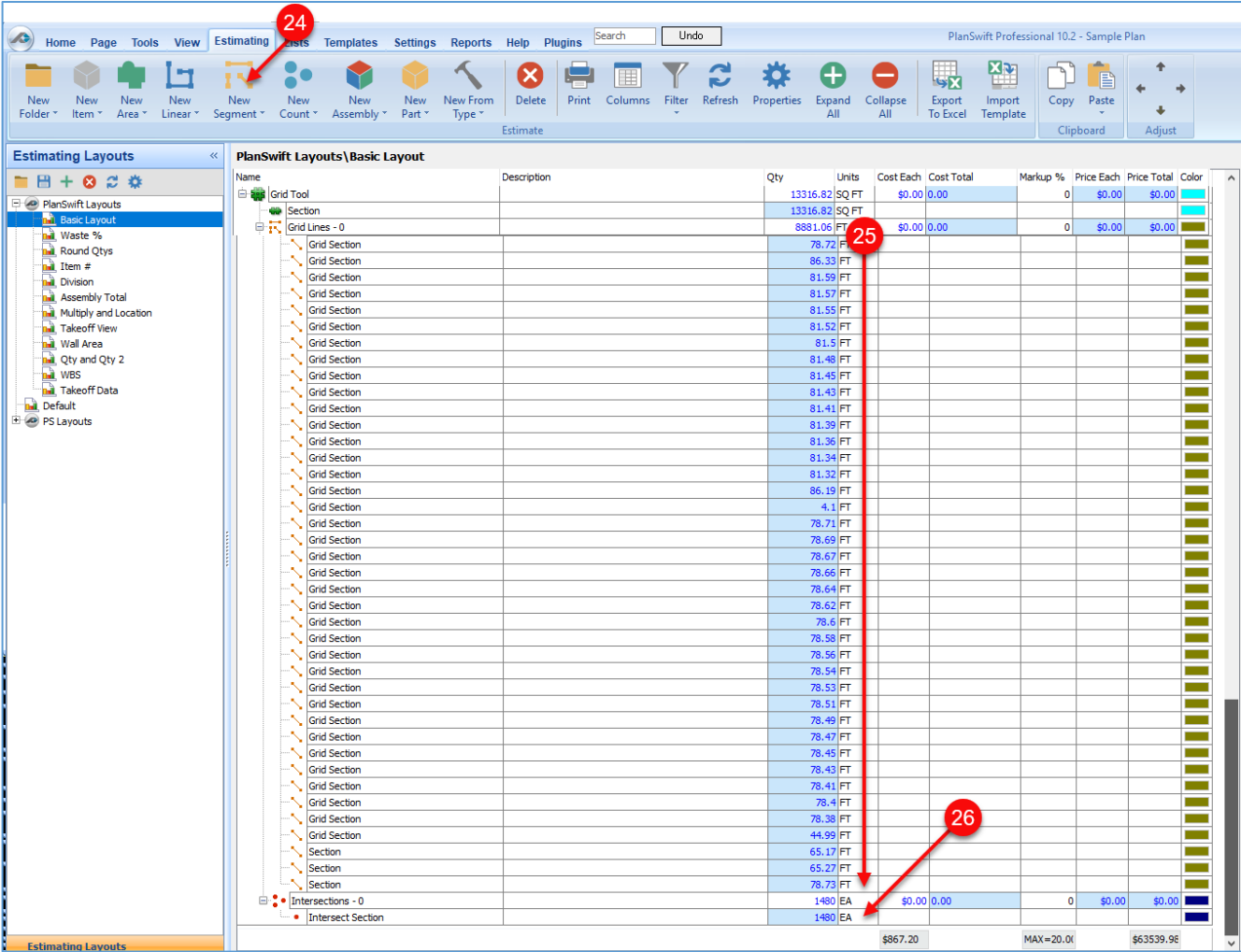

Figure 35-D

---

## Joist Tool Area Takeoff

Performing a **Joist Tool Area** takeoff requires familiarity with performing an [area](#) takeoff. The **Joist Tool Area** takeoff is useful for automatically calculating joists, rafters, and rake walls (to calculate stud lengths). When using the **Joist Tool** for rafters, the rafter application requires a slope to be entered. To perform a joist tool area takeoff:

1. Click on the drop-down half of the **Area** button and select **Joist Tool** from the drop-down menu (Fig. 36-A).
2. This opens the **Properties – [Joist Tool]** window. Enter a name, such as “First Floor Joist Takeoff”, for the joist takeoff.
3. Enter the joist type, such as TJI-560, in the **Joist Type** field.
4. Enter the length calculation method to be used in the **Length Calculation** field.

The drop-down menu options are:

- a. **None** (which will produce a joist length in feet and inches)
  - b. **Nearest Foot** (which rounds the value up to the next whole foot number)
  - c. **Nearest Even Foot** (which rounds the value up to the next even foot)
  - d. **Nearest 2 Feet** (which rounds up to the nearest whole number, adds one and then, if the result of that is odd, adds one more). For this calculation, select **Nearest Even Foot**.
5. Enter the joist direction in the **Joist Direction** field. The drop-down menu options are:
    - a. **First Two Points** (joists will be parallel to the first two **Points** of your takeoff)
    - b. **Horizontal** (joists will be drawn horizontally)
    - c. **Vertical** (joists will be drawn vertically)
    - d. **Select Parallel Side** (allows you to draw joists parallel to a side of the plan by selecting two **Points**). If this is selected, then the **Automatically Generate** option is disabled.

Select **Parallel Side**.

6. Enter the on-center spacing in the **O.C. Spacing** field. Values in the drop-down menu are: **8, 12, 16, 19.2, 24, 32**, or you can enter a different value. Select 24.
7. The **Pitch** field is used for rafters. Enter zero for joists. For rafters, enter the pitch of the rafter. Leave this blank or at zero.

- 
8. The **Min Length** is the shortest size of material available for purchase. Leave blank.
  9. The **New Length** is the length of the material that will be ordered. Leave blank.
  10. Select the color in the **Color** field for the takeoff.
  11. Select the **Fill Type** in the **Fill Type** field (**Solid, Hatch Pattern, or Texture**).
  12. The **Group Sections** is used when you have multiple joist sections that are all the same. As an example, a five-story building might have the same joist design for each floor. By breaking out each of the sections (floors) separately, it is easier to estimate the cost of each floor. Do not select this.
  13. Clicking on **Generate Parts** will generate a part for each joist in the Estimating screen and will group joists of the same length into the same part. Select this.
  14. Clicking on **Automatically Generate** will generate the joist takeoff locations automatically after the area takeoff is completed, but only if the **Select Parallel Side** joist direction is NOT selected. If you need to add double joists or split joists, you may not want to select the **Automatically Generate** option. For this exercise, do not select this.
  15. Clicking on **Show Labels** will generate labels showing the length of each joist. Select **Show Labels**.
  16. Click on **Ok** to continue.

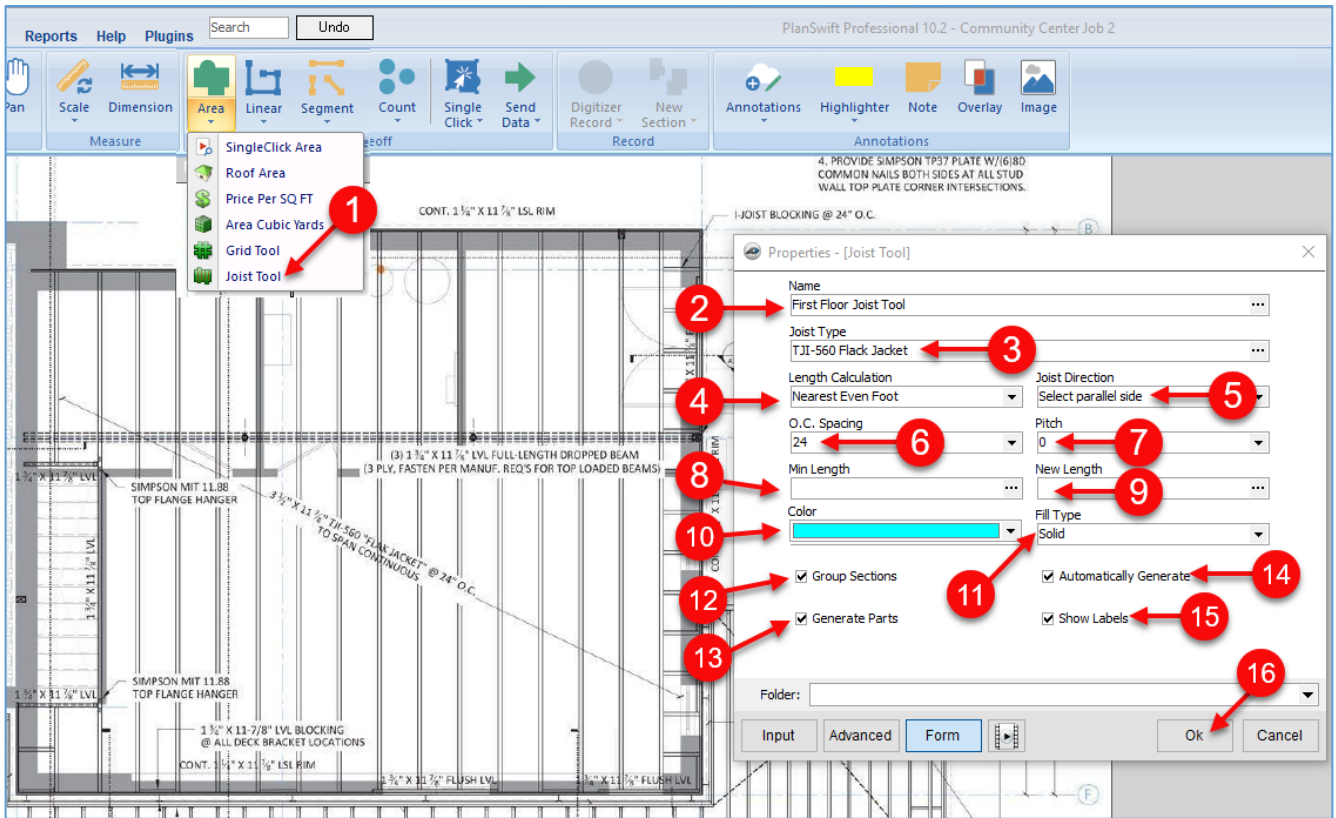

Figure 36-A

17. Starting at the arrow, perform the takeoff using the standard takeoff procedure (Fig. 36-B).
18. Complete the takeoff by selecting **Stop** from the right-click menu or by pressing the **Esc** key.

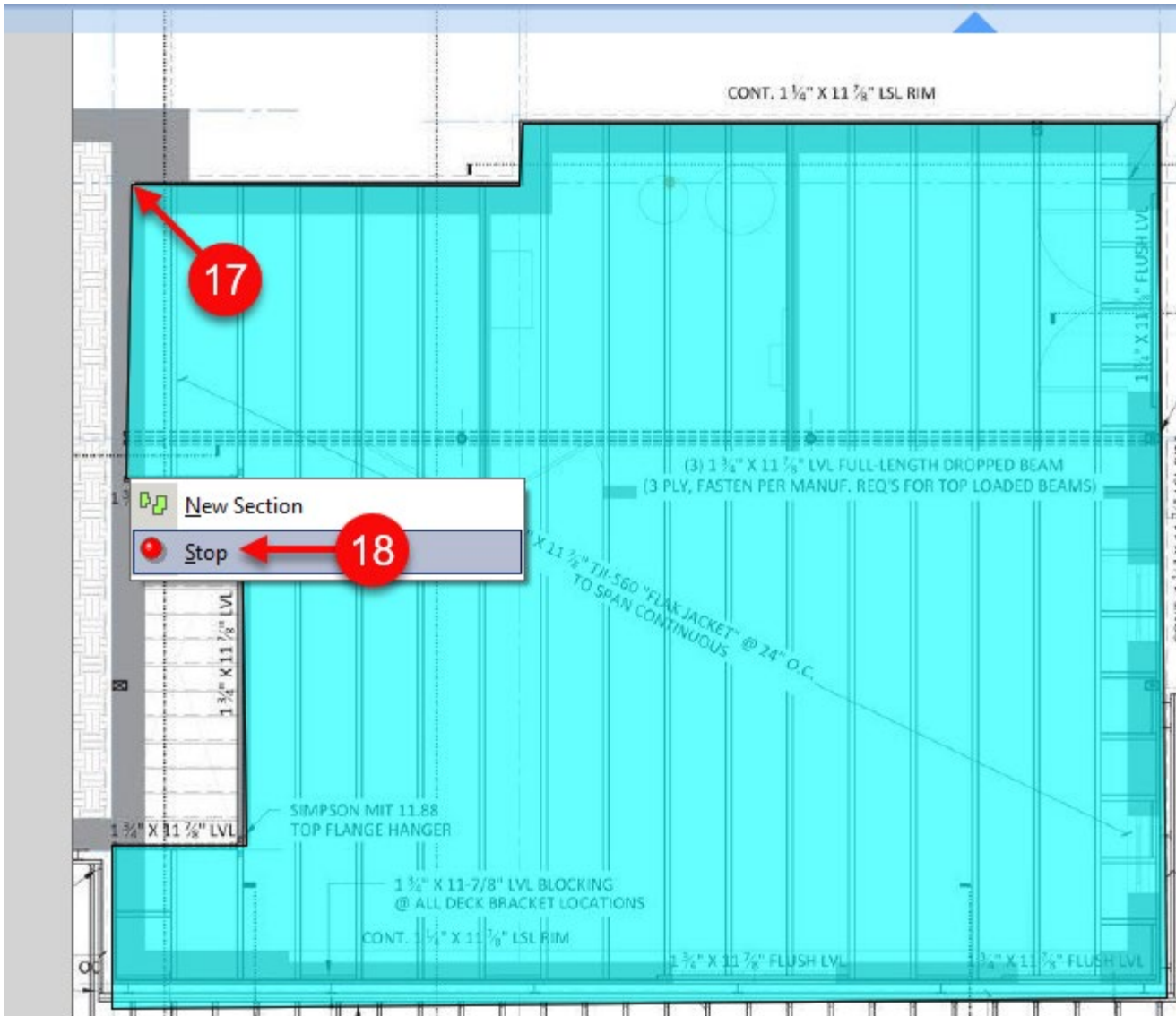

Figure 36-B



19. Click on the completed takeoff to select it, which highlights the takeoff in a red border (Fig. 36-C).

20. Four selections now appear:

- a. **Draw Joists/Rafters** (which draws the joists/rafters)
- b. **Clear Joist/Rafters** (which clears any drawn joists/rafters)
- c. **Regenerate Totals** (which regenerates totals)
- d. **Split Joists/Rafters** (which splits joists/rafters).

Click on **Draw Joist/Rafters**.

21. You are prompted to click on the first **Point** for placement of the joists, then to click at the second Point (at the other end of the same joist); this creates all of the single joists.

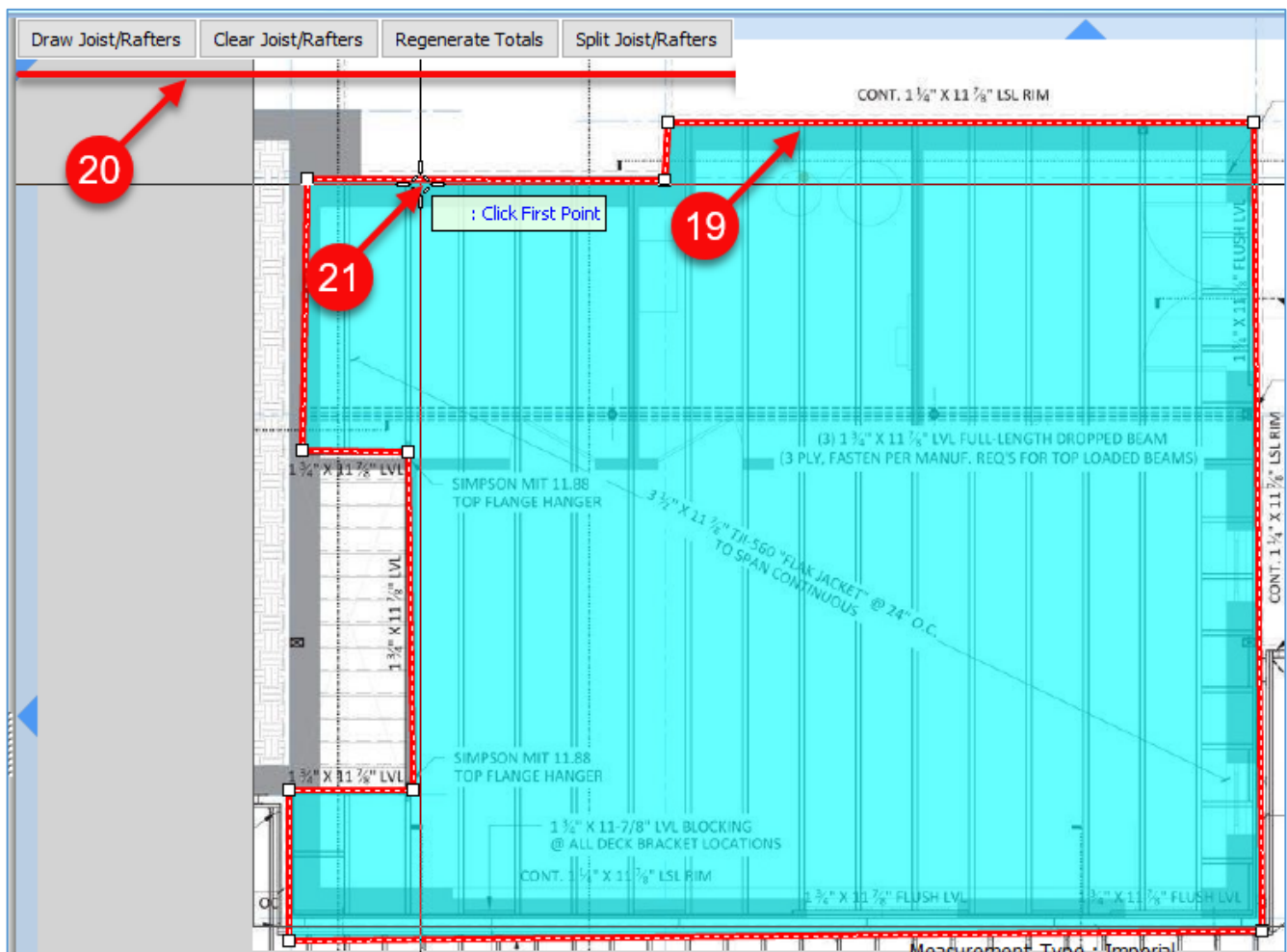

Figure 36-C

22. The “First Floor Joist Takeoff” shows 862.1 SQ FT, and the total length of all joists measures 410.8 FT (Fig. 36-D).

23. The label shows ten 28-FT joists, four 26-FT joists, two 10-FT joists, and two 6-FT joists.

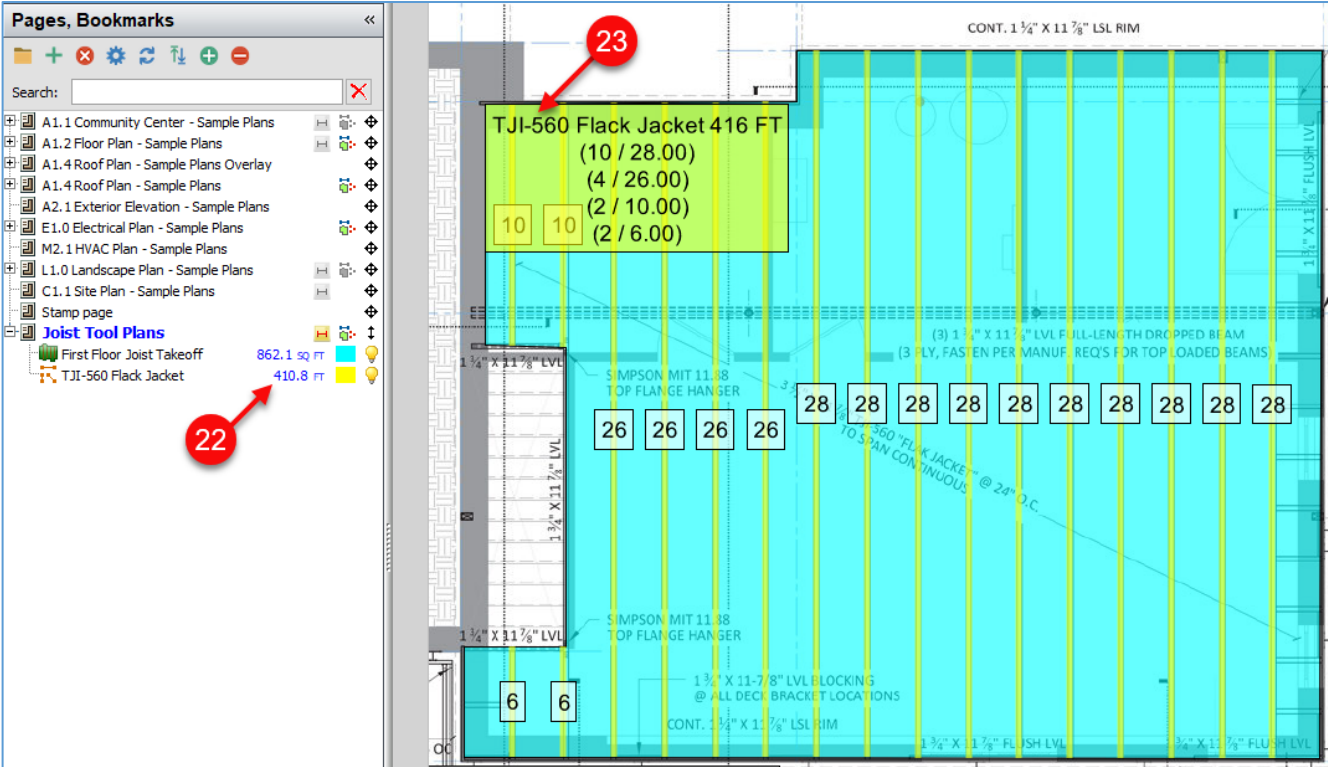

Figure 36-D

24. If you need to double one of the joists, click on a joist to select it so that it is highlighted in red (Fig. 36-E).
25. The **Add Double Joist** button now appears. Click on it.
26. The doubled joist appears next to the one that was selected.
27. The note automatically updates to show eleven 30-FT joists.

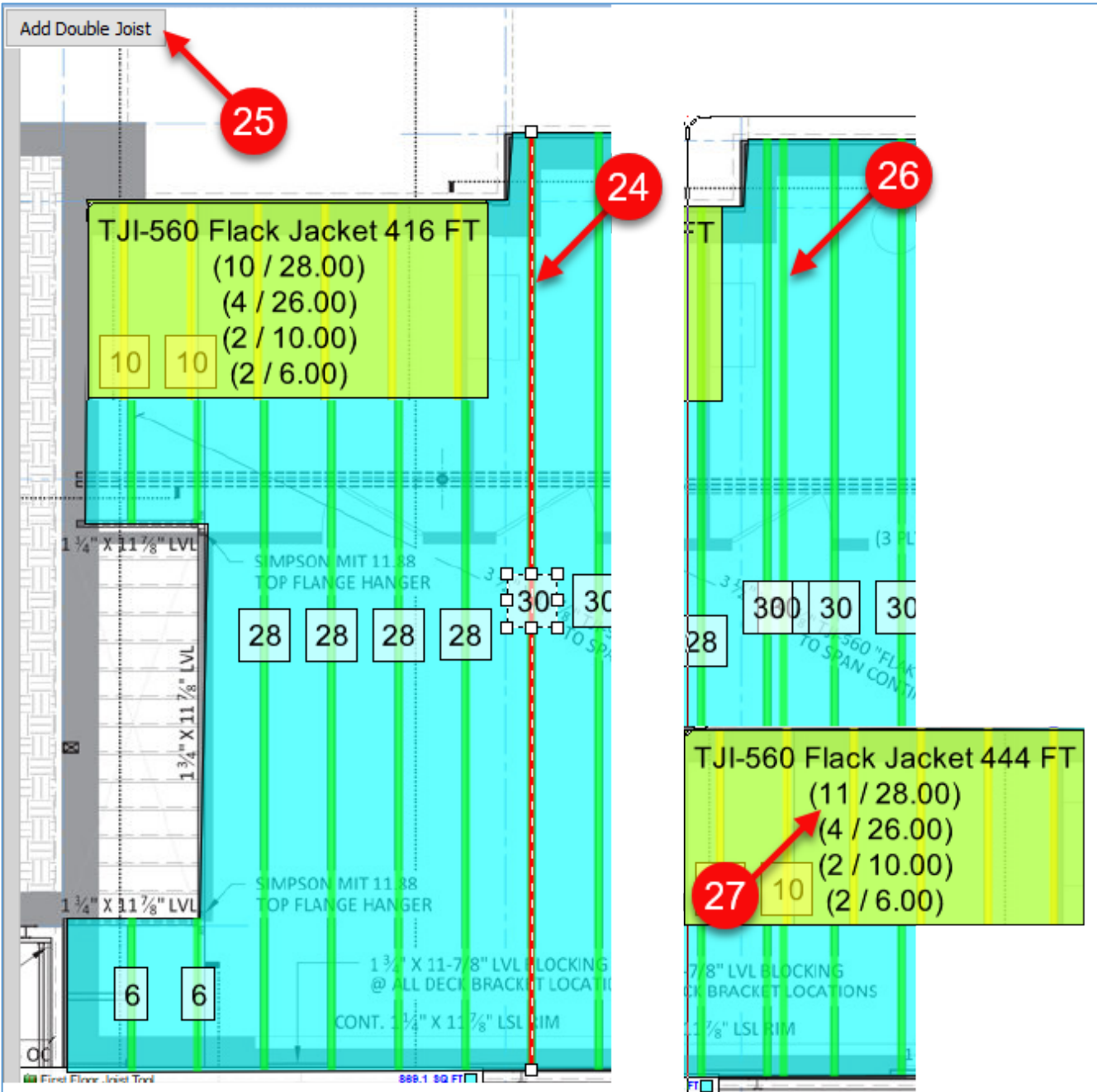

Figure 36-E

28. If you want to split the joists and rafters, click on the “First Floor Joist Takeoff” area (Fig. 36-F).
29. Click on the **Split Joist/Rafters** button.
30. Click on the first **Point** (the left side of the dropped beam in this example).
31. Click on the second **Point** (the right side of the dropped beam in this example).

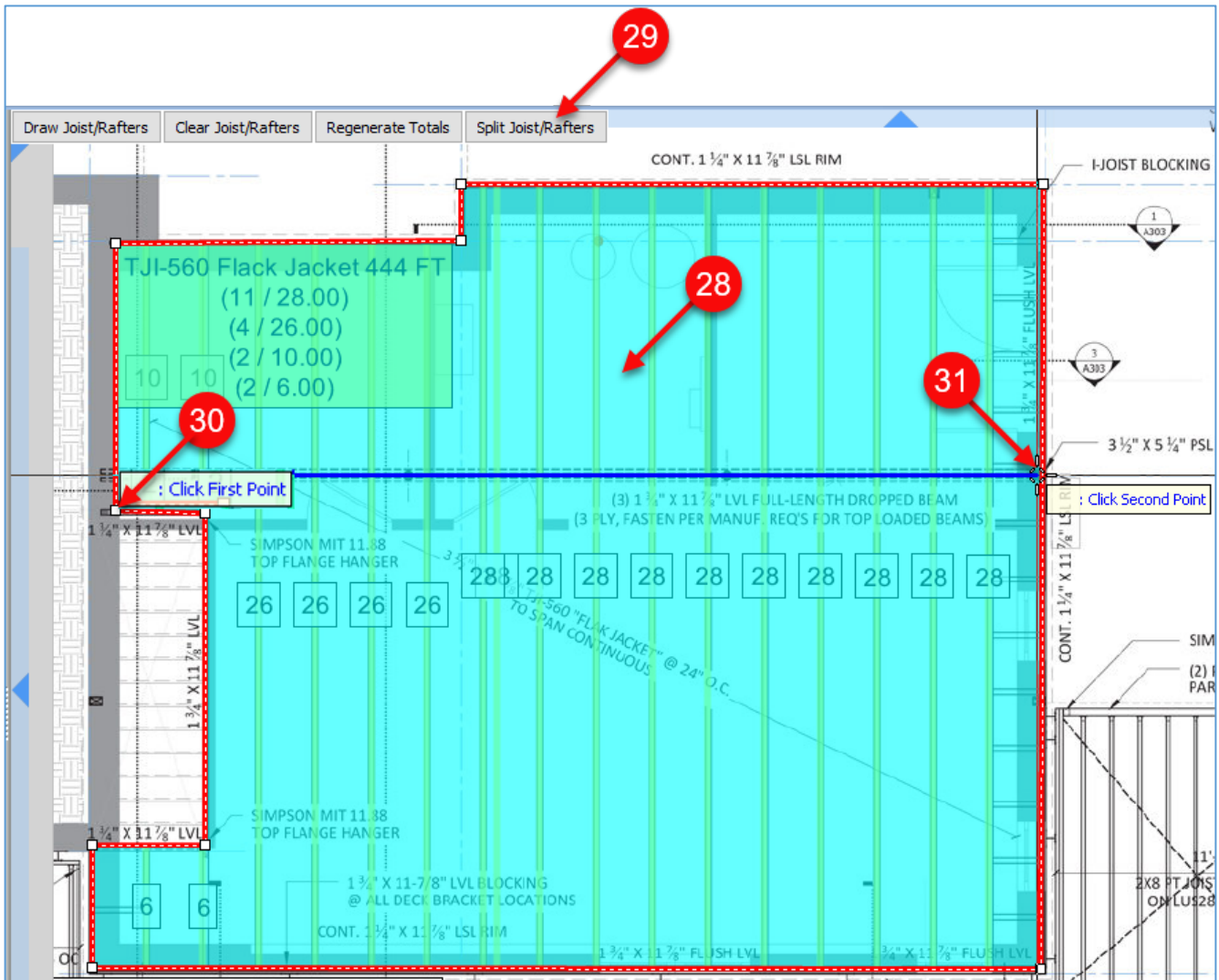

Figure 36-F

32. The split joists appear. Note that the 28-FT joists are now split into a 12-FT and an 18-FT joist (which makes 30 total feet). The extra two feet are added because the rounding option was set to **Nearest Even Foot**, and each of the joists had a foot added to them (Fig. 36-G).

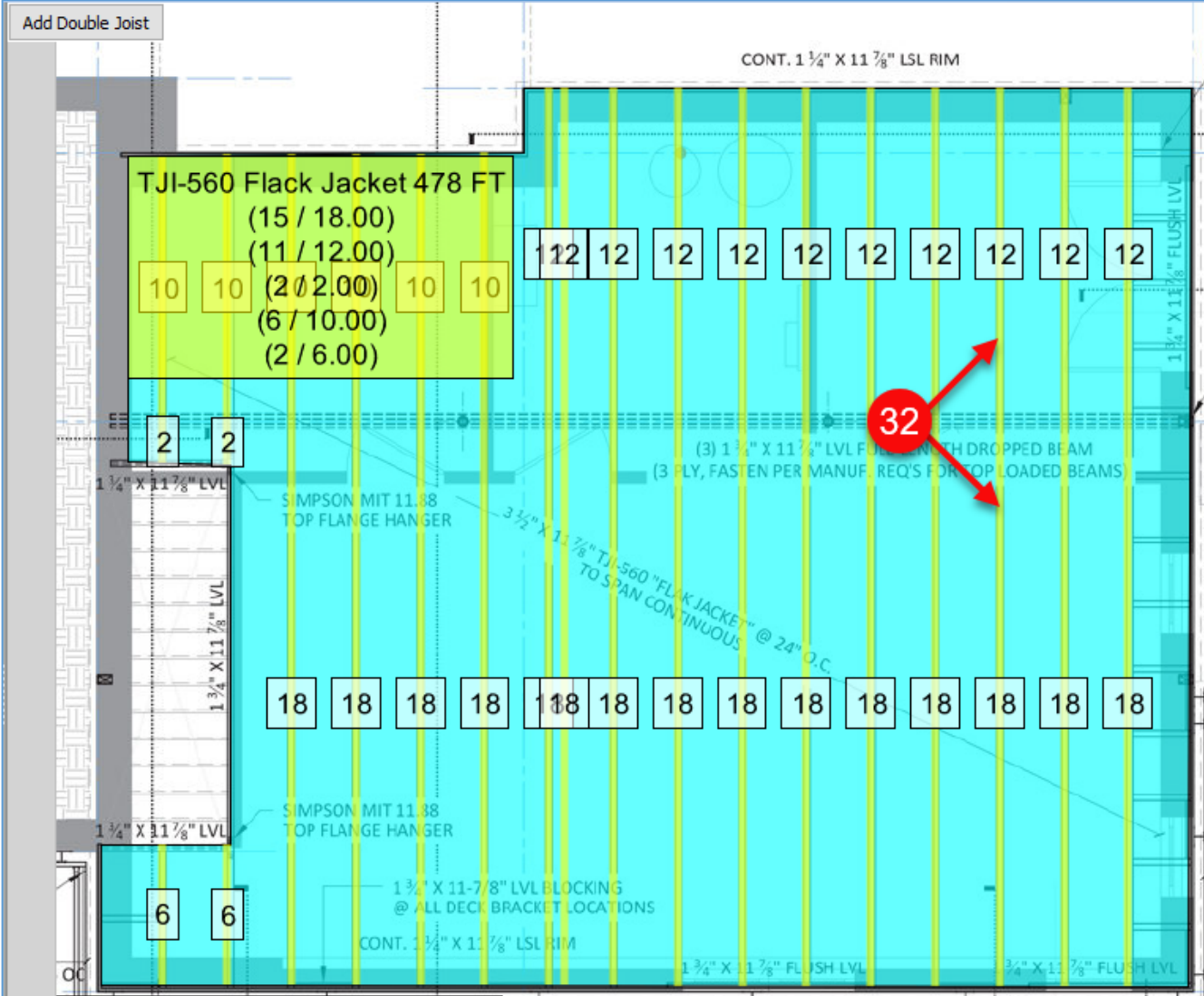

Figure 36-G

33. If you want to change the rounding properties or any other joist properties, double-click on the area takeoff (or right-click on the area takeoff and select **Properties** from the drop-down menu) (Fig. 36-H).
34. After making any changes to the properties, click on **Ok** to close the **Properties** window.
35. Click on **Regenerate Totals** to have the properties updated.

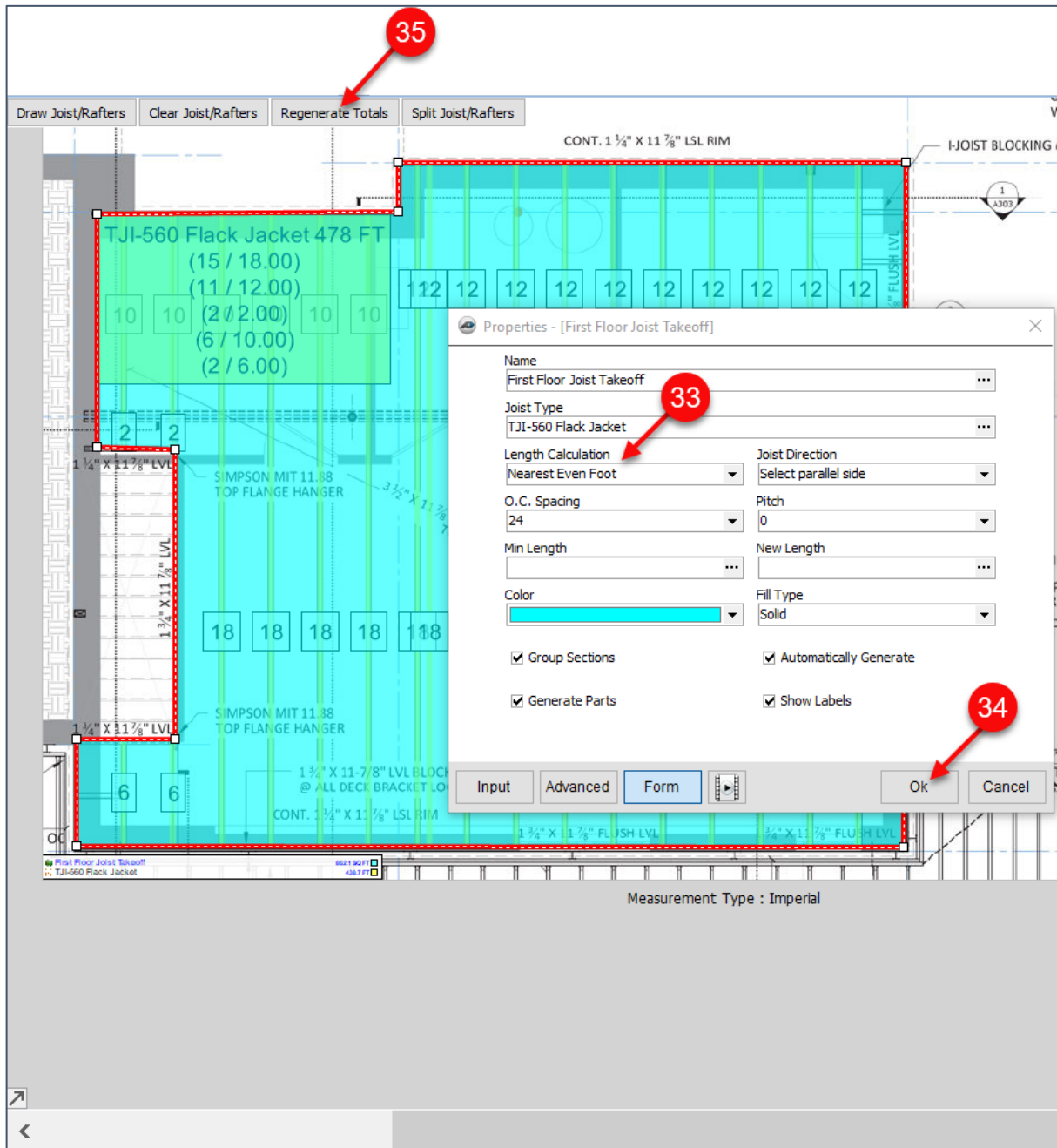

Figure 36-H

- 36. Click on the **Estimating** tab of the PlanSwift **Main** menu (Fig. 36-I).
- 37. The joist estimates are listed in the Estimating screen.

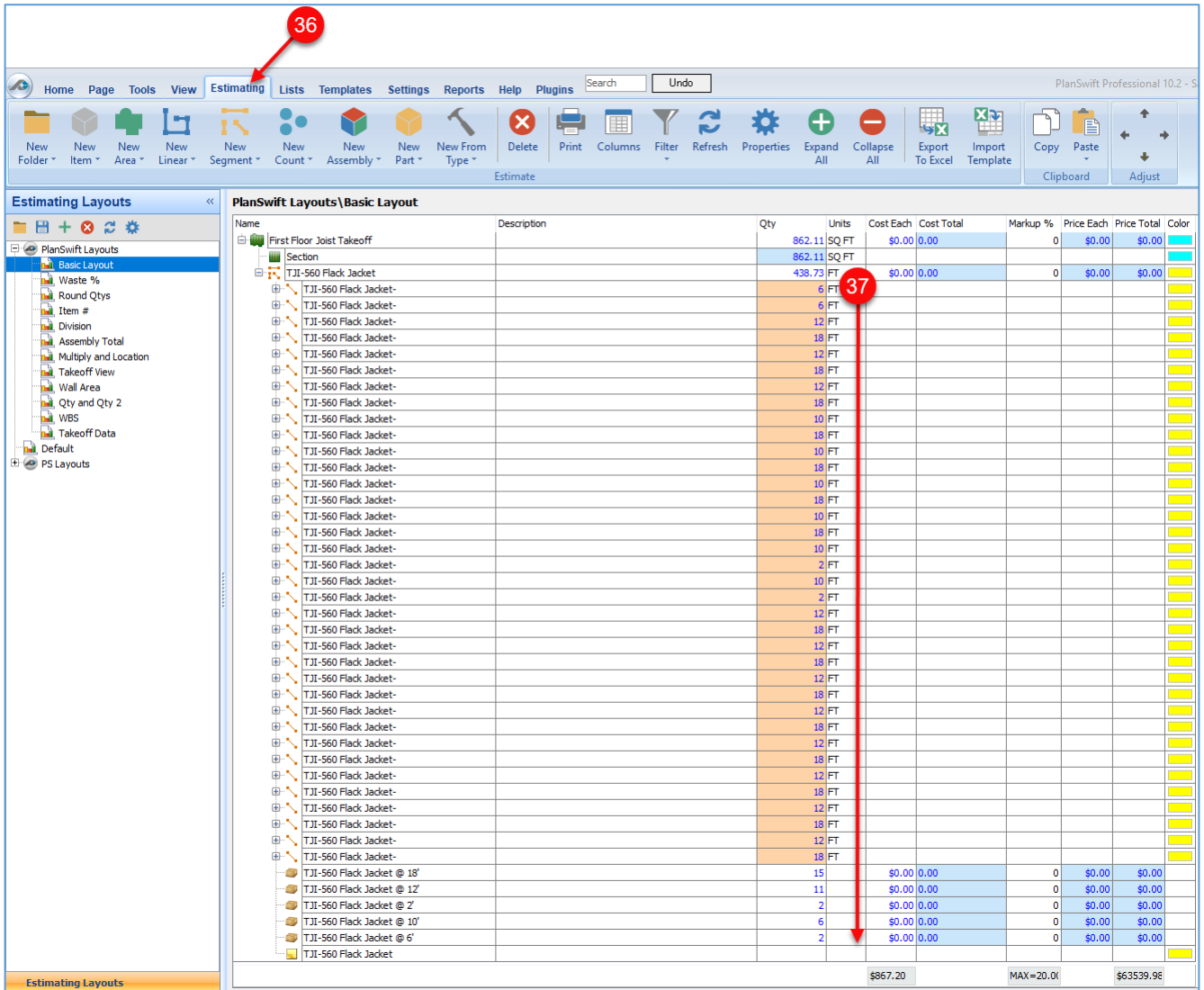

Figure 36-I

---

# Shortcuts and Hotkeys

## Shortcuts for Zooming, Panning, and Navigating Pages

PlanSwift provides shortcuts for [Zooming](#), [Panning](#), and [Navigating Pages](#).

### Zooming

Four zoom commands are available from the **Zoom/Pan** group on the **Home** tab ribbon-bar (Fig. 37-A). PlanSwift provides several ways of invoking these commands:

1. Clicking on **Zoom**, then selecting an area of the page by clicking and dragging the cursor over an area of the page selects the area that is drag over and zooms in to display the selected area. An alternate way of zooming into a selected area is to press the **F10** function key and drag over the area with the mouse.
2. Clicking on **Fit Page** displays the entire plan page in the viewing window and pans the image so that the image is centered in the viewing window. An alternate way of fitting the page to the window is to press the **F7** Function key.
3. Clicking on **Zoom In** zooms in about 30% each time it is clicked on. A second way of zooming in is to use the mouse wheel, and a third way is to press the number pad's + (plus) key. The number pad zoom functions are smoother and only zoom in or out about 10%.
4. Clicking on **Zoom Out** zooms out about 30% each time it is clicked on. A second way of zooming out is to use the mouse wheel, and a third way is to press the number pad's – (minus) key.

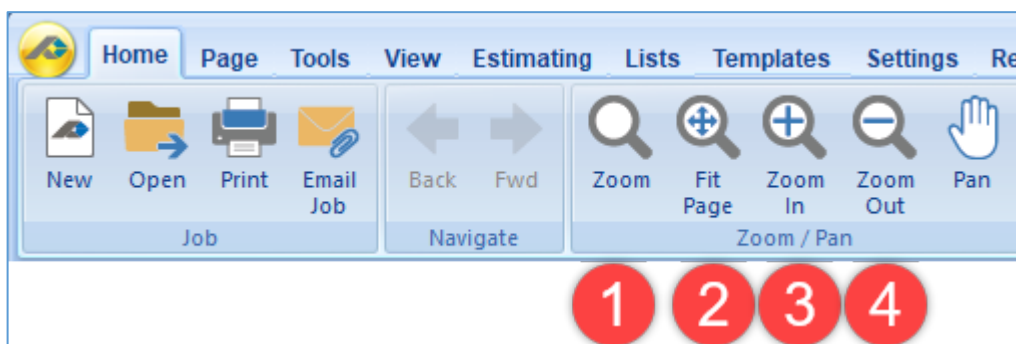

Figure 37-A



## Panning

The **Pan** option can be initiated in three ways:

1. Click on the **Pan** button on the **Zoom/Pan** group on the **Home** tab ribbon-bar (Fig. 37-B) and drag with the left mouse button held down.

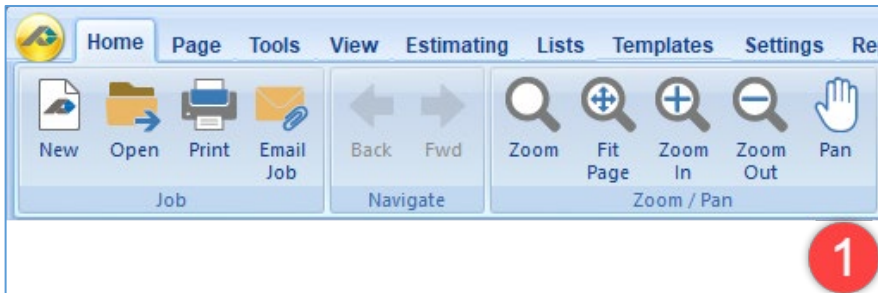

Figure 37-B

2. Click and hold the right mouse button while dragging. This automatically highlights the **Pan** button on the **Main** ribbon-bar menu as you drag to pan the image.

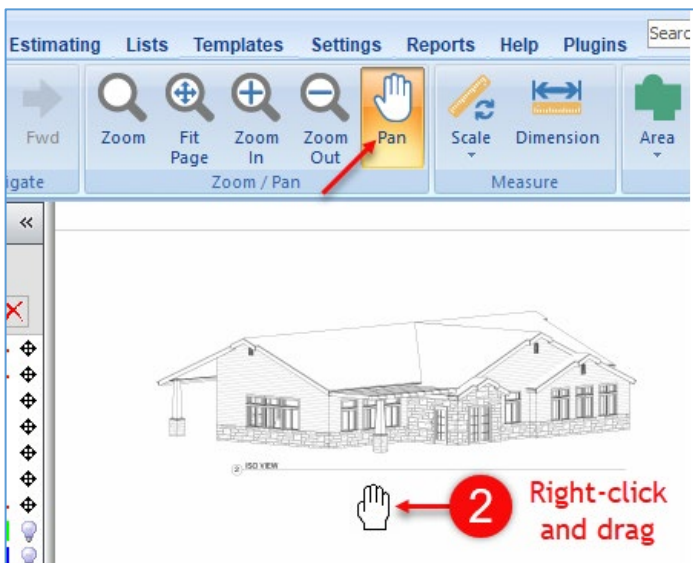

Figure 37-C

3. Press the **E**, **D**, **F**, and **S** keyboard keys to scroll up, down, left, and right, respectively.

## Navigating Pages

The Navigate arrows options are available from the **Navigate** group on the **Home** tab ribbon-bar (Fig. 37-D). To navigate from page to page:

1. The left navigate arrow opens the previous page. An alternate way of moving to the previous page is the **Pg Up** keyboard key.
2. The right navigate arrow opens the next page. An alternate way of moving to the next page is the **Pg Dn** keyboard key.

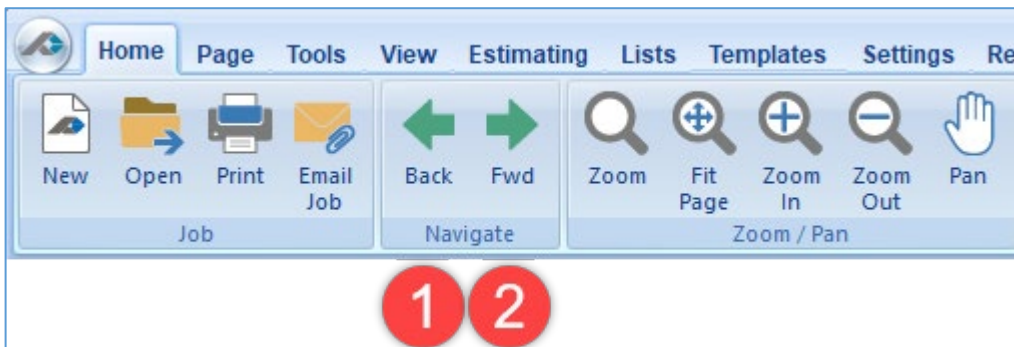

Figure 37-D

# Using and Customizing Keyboard Hotkeys

PlanSwift provides a means to customize hotkeys:

1. The **Zoom to Fit** and **Zoom** hotkeys can be changed here (Fig. 38-A).
2. The **Scroll Up**, **Scroll Down**, **Scroll Left**, and **Scroll Right** hotkeys can be changed here.
3. The **Magnifier** hotkey can be changed here.
4. The number-pad zoom (**Smooth Zoom In** and **Smooth Zoom Out**) can be changed here.
5. The numbers **1**, **2**, **3**, and **4** are used to start new areas, new linears, new segments, and new counts and can be changed here.
6. **Digitizer Record**, **New Section**, **Toggle Image/Estimating Window**, and the **New Note** can be changed here.



Figure 38-A

# Integration with Excel

PlanSwift makes it easy to send takeoff and estimating data to Microsoft Excel. Data between PlanSwift and Excel is managed in three key ways:

1. Exported to Excel using the [Export to Excel](#) feature.
2. Imported from Excel using the [Excel Import Tool](#) plugin.
3. Live-linked with Excel using PlanSwift's **Integration with Excel** feature.

Besides easily being able to [Export data to Excel](#), PlanSwift's **Integration with Excel** provides the ability to live-link to and update Excel WorkBooks in real-time, initiate and add to PlanSwift takeoffs, navigate easily from Excel takeoff values to PlanSwift takeoff values, assign multiple properties to a single takeoff, export Excel templates from Excel back into PlanSwift, and unlink a job. This functionality is provided via a **PlanSwift Ribbon-bar Tab** and via a **Right-click Menu**.

## PlanSwift Ribbon-bar Tab

The **PlanSwift Ribbon-bar Tab** (Fig. 39-A) is visible once PlanSwift is installed and Excel is started.

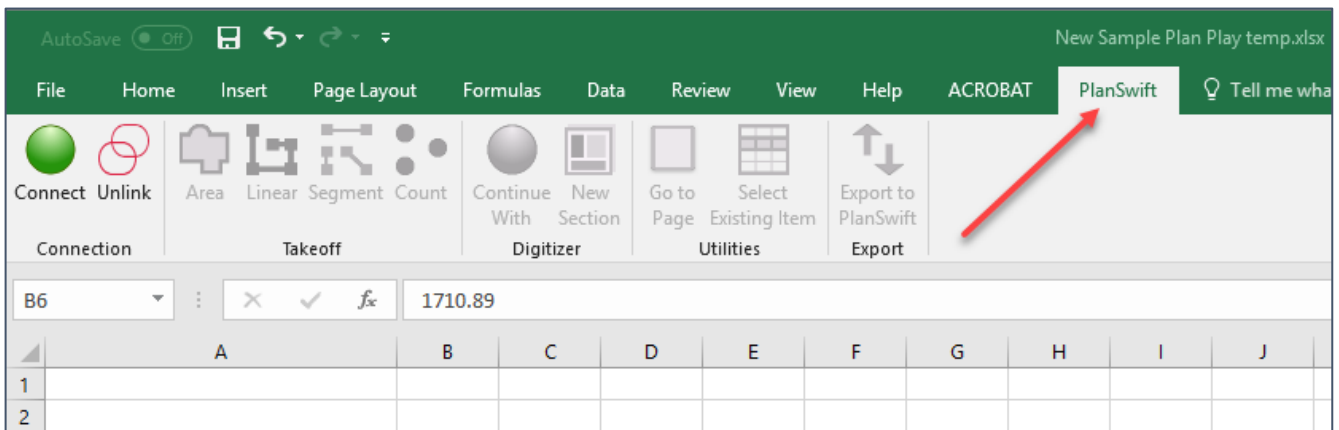

Figure 39-A

1. Click on the **PlanSwift Ribbon-bar-Tab** (Fig. 39-A) so that the PlanSwift Ribbon-bar icons are visible.

## Connecting to and Disconnecting PlanSwift from Excel

Connecting to Excel links PlanSwift and PlanSwift Excel Integration into a live-link so that the powerful features in Microsoft Excel and PlanSwift can be utilized. To connect and disconnect PlanSwift from Excel:

1. Open PlanSwift and open the job that you want to link the PlanSwift Excel Integration.
2. Open Excel to the spreadsheet to which you want PlanSwift linked and click on the **PlanSwift Ribbon-bar Tab**.
3. In Excel, click on the **Connect** (green orb) icon (Fig. 39-B). Once you are connected, the other PlanSwift icons on the PlanSwift Excel Ribbon-bar will be available.

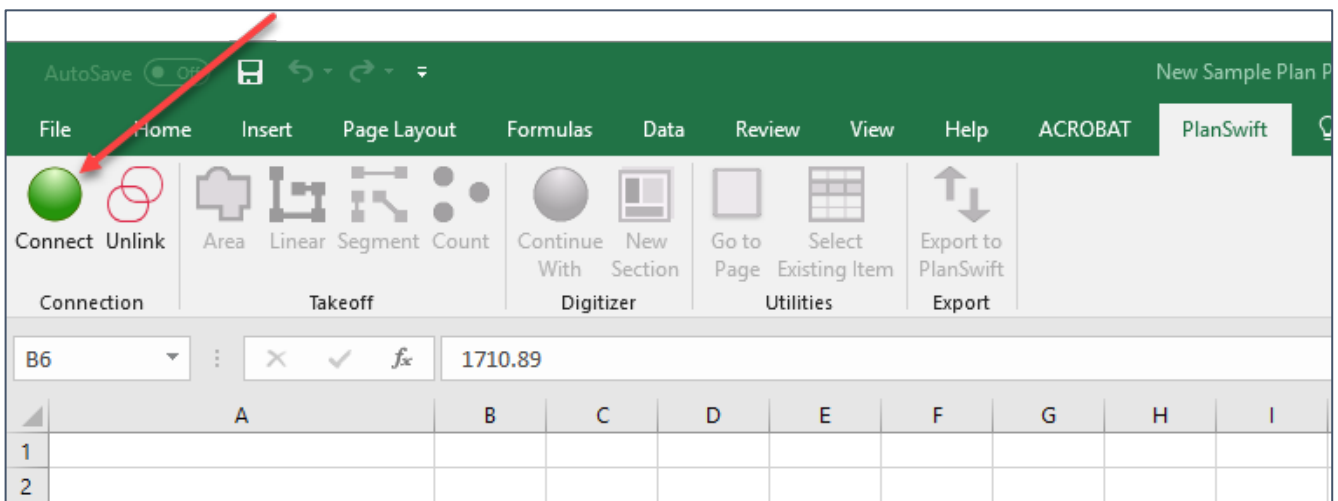

Figure 39-B

4. To disconnect from PlanSwift, click on the **Disconnect** (red orb) icon (Fig. 39-C).

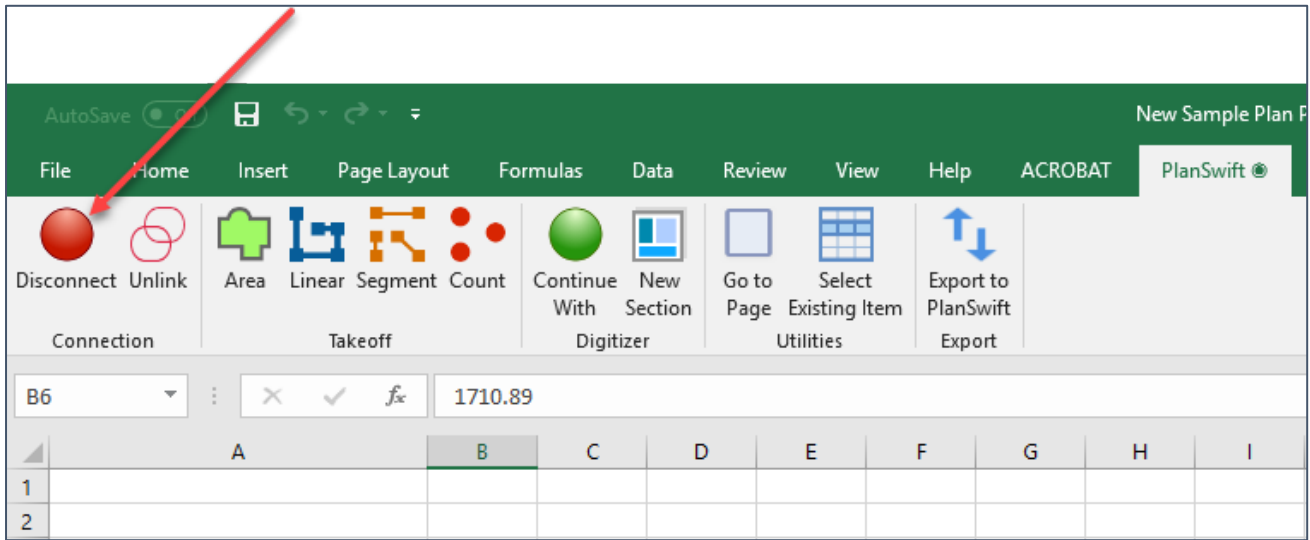

Figure 39-C

## Initiating PlanSwift Takeoffs from Excel

PlanSwift takeoffs may now be initiated from within Excel by following the procedure below. Note that PlanSwift must be open and a job and a floorplan selected before beginning a takeoff. To initiate an area takeoff from Excel:

1. Click on a cell in the spreadsheet where you want the new area value to be stored (Fig. 39-D).

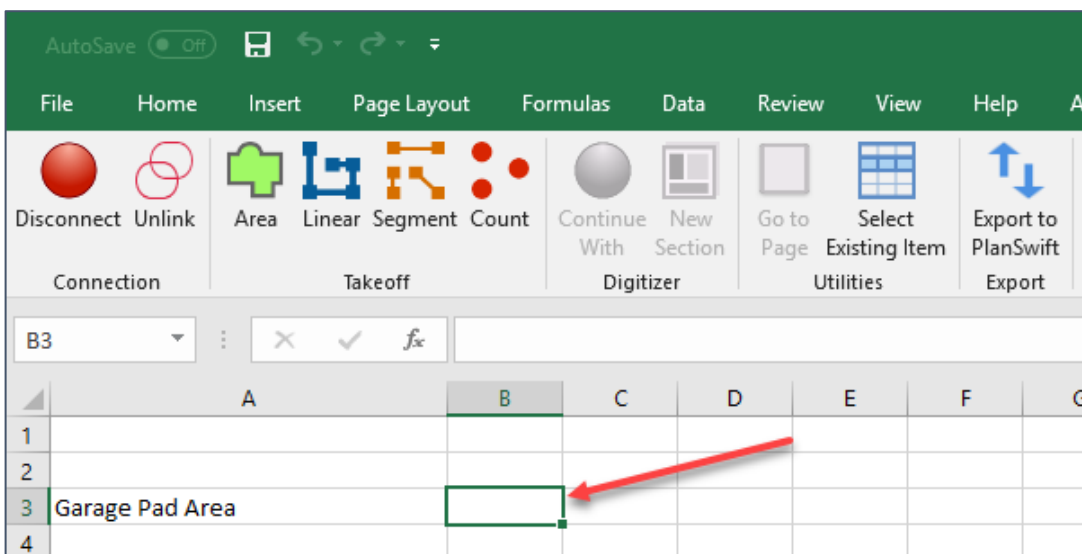

Figure 39-D

2. Click on the **Area** icon in the **Takeoff** group of the **Excel PlanSwift Ribbon-bar** (Fig. 39-E).

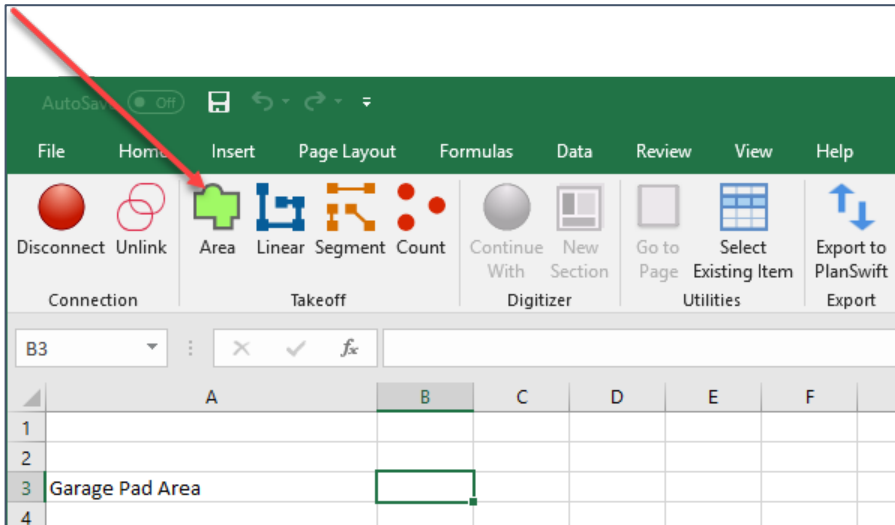

Figure 39-E

3. A **Properties - [New Area]** window appears in PlanSwift allowing you to give a **Name** to the area takeoff (Fig. 39-F). Enter a name of your choice and click **Ok**.

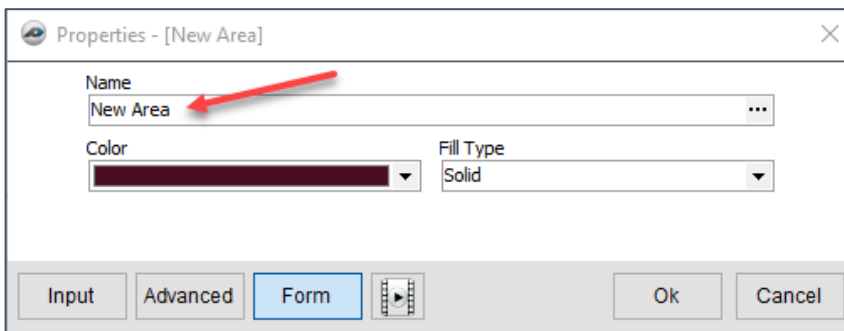

Figure 39-F

PlanSwift is now ready for you to perform an area takeoff. Perform the takeoff, and the takeoff value will appear in the cell you selected. That value and the name of the takeoff will also appear in PlanSwift. The **Linear**, **Segment**, and **Count** takeoffs all work similarly to the **Area** takeoff you just performed. If you make any changes to the takeoffs in PlanSwift, those changes are automatically updated through the PlanSwift Excel Integration, as long as Excel remains connected to PlanSwift.

## Adding New Sections to Takeoffs

The **Digitizer** group **Continue With** and **New Section** buttons, which work identically in Excel, are used to digitize (or add) a new section to a takeoff. Follow the procedure below to add a new section to an existing takeoff. Note that PlanSwift must be open and a job and a floorplan selected before you can add a new section to a takeoff. To add a new section to a takeoff:

1. Click on an active takeoff cell (containing a takeoff value) within your linked Excel spreadsheet to activate these icons (Fig. 39-G).

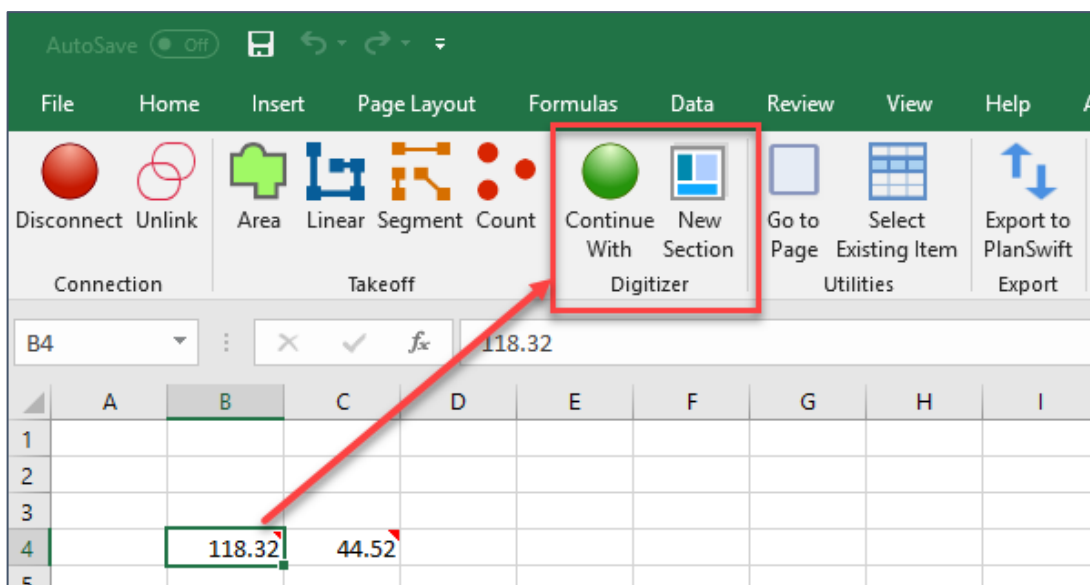

Figure 39-G

2. Click on either **Continue With** or **New Section**.
3. PlanSwift is now ready for you to add to your takeoff. Perform the takeoff in PlanSwift, and the value of the new section will be added to the existing takeoff value in the linked Excel spreadsheet. That added value will also be reflected in PlanSwift. If you make any changes to the takeoffs in PlanSwift, those changes will automatically be reflected in Excel, as long as you remain connected to PlanSwift.



## Navigating from Excel Takeoff Values to PlanSwift Takeoff Values

The **Go to Page** option (Fig. 39-H) in the **Utilities** group of the **PlanSwift Ribbon-bar Tab** allows you to select a takeoff value from your linked spreadsheet and click on **Go to Page** to jump to the page and location of the takeoff value in PlanSwift. After the jump, the PlanSwift page where the takeoff value is located is automatically highlighted in reverse video. To move from an Excel cell's takeoff value to the takeoff in PlanSwift:

1. Click on the linked cell where the takeoff value is that you want to find in PlanSwift.
2. Click on **Go to Page**.
3. Click on the page in the **Select Page** window (Fig. 39-I).
4. Go to PlanSwift. The page where the takeoff value is located will be highlighted. Open the page by clicking on the **+**, if necessary, to view the takeoff value (Fig. 39-J).

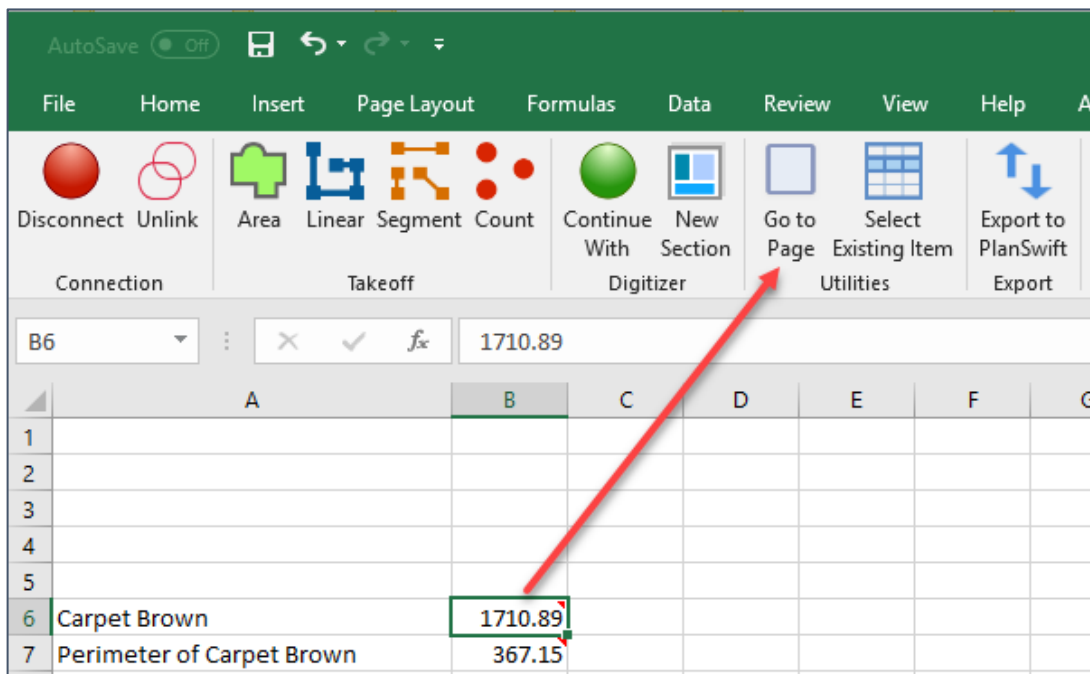

Figure 39-H

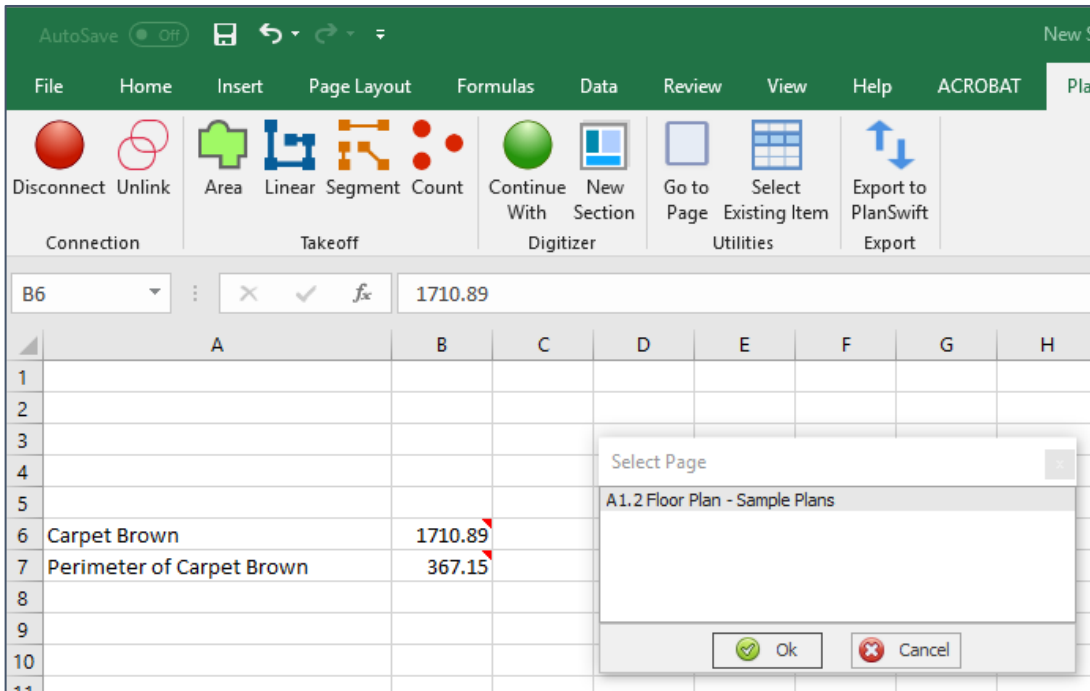

Figure 39-1

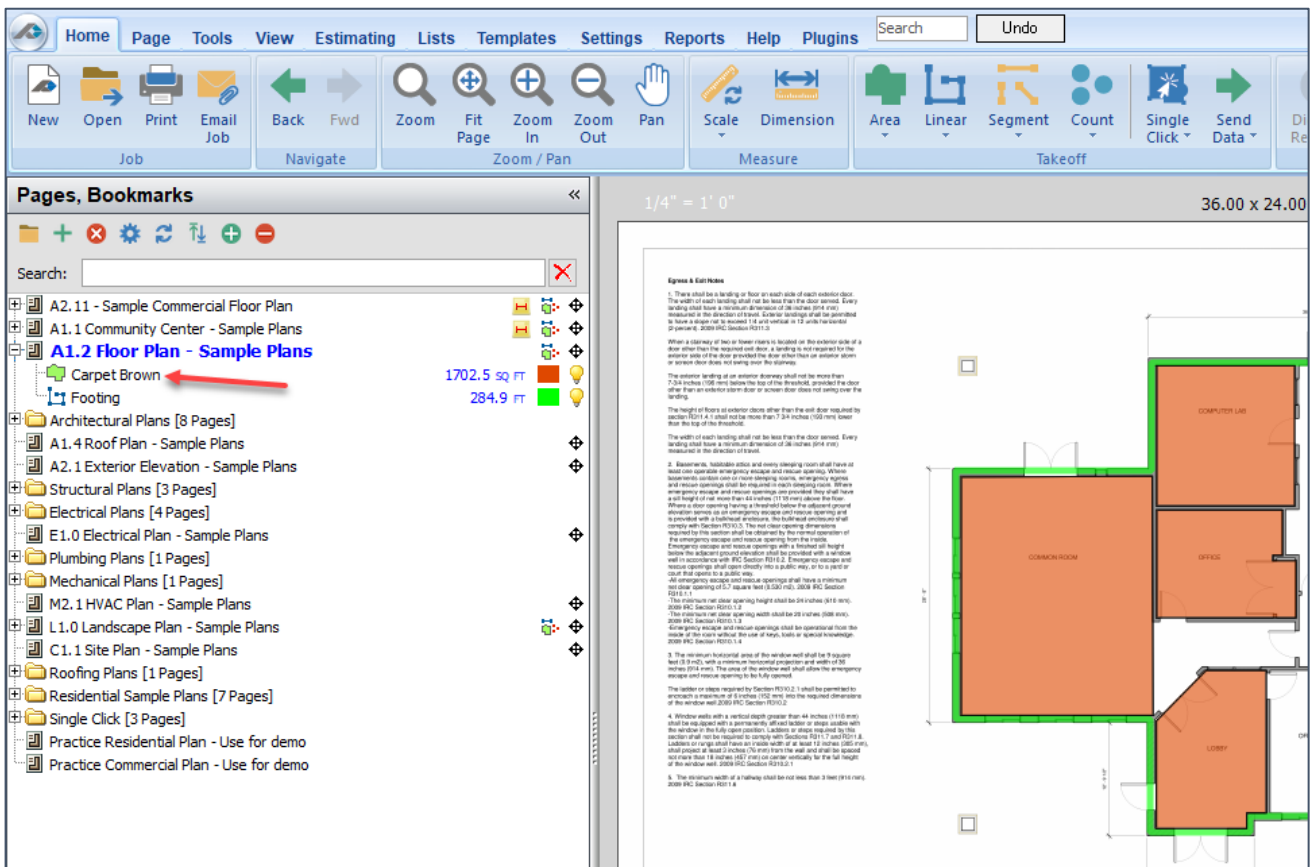

Figure 39-1

## Assigning Multiple Properties to a Takeoff Using 'Select Existing Item'

The **Select Existing Item** option allows you to assign multiple properties to a single takeoff (or item). Follow the procedure below. Note that PlanSwift must be open and a job and a floorplan selected before you can assign a different property to a takeoff.

1. Click on an empty cell in the linked spreadsheet where you want the value of the new property assignment to be stored.
2. Click on **Select Existing Item** (Fig.39-K).

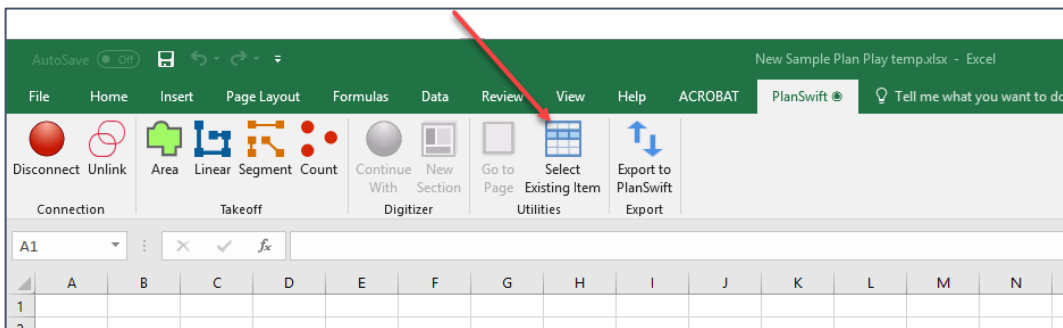

Figure 39-K

3. In the **Select Existing Item** window (Fig. 39-L), click on the item in the left column that you want to use (in this case we are selecting "**Carpet Brown**" which has an "area" property of about 1710 square feet), and then, in the right column, click on **Linear Total**. (Some examples of properties that you might want to use are **Area**, **Linear Total**, **Qty**, **Section Count**, **Segment Count**, and **Depth**, and others are available.)

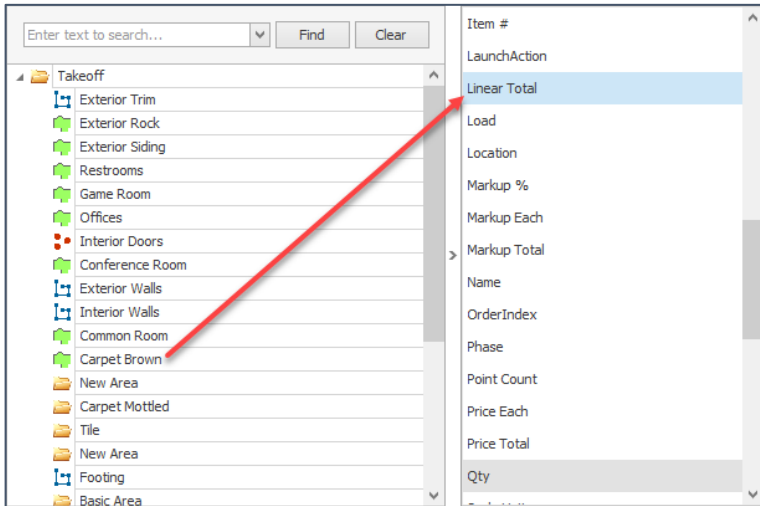

Figure 39-L

4. The result in the linked Excel spreadsheet cell **B7** is 367 linear feet (Fig. 39-M), which is the linear perimeter in feet of the 1710 square-foot **Carpet Brown** takeoff area (shown in cell **B6** of Fig. 39-M). Thus, without having to perform the takeoff twice (once for the carpet area and once for the perimeter of the room, one takeoff can perform both area and perimeter properties.

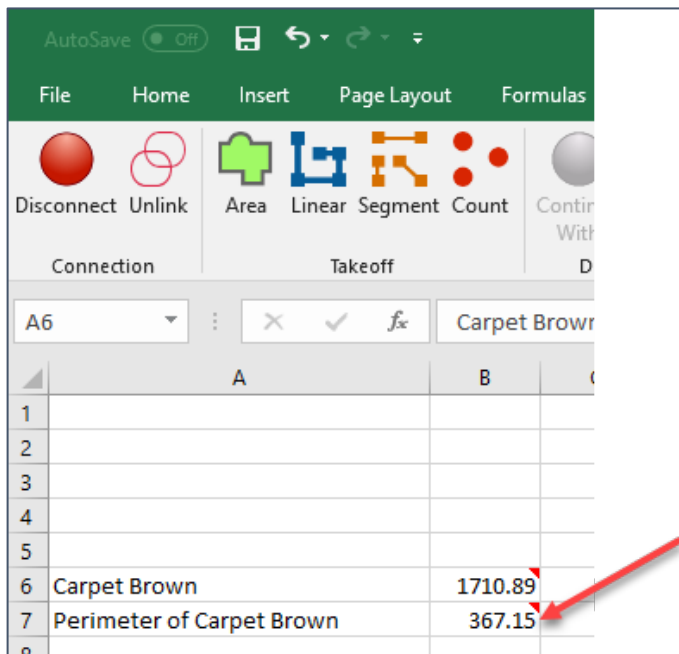

Figure 39-M

## Right-Click Menu

Figure 39-N shows the **Right-click Menu**. As with the **PlanSwift Ribbon-bar Tab**, the **Right-click Menu** is only fully functional when PlanSwift is connected to Excel. When it is not connected, then only the **Connect** button is functional (Fig. 39-O).

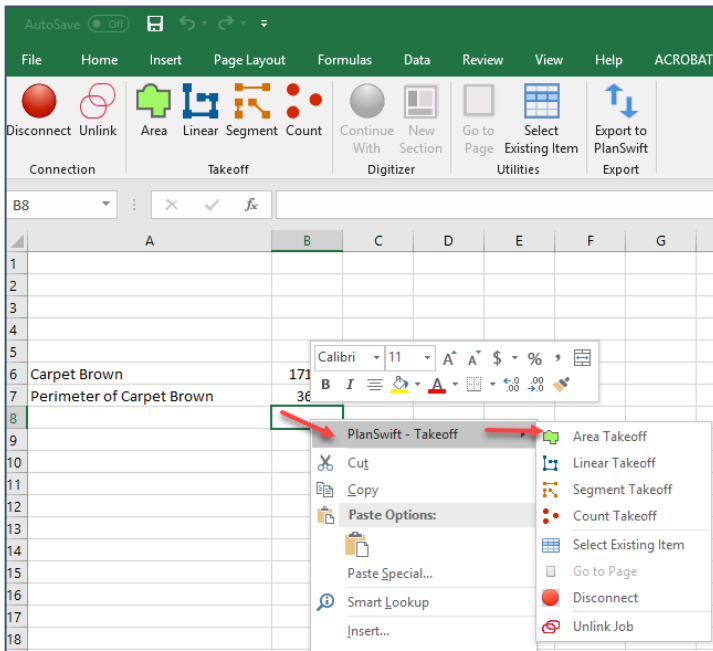

Figure 39-N

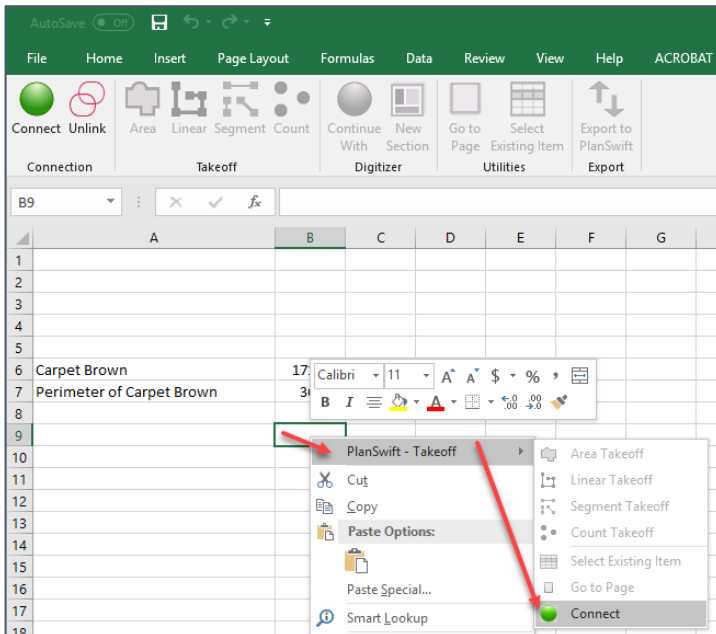

Figure 39-O

## Unlinking a Job

The **Unlink** option on the **PlanSwift Ribbon-bar Tab** (Fig. 39-P) is generally used only when two WorkBooks are accidentally linked to one PlanSwift job. This allows for unlinking a spreadsheet from the PlanSwift job. You are asked to confirm twice. Once you confirm, all cells are unlinked, although their values remain in the Excel spreadsheet.

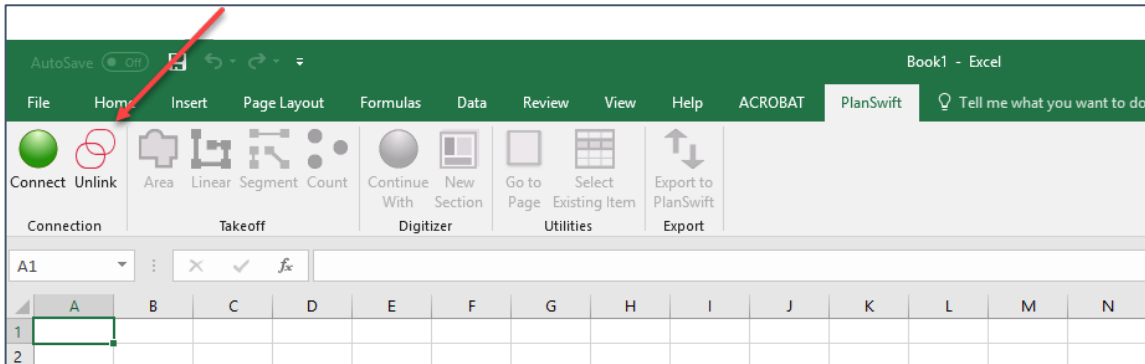

Figure 39-P

---

# Customizing PlanSwift

In addition to being easy to use, PlanSwift Professional is also a powerful software platform due to its customization features and options. In this section, users will be introduced to templates, parts, assemblies, estimating layouts, reports, plugins, advanced features, and an overview for developers. We highly recommend purchasing a [training package](#) for accelerated learning and faster customization.

## Templates Overview

PlanSwift provides a sample library of prebuilt templates, parts, and assemblies. These are found in the **Templates** tab as custom tabs (Fig. 40-A).

1. Sample Templates
2. Sample Parts
3. Sample Assemblies

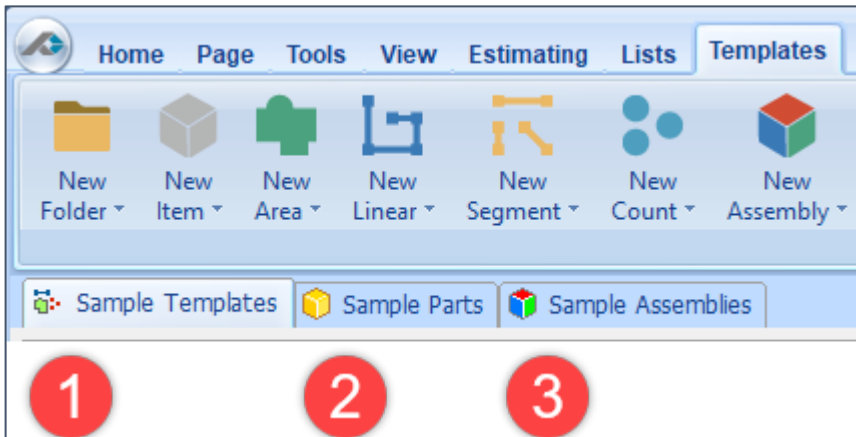

Figure 40-A

With PlanSwift, users can build custom templates to their specific needs and easily modify them. Templates can save users countless hours. PlanSwift also makes available for purchase Starter Packs with pre-setup templates for various construction specialties, such as concrete, flooring, roofing, siding, etc.



We will define templates, parts, and assemblies in this and subsequent sections.

1. Figure 40-B shows the **Sample Templates**.

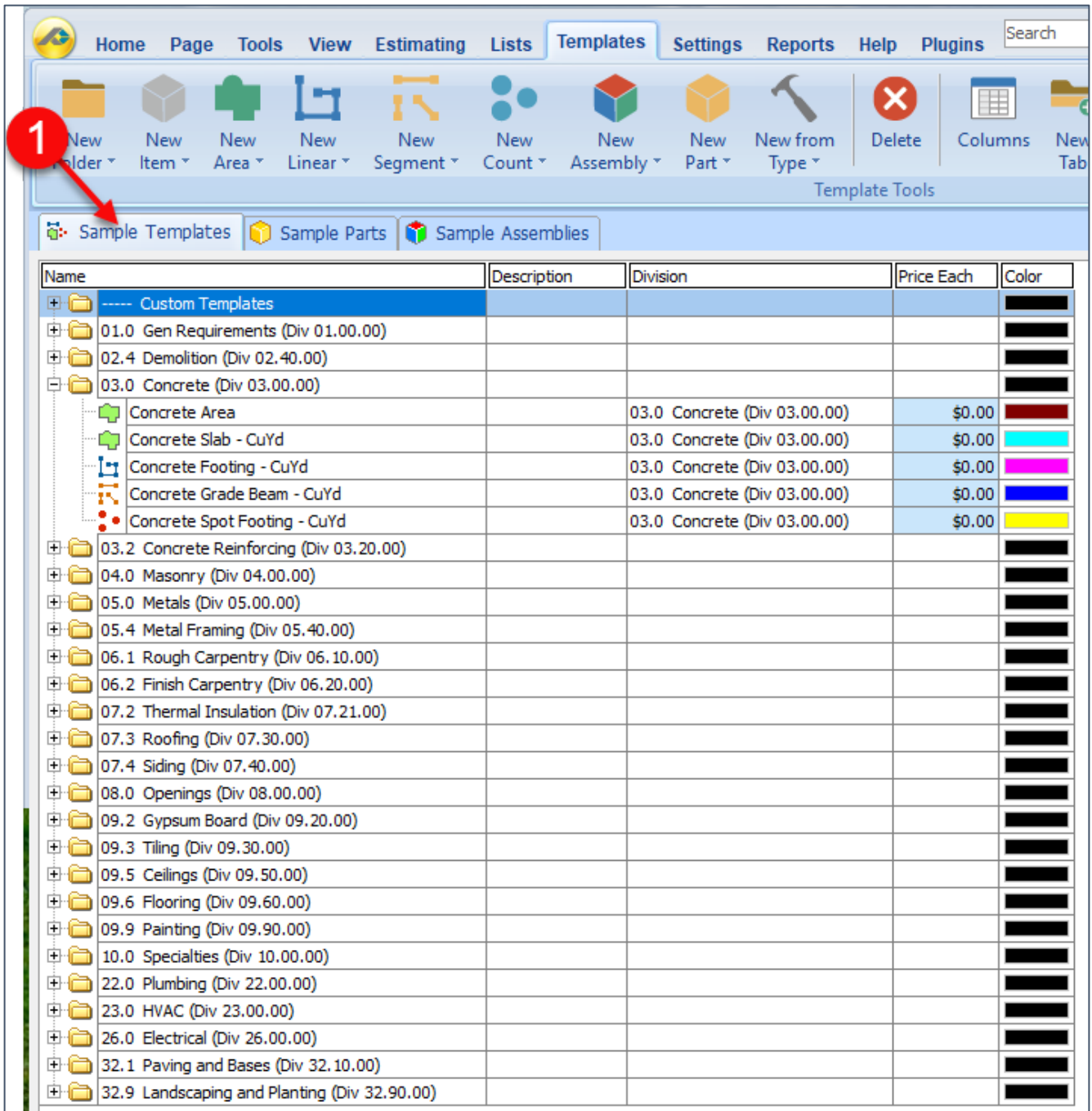

Figure 40-B

2. Figure 40-C shows the **Sample Parts**.

The screenshot shows a software interface with a menu bar (Home, Page, Tools, View, Estimating, Lists, Templates, Settings, Reports, Help, Plugins) and a toolbar. The 'Sample Parts' tab is active. A red circle with the number '2' highlights the 'New Part' button in the toolbar. Below the toolbar is a table with the following data:

Name	Description	Price Each	Color	Division
Material Parts (Drag-Drop)				
01.0 Gen Requirements (Div 01.00.00)				
03.0 Concrete (Div 03.00.00)				
Concrete (Area Takeoffs)				
Pea Gravel (priced per CU YD)	Pea Gravel - 3500 LBS per CuY	0		03.0 Concrete (Div 03.00.00)
Concrete Slab (priced per CU YD)	4000 PSI, 4" Thick	0		03.0 Concrete (Div 03.00.00)
Aggregate Base (priced per CU YD)	Aggregate Base - 3500 LBS per	0		03.0 Concrete (Div 03.00.00)
Aggregate Base (priced by Tons)	Aggregate Base - 3800 LBS per	0		03.0 Concrete (Div 03.00.00)
Concrete (Count Takeoffs)				
Concrete (Linear/Segment Takeoffs)				
Concrete Parts (Manual Qty)				
03.2 Concrete Reinforcing (Div 03.20.00)				
04.0 Masonry (Div 04.00.00)				
05.0 Metals (Div 05.00.00)				
05.4 Metal Framing (Div 05.40.00)				
06.1 Rough Carpentry (Div 06.10.00)				
06.2 Finish Carpentry (Div 06.20.00)				
07.2 Thermal Insulation (Div 07.21.00)				
07.3 Roofing (Div 07.30.00)				
07.4 Siding (Div 07.40.00)				
08.0 Openings (Div 08.00.00)				
09.2 Gypsum Board (Div 09.20.00)				
09.3 Tiling (Div 09.30.00)				
09.5 Ceilings (Div 09.50.00)				
09.6 Flooring (Div 09.60.00)				
09.9 Painting (Div 09.90.00)				
10.0 Specialties (Div 10.00.00)				
22.0 Plumbing (Div 22.00.00)				
23.0 HVAC (Div 23.00.00)				
26.0 Electrical (Div 26.00.00)				
32.1 Paving and Bases (Div 32.10.00)				
32.9 Landscaping and Planting (Div 32.90.00)				
Equipment Parts (Drag-Drop)				
Labor Parts (Drag-Drop)				
Subcontract Parts (Drag-Drop)				

Figure 40-C

3. Figure 40-D shows the **Sample Assemblies**.

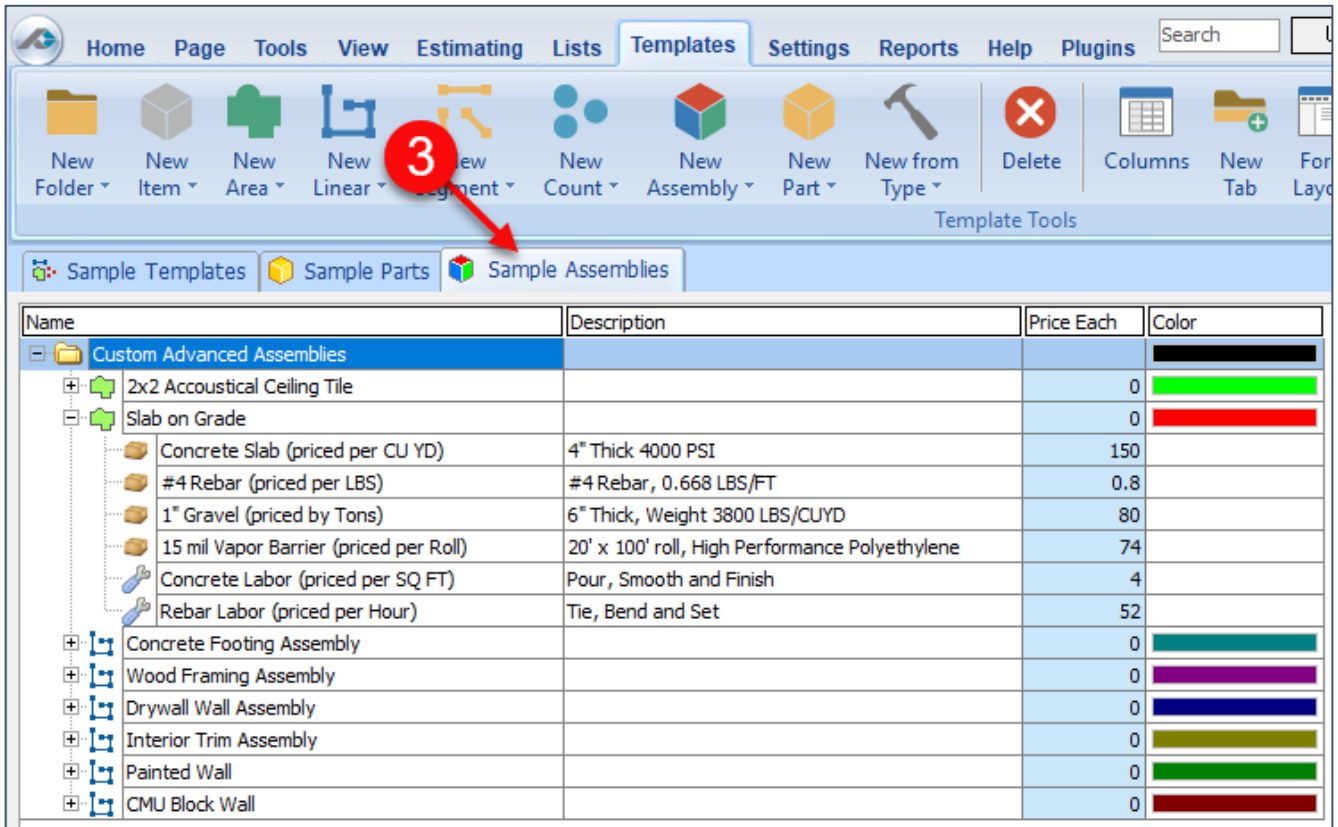

Figure 40-D

The display of these templates is controlled with two different ways. The first way is shown in Figure 40-E, which shows a drop-down menu that lists the available templates. Those that have boxes around them are displayed as a tab. Clicking on a template toggles the display of the box (and thus the display of the tab) on or off.

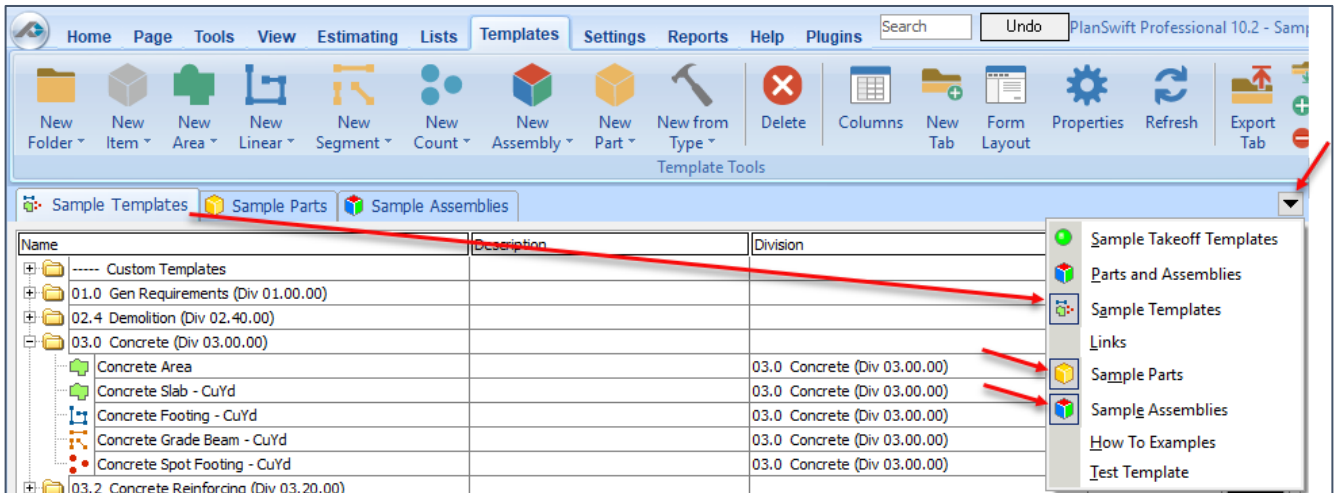

Figure 40-E

The second way is by right-clicking the tab itself (Fig. 40-F). This menu allows you to view the properties, create a new tab, delete the tab, export the tab, compile the tab, hide a tab, and display any hidden tabs.

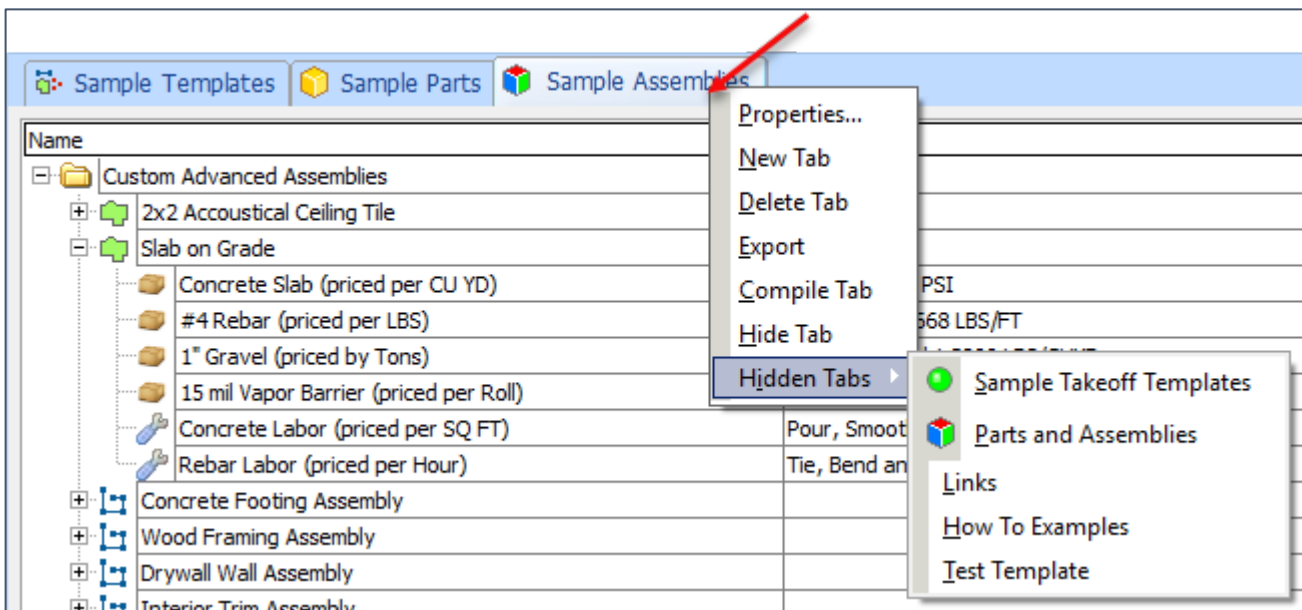

Figure 40-F

The same templates visible as tabs are also visible in the **Templates** window (Fig. 40-G). A drop-down menu allows you to select whether **Sample Templates**, **Sample Parts**, or **Sample Assemblies** are displayed in the **Templates** window. This window allows you to initiate takeoffs from it (turn on the digitizer) using any template listed by clicking on the green button left of the template and then performing the takeoff.

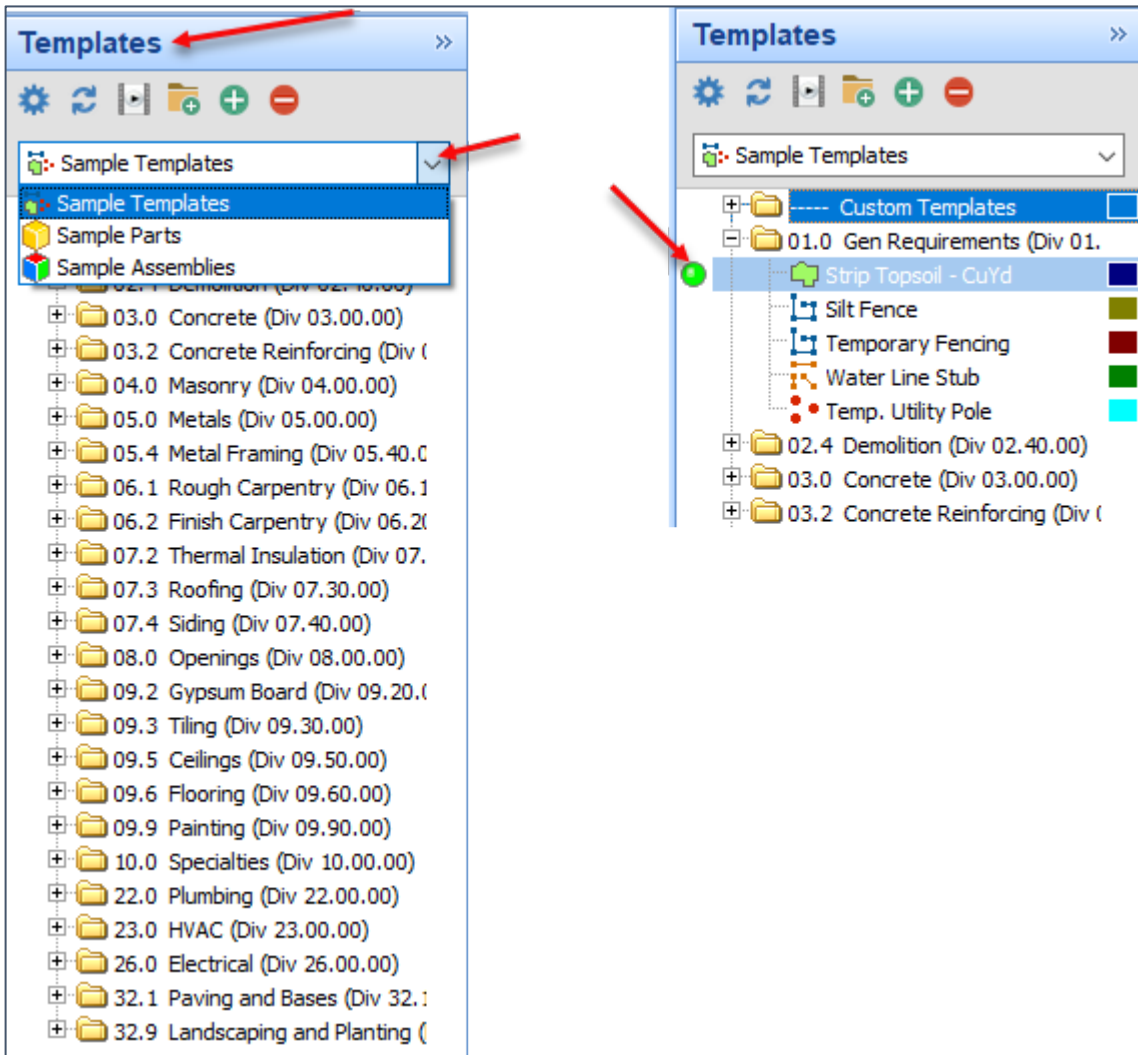

Figure 40-G

---

## Key Features of the Templates Tab

The **Templates** tab ribbon-bar provides tools to assist in creating, organizing, and modifying new takeoff item templates.

### Creating and Organizing Templates

The first nine of the **Template** tab buttons are “split buttons”, meaning they have two functions (Fig. 40-H). The top half of each of these eight buttons allows you to create new **Folders, Items, Areas, Linears, Segments, Counts, Assemblies, Parts, and Types**; the drop-down half of the buttons create each of the preceding items as **Sub-Items**. (Note that once items are created and then further modified, the items can be copied and pasted to save the user time in making further modifications, rather than “starting from scratch” with new items for each new template.)

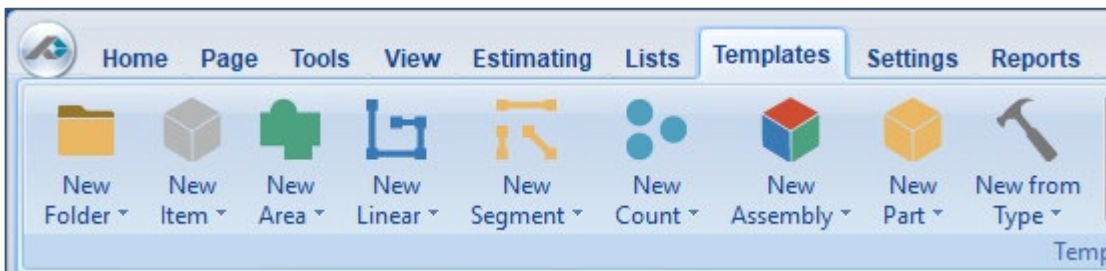

Figure 40-H

The top half of the **New from Type** button opens the **New from Type** window, which allows you to select a type for a new template (Fig. 40-I).

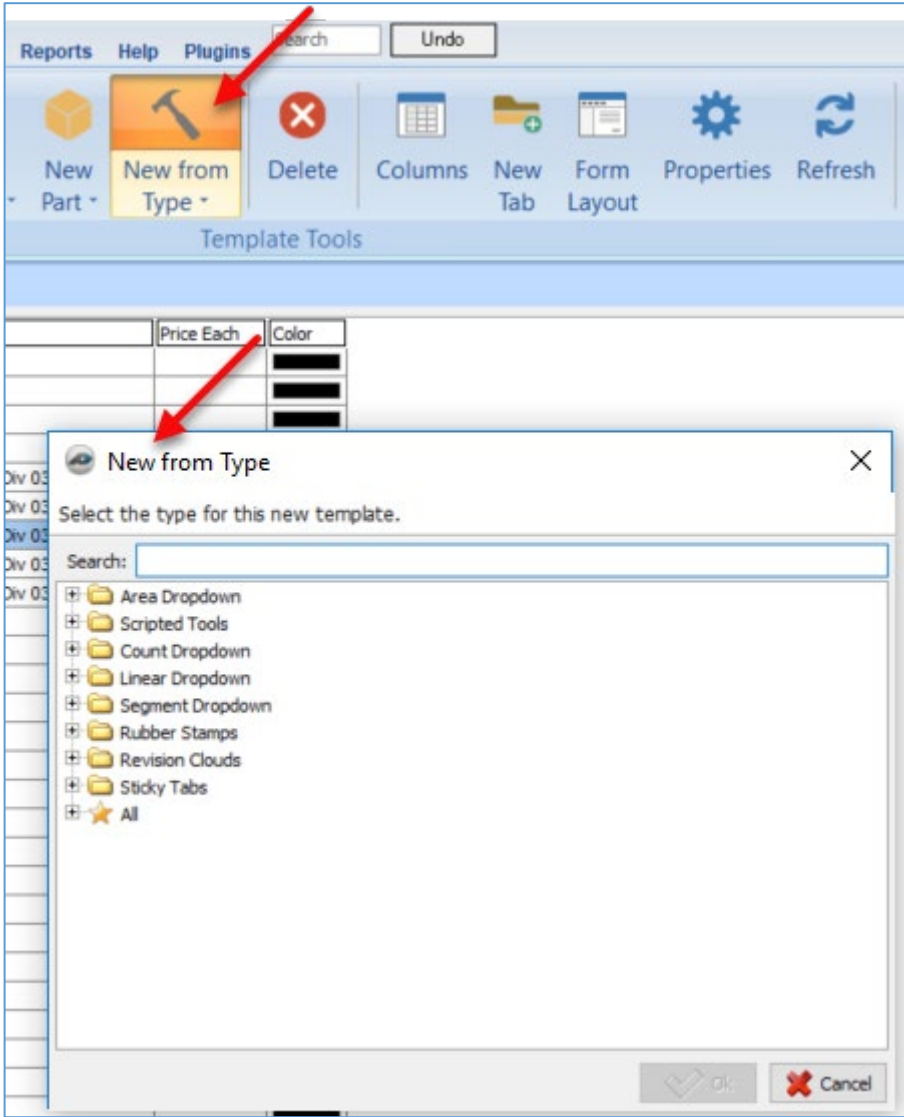

Figure 40-I

Advanced users can also turn on the **Types** tab from within the **Settings** tab (Fig. 40-J). (Caution: using and customizing **Types** is for advanced users. We highly recommend purchasing a [training package](#) for accelerated learning and faster customization.)

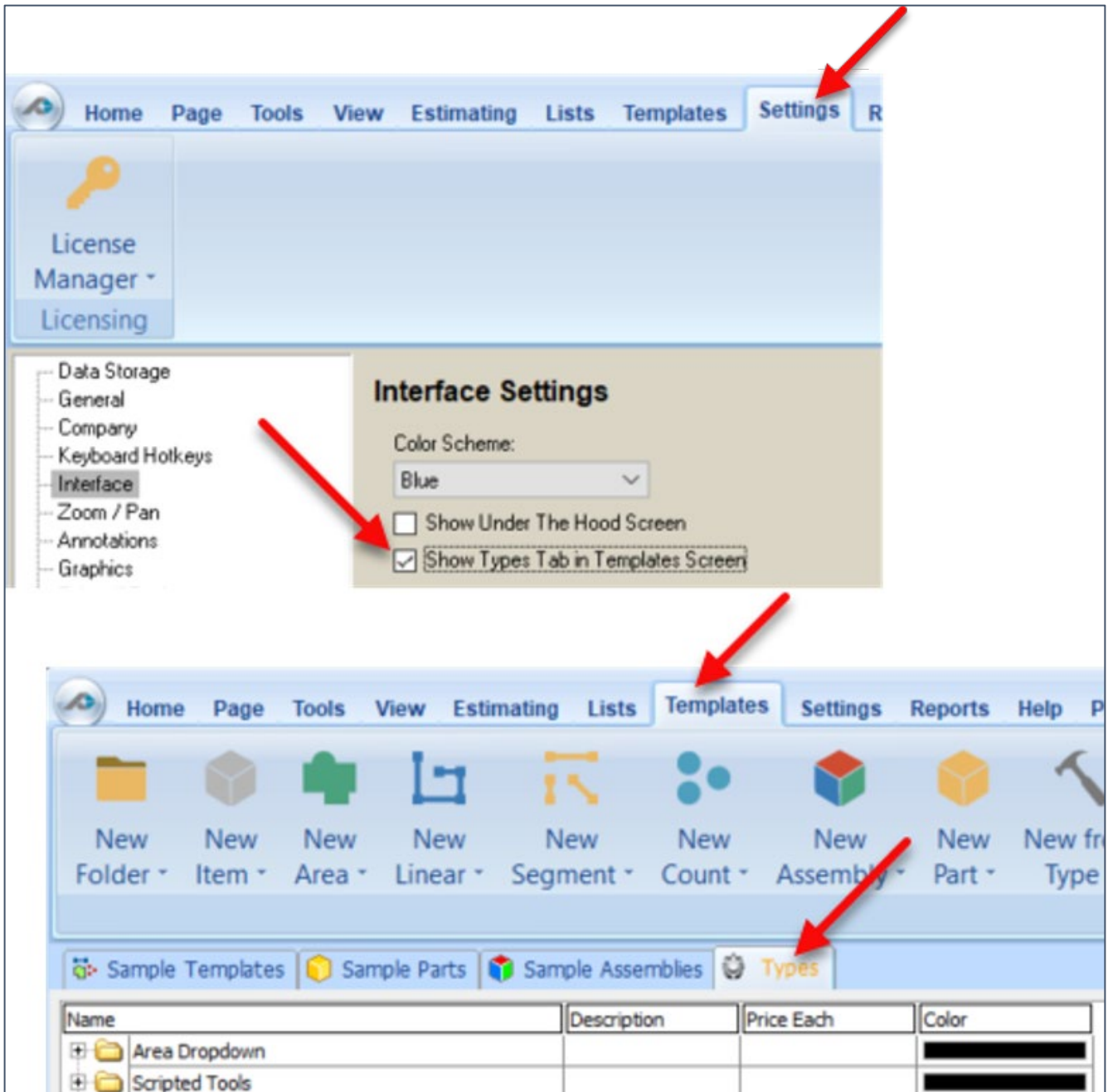

Figure 40-J



## Modifying Templates

The **Templates** tab ribbon-bar also provides tools to assist in modifying takeoff item templates (Fig. 40-K).

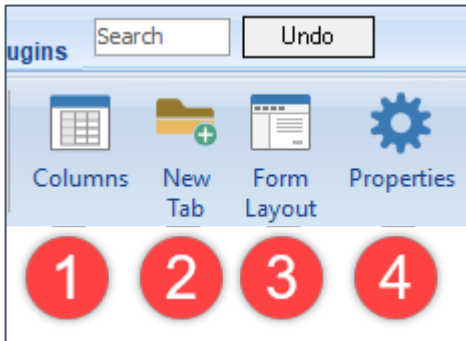

Figure 40-K

1. The **Columns** button on the **Templates** tab (Fig. 40-L) allows you to add rows or delete rows with the green (+) or red (X) buttons, select the **Data Type**, select whether the row should be **Visible**, select whether to **Show Units**, and to specify the **Format**.

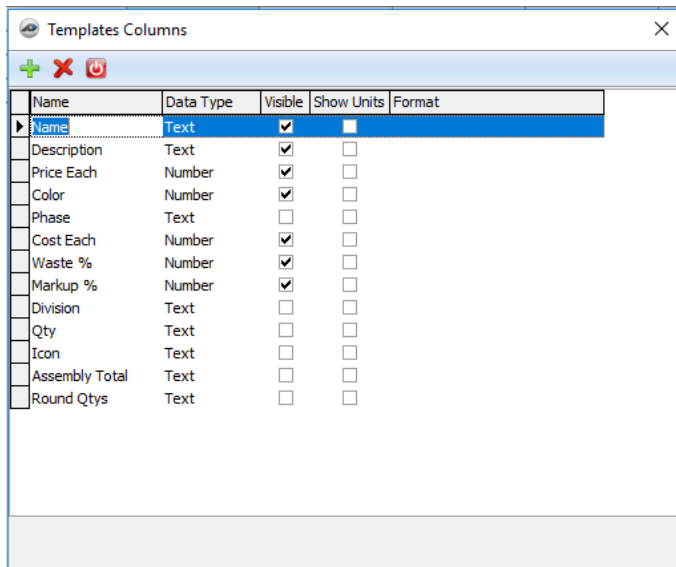

Figure 40-L

- 
2. The **New Tab** button creates a new template tab (Fig. 40-M). The storage location is set to **Local** by default. If you have set up other network drives within PlanSwift settings, then you can select a different storage location for the templates to be saved to.

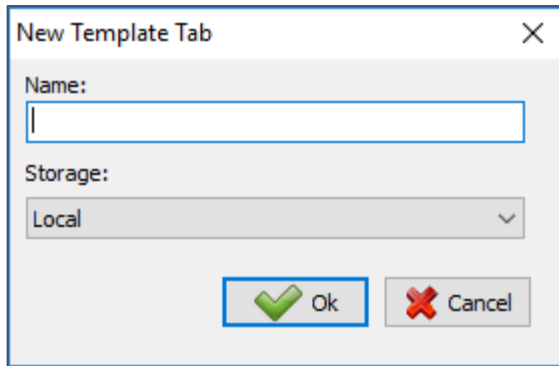

Figure 40-M

3. The **Form Layout** button allows you to layout the form for a template (Fig. 40-N).

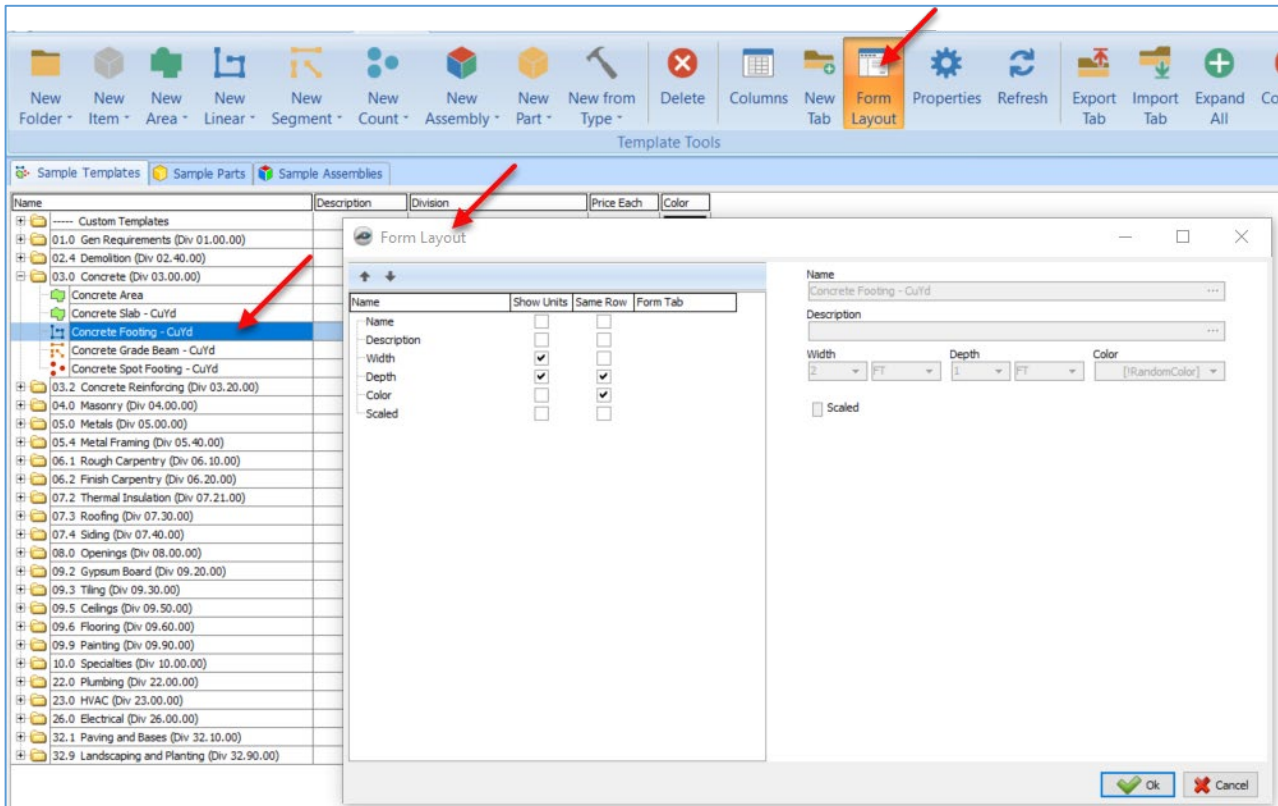

Figure 40-N

4. The **Properties** button displays the properties of the template. Each item in PlanSwift has its own properties window. Each property window includes three view options: **Form**, **Advanced**, and **Input**. The default for most items is the **Form** view. Figure 40-O shows the **Form** view, Figure 40-P shows the **Advanced** view, and Figure 40-Q shows the **Input** view.

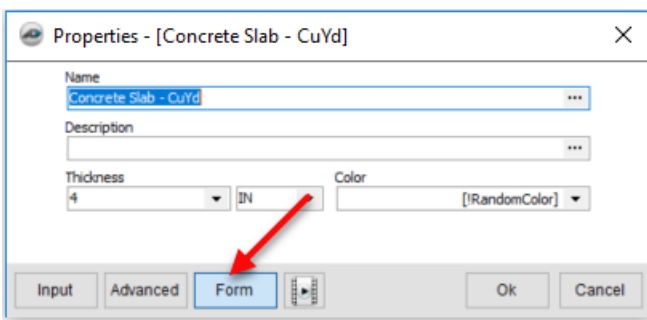

Figure 40-O

Properties - [Concrete Slab - CuYd]

Form Layout Events

Name	Formula	Input Units	Adjust	Result	Output Units
<b>Item</b>					
Type	Area			Area	
Name	Concrete Slab - CuYd			Concrete Slab - CuYd	
Description					
Item #					
<b>Estimating</b>					
Qty Formula	[Area] * ([Thickness] / 12) / 27 * ([Slope %] / 100 + 1)	CU YD		0.00	CU YD
Qty	[RoundUp([Qty Formula] * ([Waste %] / 100 + 1))] * ([Round Qtys]	CU YD		0.00	CU YD
Cost Total	[Qty] * [Cost Each]	\$		0.00	\$
Markup Each	[Cost Each] * ([Markup %] / 100)			0.00	
Slope %		%		0.00	%
Markup Total	[Qty] * [Markup Each]	\$		0.00	\$
Thickness	4	IN		4	IN
Price Each	[Cost Each] + [Markup Each]	\$		0.00	\$
Pitch	6	/12		6	/12
Waste %		%		0	%
Cost Each		\$		0.00	\$
Markup %	0	%		0.00	%
Price Total	[Qty] * [Price Each]	\$		0.00	\$
Multiply	1	Time(s)		1	Time(s)
Round Qtys	<input type="checkbox"/>			False	
Wall Height	0	FT		0	FT
Assembly Total	[sum(Price Total)] + [Price Total]	\$		0.00	\$
Assembly Unit Price	[Assembly Total] / [Qty]	\$		0.00	\$
<b>Fill</b>					
Color	[RandomColor]				
Transparency	<input type="text" value="0"/>			100.00	
<b>Takeoff Data</b>					
Volume	[Area] * [Depth]	CU FT		0.00	CU FT
Takeoff	[Qty]	CU YD		0.00	CU YD
Area	[Area]	SQ FT		0.00	SQ FT

Inheritance path: \_All\Item\Takeoff Item\Area\

Input **Advanced** Form Ok Cancel

Figure 40-P

Properties - [Concrete Slab - CuYd]

Name	Value	Units
<b>Concrete Slab - CuYd</b>		
Description		
Thickness	4	IN
Color	8,388,736.00	

Input **Advanced** Form Ok Cancel

Figure 40-Q

## Exporting and Importing

When initially installed, PlanSwift includes three tabs, **Sample Templates**, **Sample Parts**, and **Sample Assemblies**, where pre-built templates are stored.

Tabs can be created, deleted, hidden, redisplayed, exported, and imported. The **Export Tab** (see #1 of Fig. 40-R) exports the contents of the selected templates tab, allowing you to select where the data will be saved and to provide a name for the data (Fig. 40-S).

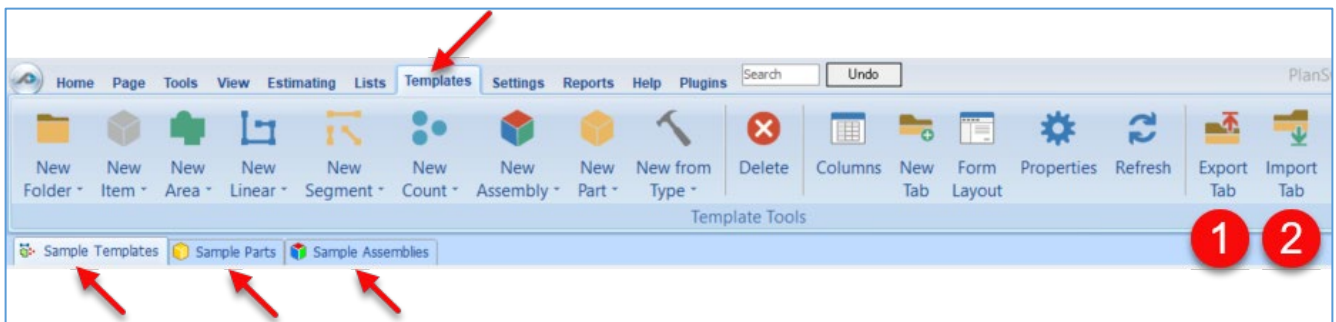

Figure 40-R

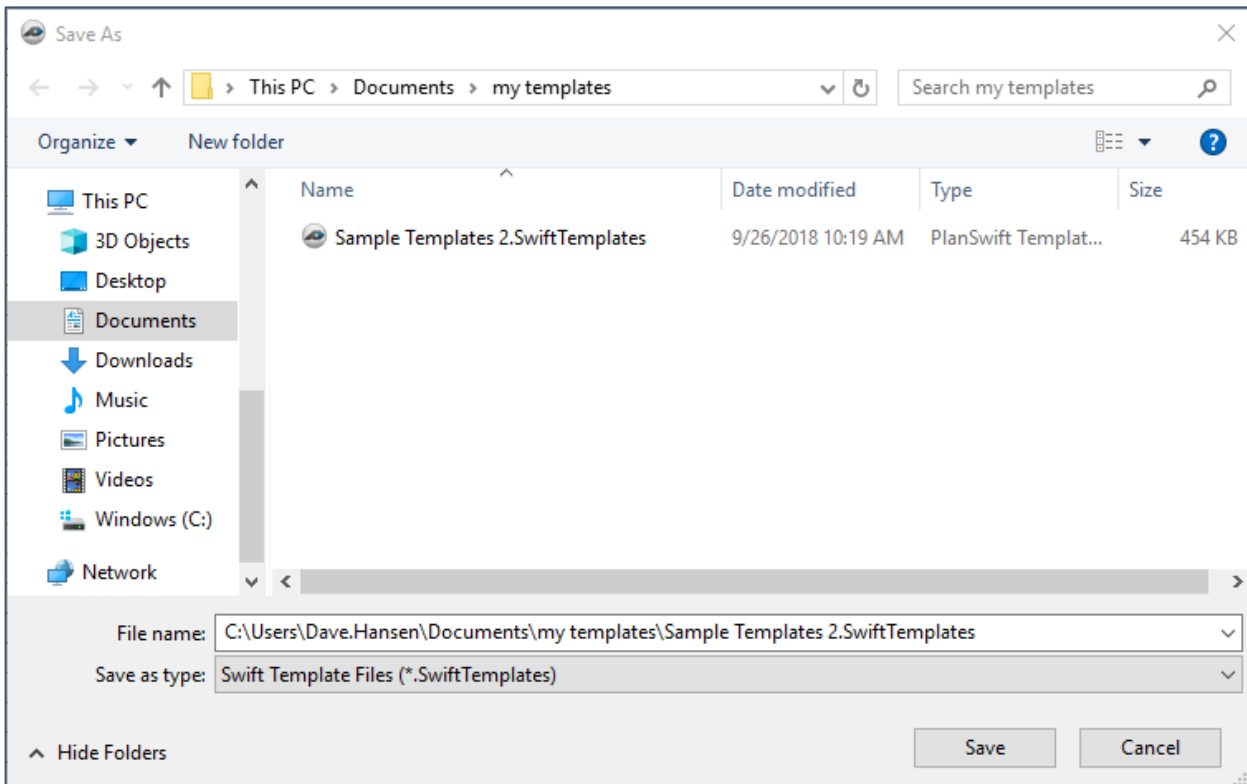

Figure 40-S

The **Import Tab** (see #2 of Fig. 40-R) imports a template that was previously saved or created, allowing you to select the name for the template (Fig. 40-T).

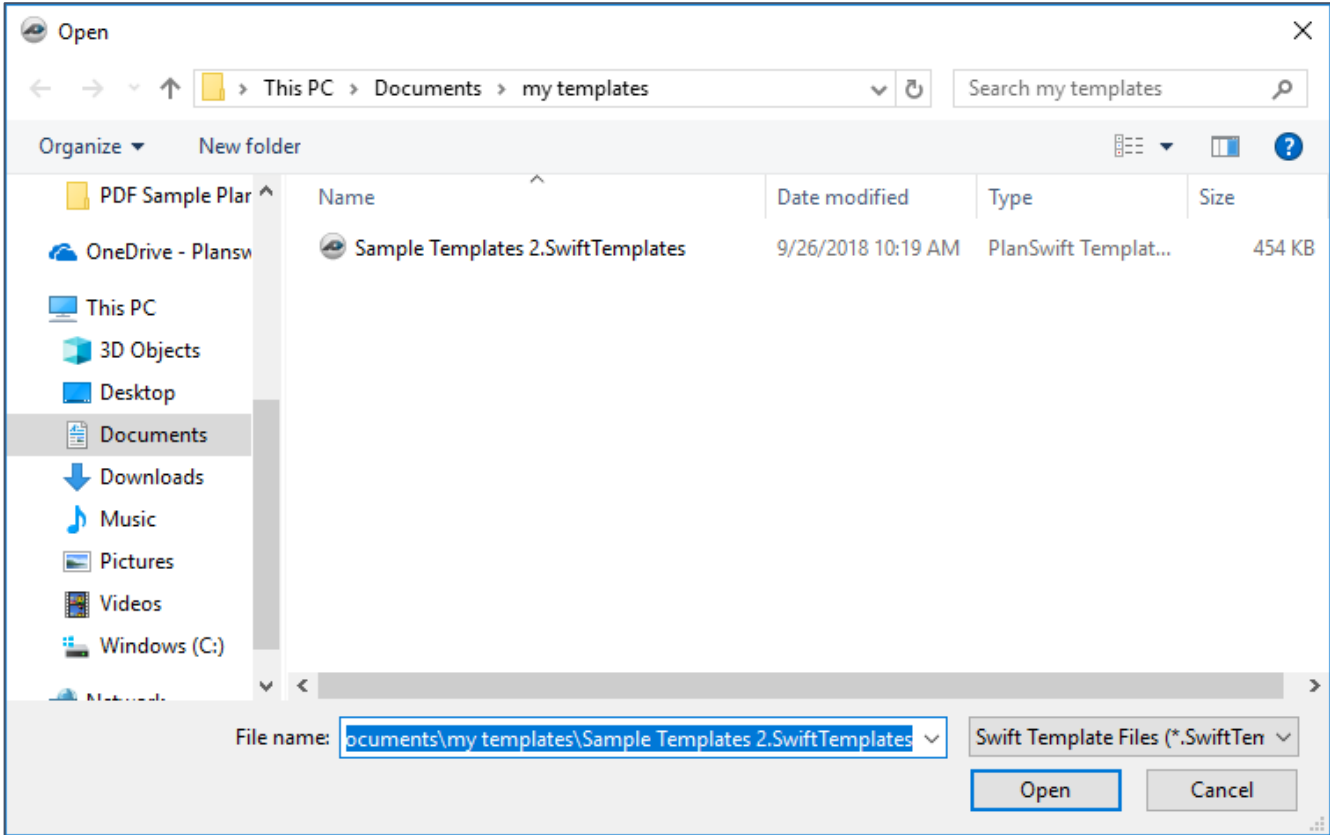

Figure 40-T

# Parts Overview

The instructions below will guide new users through the basics of copying and pasting parts and dragging and dropping parts. We highly recommend purchasing a [training package](#) for accelerated learning and faster customization.

## How to Copy and Paste Parts

Copying and pasting parts is handled similarly to copying and pasting an assembly. If, for instance, you want to move **Material 6** in **Area Takeoff Item Example 2** to **Area Takeoff Item Example 1** (as shown in Fig. 41-A), click on **Material 6 (#1)**, then click on copy (#2).

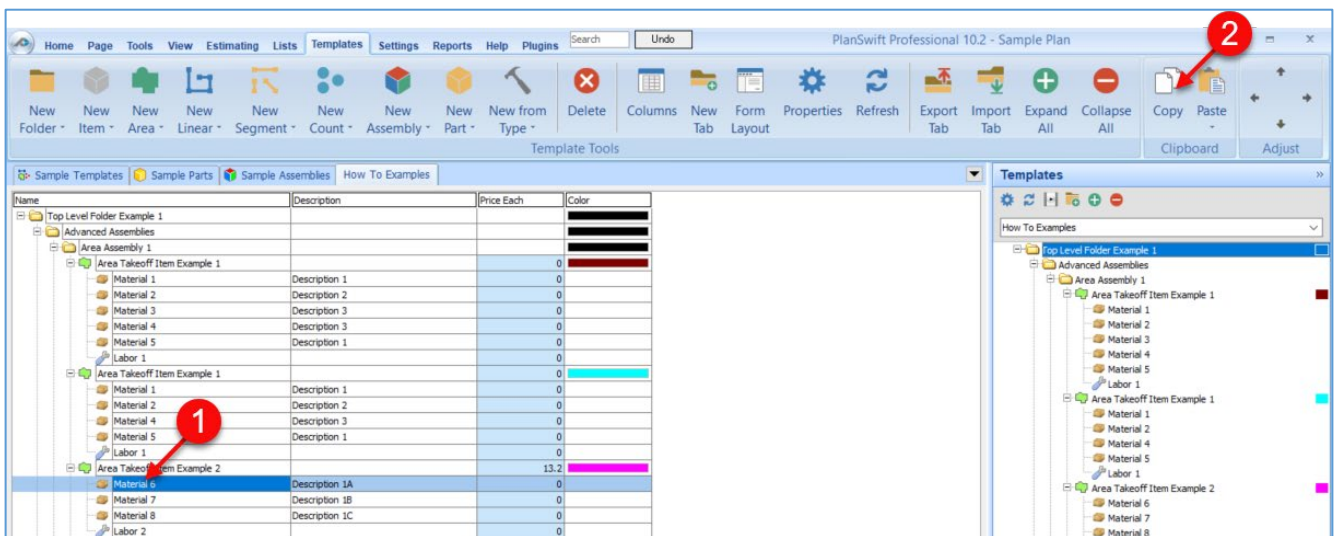

Figure 41-A

There are now two ways to paste the part. The first is to paste it at the same hierarchical level of a selected item, and the second is to paste it as a sub-item of a selected item. Figure 41-B shows the **Paste** button. Clicking on the top half of the button pastes the part at the same hierarchical level of a selected item. Clicking on the drop-down half of the button, then selecting **As Sub-Item** pastes the part as a sub-item of the selected item.

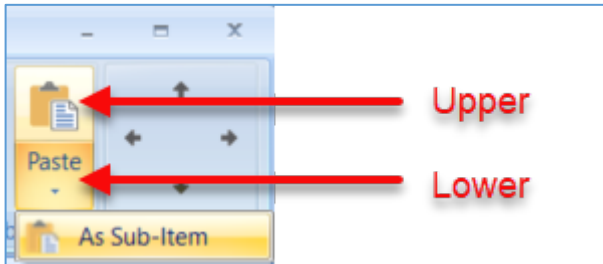

Figure 41-B

Click on **Area Takeoff Item Example 1**, (#1 of Fig. 41-C) then click on the top half of **Paste**. As shown in Figure 41-C, **Material 6** (#2) gets pasted at the same hierarchical level as **Area Takeoff Item Example 1** (#3).

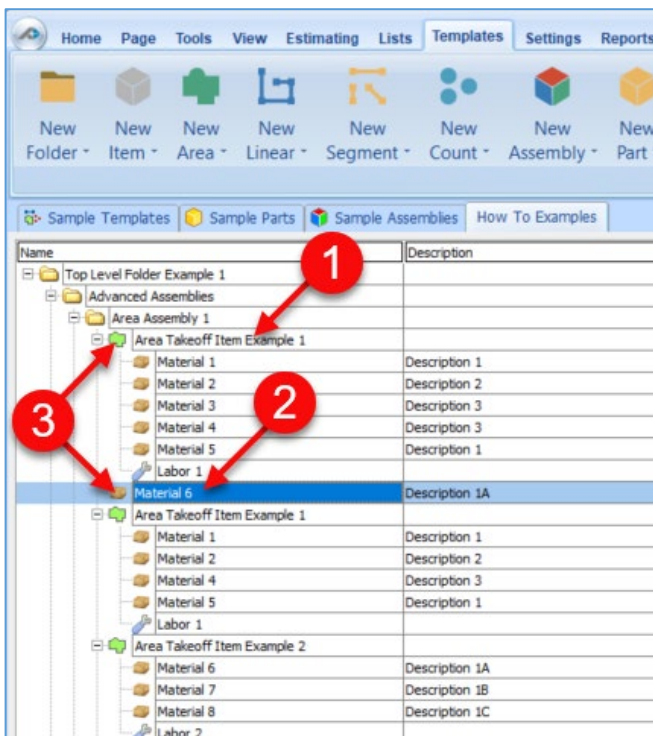

Figure 41-C



If you had selected the drop-down half of the **Paste** button, then Material 6 would be a sub-item of Area Takeoff Item Example 1. Figure 41-D shows Material 6 as a sub-item (#4).

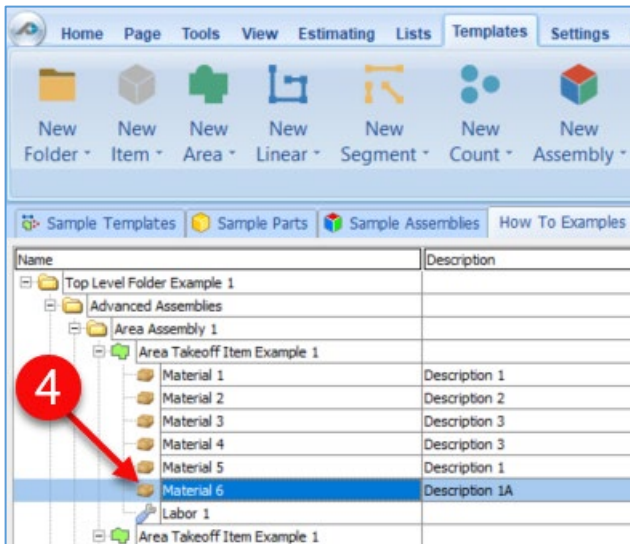

Figure 41-D

Another way to adjust the hierarchy of an item, such as **Material 6**, is to use the Main ribbon-bar arrow **Adjust** keys (Fig. 41-E). The left and right **Adjust** arrows move the item left and right (up or down) in the hierarchy, and the up and down **Adjust** arrows keys move the item higher and lower in the list of items.

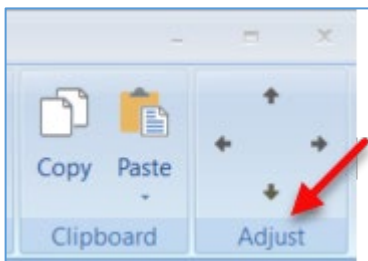

Figure 41-E

A shortcut to the **Copy** and **Paste** and **Paste as Sub-Item** selections is available with a right-click menu. Figure 41-F shows the **Copy**, **Paste**, and **Paste As Sub-Item** options on the right-click menu when **Material 6** is right-clicked on.

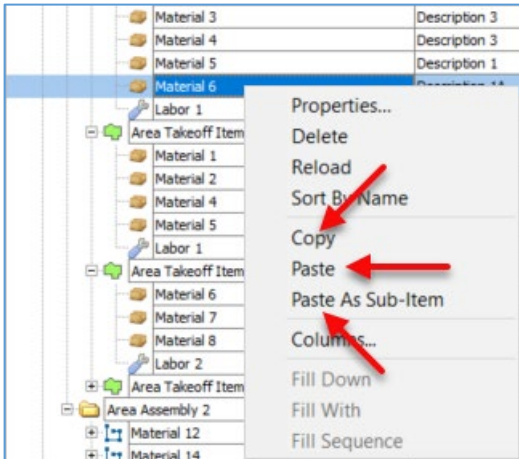

Figure 41-F

Double-clicking on **Material 6** allows you to change the name of the item and alter other properties of the item (Fig. 41-G). To change the name of **Material 6**, double-click on the **Material 6** name, type the new name and click on **Ok**.

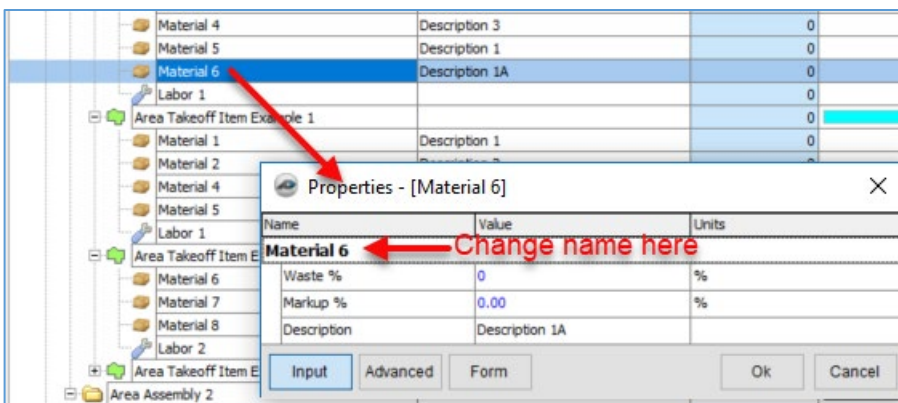

Figure 41-G

Figure 41-H shows **Material 6** renamed to **Material 6A**.

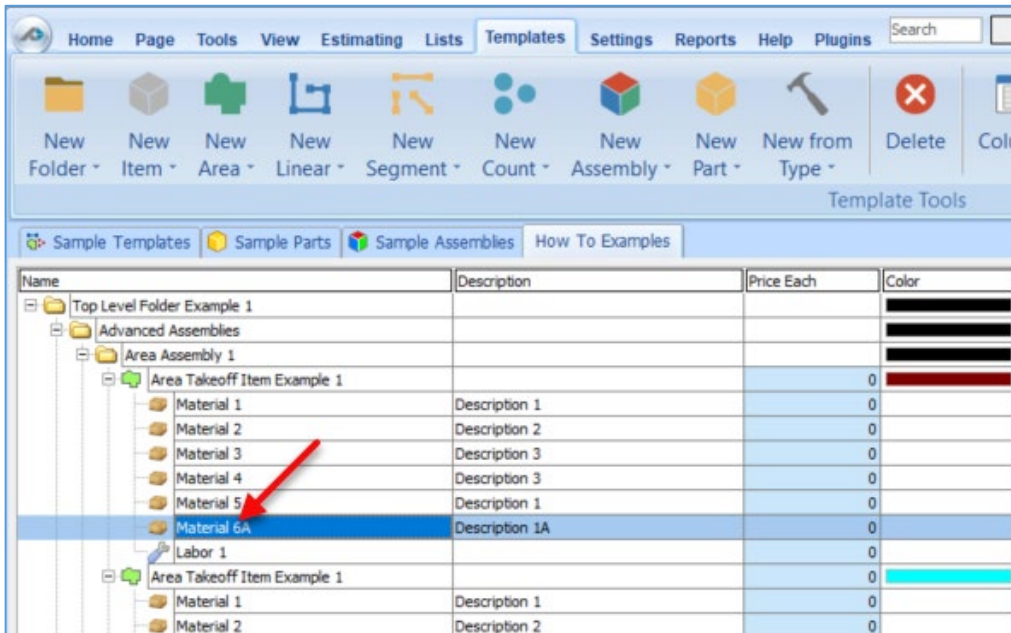

Figure 41-H

#### Disclaimer

Modifications that a user makes to templates, parts, and assemblies should always be tested and verified by that user to ensure quantities and calculations are accurate. PlanSwift cannot verify the accuracy of modifications made to templates, parts and assemblies by the user.

## How to Drag and Drop Parts

Parts may be dragged and dropped from one assembly to another assembly. If, for instance, you want to drag the **Material 8** item from **Area Takeoff Item Example 2** up to **Area Takeoff Item Example 1**, click on **Material 8** and drag it up to just below **Material 6A** (see Fig. 42-A) and release the mouse button.

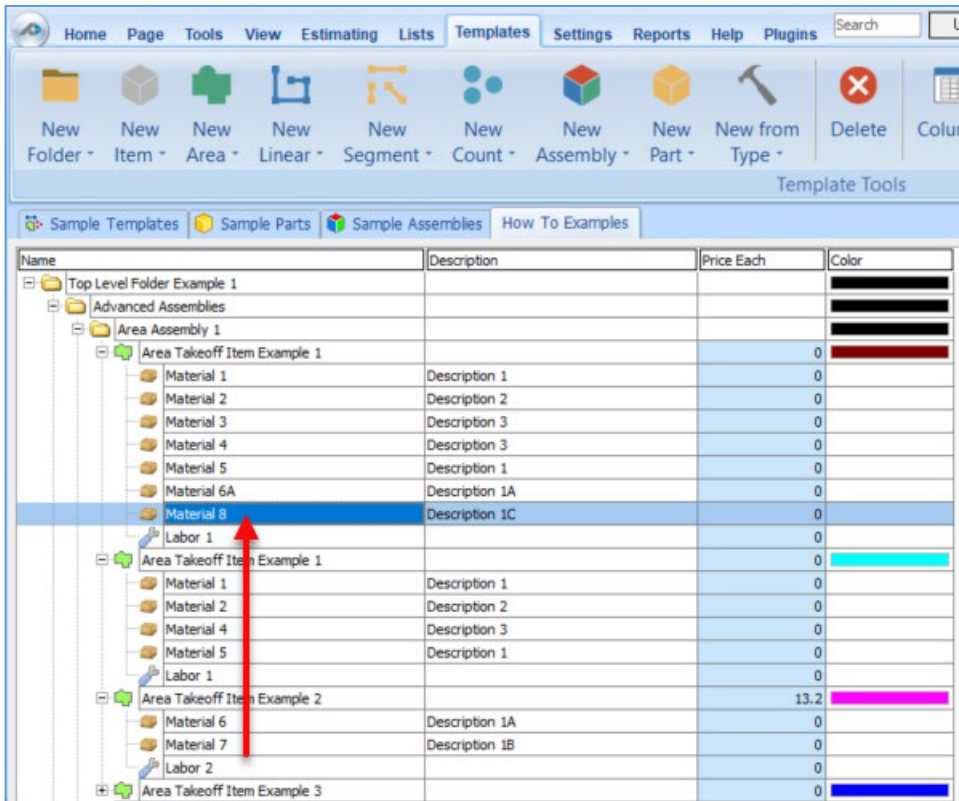

Figure 42-A

Notice that dragging the part this way *moves* the part from the **Example 2** assembly to the **Example 1** assembly, *not* leaving behind a copy.

The **Templates** sidebar window is a summarized view of everything in the **Templates Tab**. It is designed for easy dragging and dropping of parts and for quickly launching takeoff templates and assemblies.

Parts may be dragged over from the **Templates** sidebar window into the **Templates Tab** window; note that dragging any part from the **Templates** sidebar window makes a copy of it. If, for instance, you want a **Material 7** item added to **Area Takeoff Item**

**Example 1** as a sub-item, simply drag the **Material 7** from the right **Templates** sidebar window over on top of **Area Takeoff Item Example 1** label and release the mouse button. (Fig. 42-B).

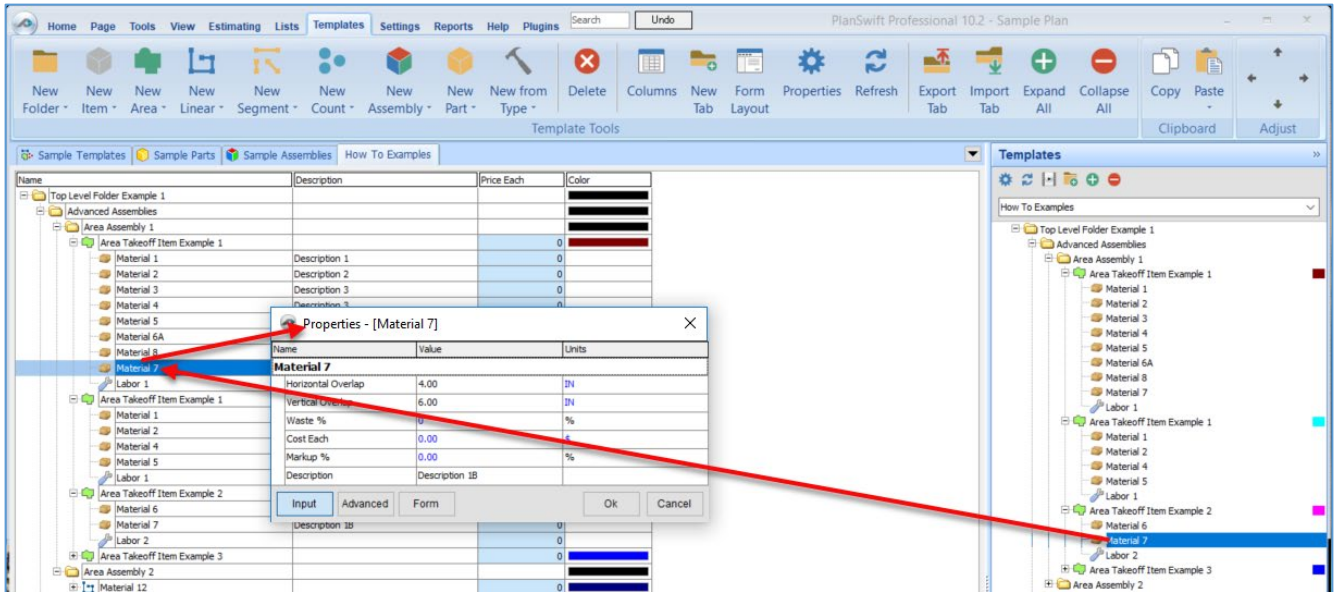

Figure 42-B

Figure 42-B shows the **Material 7** item in place after it was dropped on top of **Area Takeoff Item Example 1**. In addition, the **Properties – [Material 7]** window automatically opens, allowing the user to change any properties for **Material 7**. Click on **Ok** to close the **Properties – [Material 7]** window.

#### Disclaimer

Any modifications that a user makes to templates, parts, and assemblies should always be tested and verified by that user to ensure quantities and calculations are accurate. PlanSwift cannot verify the accuracy of modifications made to templates, parts and assemblies by the user.

# Assemblies Overview

The instructions below will guide new users through the basics of copying and pasting assemblies. We highly recommend purchasing a [training package](#) for accelerated learning and faster customization.

## How to Copy and Paste an Assembly

The purpose of copying and pasting an assembly is to allow the user to copy and then modify the assembly for later use. As an example, you may want two different assemblies: one might include a part, and another might have an alternative part or not include that part at all. By copying one assembly and then modifying and renaming the copy (for easy identification), you can have two different assemblies available, allowing for easier and faster takeoffs. Figure 43-A shows the **Templates Tab** (#1) and the **Area Takeoff Item Example 1** assembly (#2). If you want to add another assembly but with no **Material 3**, then you would click on the assembly you want to copy (#2), click on **Copy** (#3), and then click on **Paste** (#4).

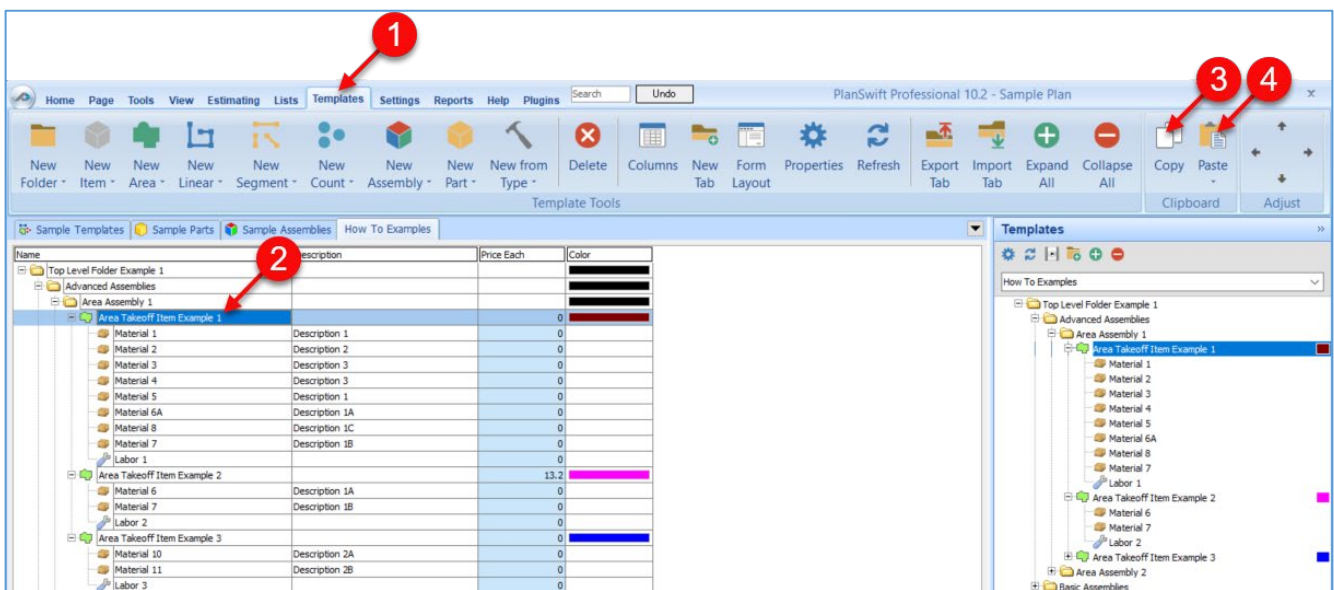

Figure 43-A

Figure 43-B shows the original (#1) and new **Area Takeoff Item Example 1** assembly (#2). To delete the **Material 3** (#3) from the newly created **Area Takeoff Item Example 1** assembly (#2), click on **Material 3** (#3), click on **Delete** (#4), and click on **OK** in the popup window to confirm the deletion.

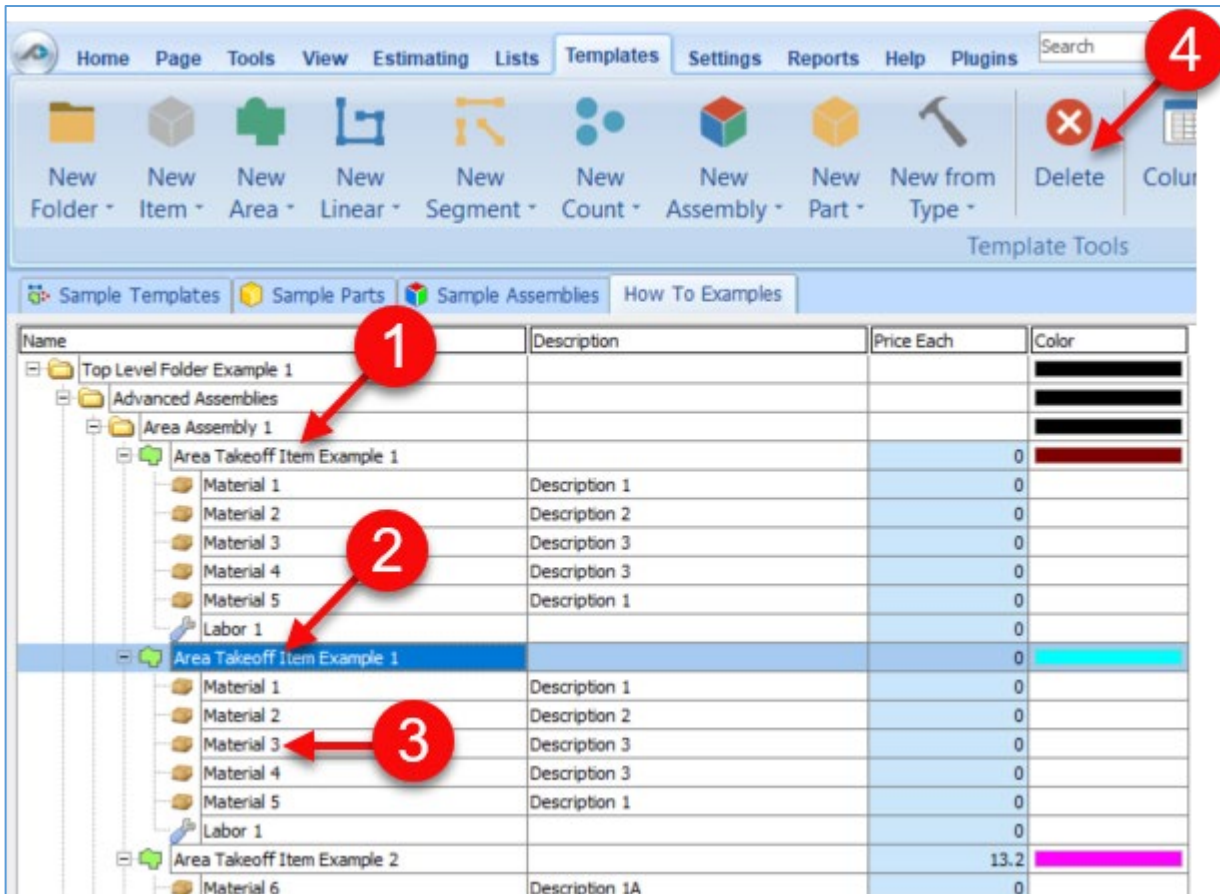

Figure 43-B

Figure 43-C now shows the two assemblies, one with (#1) and one without (#2) the **Material 3** item. You can now change the description of the duplicated **Area Takeoff Item Example 1** (#3) without the **Material 3** item by double-clicking the duplicate **Area Takeoff Item Example 1** (#3).

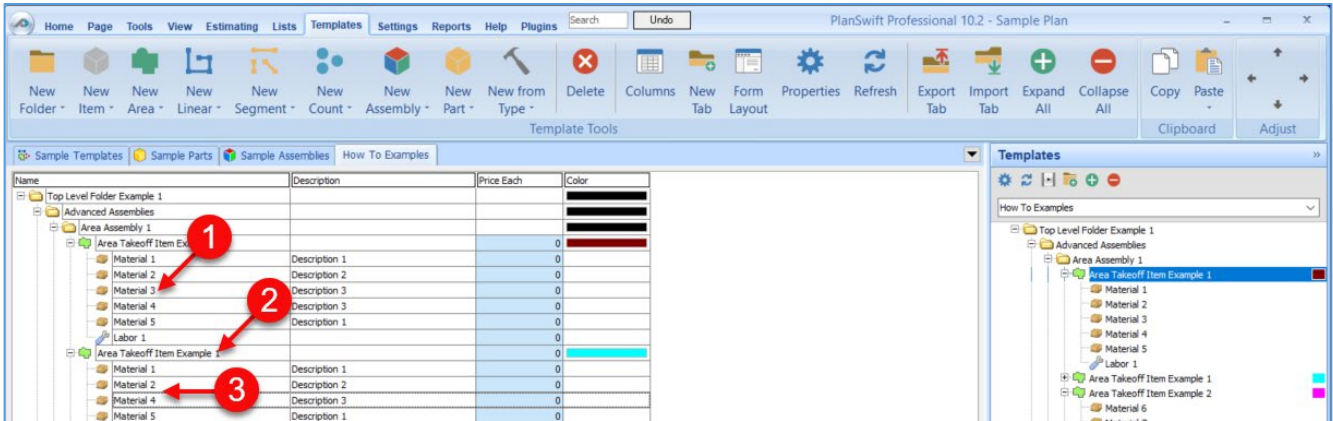

Figure 43-C

This opens the **Properties – [Area Takeoff Item Example 1]** window (Fig. 43-D) where you can change the assembly’s name to something like **Area Takeoff Item Example 1—No Material 3** to make it easier to identify.

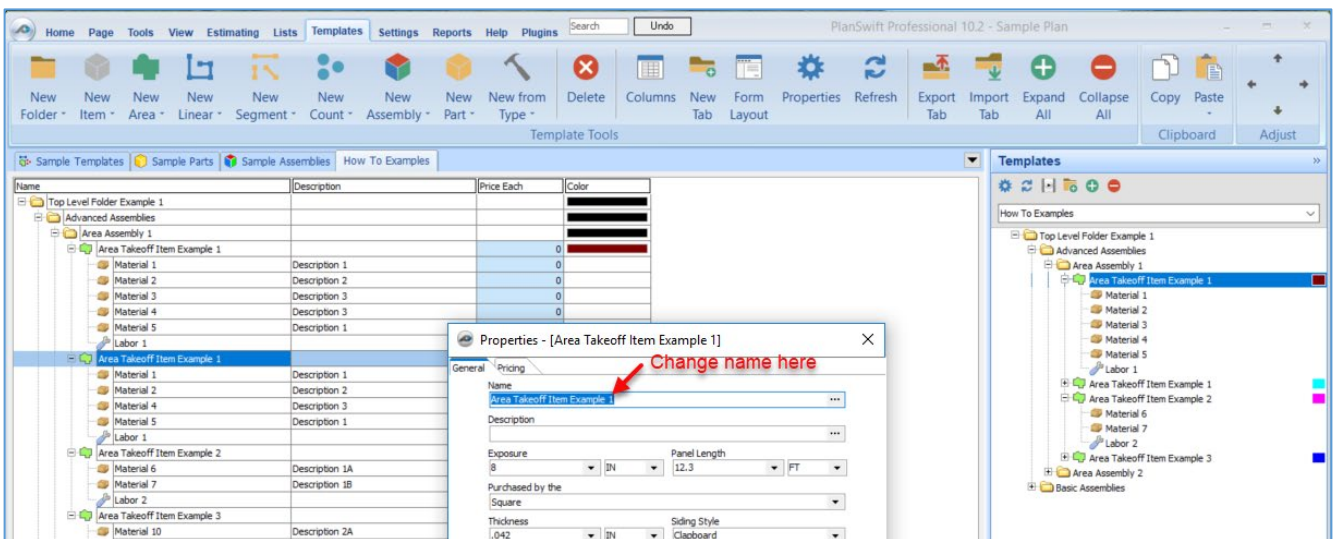

Figure 43-D



Click on **Ok** in the **Properties** window after you have entered the name. Figure 43-E shows the new name.

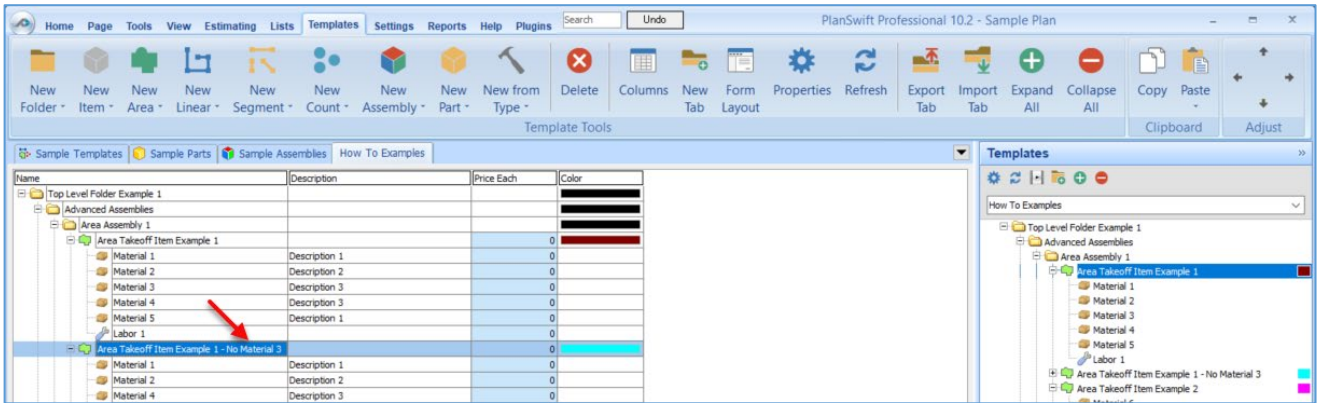

Figure 43-E

To perform a takeoff with the **Area Takeoff Item Example 1—No Material 3** assembly, go to the takeoff page, click on the green **Record Button** (see Fig. 43-F) in the **Templates** sidebar window, and then proceed to do your takeoff.

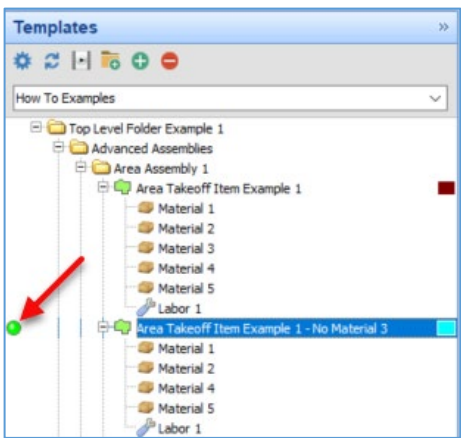

Figure 43-F

### Disclaimer

Any modifications that a user makes to templates, parts, and assemblies should always be tested and verified by that user to ensure quantities and calculations are accurate. PlanSwift cannot verify the accuracy of modifications made to templates, parts and assemblies by the user.

# Estimating Overview

The **Estimating** tab is a summary of the takeoffs for the current job. These takeoffs are displayed in a grid, which is called a layout. Several layouts are available, including a **Basic Layout** (Fig. 44-A) (this one is shown with a **Sections Filter**). Figure 44-B shows a **Default** estimating layout. Layouts can be modified by adding or removing columns. Each time a takeoff is performed, it adds a new row. Deleting a takeoff removes a row. Takeoff totals appear at the bottom of the layout. New layouts may also be created with the green “+” in the **Estimating Layouts** window (select an existing layout, click on the green +, give the layout a name, and the new layout will be based on the layout that was selected). PlanSwift provides a way to [export estimating data to Excel](#). Estimating data is also used for generating reports.

The screenshot displays the PlanSwift Professional 10.2 interface. The top menu bar includes Home, Page, Tools, View, Estimating, Lists, Templates, Settings, Reports, Help, and Plugins. The Estimating tab is active, showing a grid of takeoffs. The left sidebar, titled 'Estimating Layouts', contains a tree view with 'Basic Layout' selected. The main grid shows a hierarchical list of takeoffs with columns for Name, Description, Qty, Units, Cost Each, Cost Total, Markup %, Price Each, Price Total, and Color. A 'Sections Filter' dropdown is visible above the grid. At the bottom right, summary totals are shown: \$867.20, MAX=20.00, and \$63539.96.

Name	Description	Qty	Units	Cost Each	Cost Total	Markup %	Price Each	Price Total	Color
Sample Plan Takeoffs					\$0.00				
Lobby 101		900.85	SQ FT	\$0.00	0.00	0	\$0.00	\$0.00	
Installation Contract	Install only	1	EA	\$650.00	650.00	0	\$650.00	\$650.00	
Hardwood Flooring	40 SQ FT per box, 1/2" x 5" Oak Plank, Engineered	24.77	Box(s)	\$56.45	1398.27	0	\$56.45	\$1398.27	
Ceiling Grid	300 SQ FT per Box	4	Box(s)	\$32.10	128.40	20	\$38.52	\$154.08	
Acoustical Ceiling Tile	2' x 4' Tiles	124	EA	\$2.20	272.80	20	\$2.64	\$327.36	
Install Ceiling Grid and Tiles		900.85	SQ FT	\$0.45	405.38	0	\$0.45	\$405.38	
Section		900.85	SQ FT						
Residential Plan Takeoffs									
New Area		0	SQ FT	\$0.00	0.00	0	\$0.00	\$0.00	
Three-car garage		0	SQ FT	\$0.00	0.00	0	\$0.00	\$0.00	
Exterior Trim	Drp Edge	109.9	FT	\$0.00	0.00	0	\$0.00	\$0.00	
Section		81.17	FT						
Section		14.46	FT						
Section		3.25	FT						
Section		7.35	FT						
Section		3.67	FT						
Exterior Rock	River Rock	264.91	SQ FT	\$0.00	0.00	0	\$0.00	\$0.00	
Section		264.91	SQ FT						
Exterior Siding	Vinyl Siding	405.44	SQ FT	\$0.00	0.00	0	\$0.00	\$0.00	
Section		70.81	SQ FT						
Section		334.63	SQ FT						
Subtract Section		-1.94	SQ FT						
Subtract Section		-1.99	SQ FT						
Restrooms	Floor Tile	276.14	SQ FT	\$0.00	0.00	0	\$0.00	\$0.00	
Section		132.69	SQ FT						
Label									
Section		143.45	SQ FT						
Label									
Game Room	Drywall Ceiling	627.59	SQ FT	\$0.00	0.00	0	\$0.00	\$0.00	
Offices	2x4 Acoustical Ceiling Tile	322.74	SQ FT	\$0.00	0.00	0	\$0.00	\$0.00	
Section		135.92	SQ FT						
Label									
Section		186.82	SQ FT						
Label									
Interior Doors	Solid Core	14	EA	\$0.00	0.00	0	\$0.00	\$0.00	
Conference Room	Carpet	505.54	SQ FT	\$0.00	0.00	0	\$0.00	\$0.00	
Section		505.54	SQ FT						
Label									
Exterior Walls	Typical Wood Framed Wall	266.08	FT	\$0.00	0.00	0	\$0.00	\$0.00	
Section		266.08	FT						
Interior Walls	Typical Metal Framed Wall	294.37	FT	\$0.00	0.00	0	\$0.00	\$0.00	
Section		49.52	FT						
					\$867.20		MAX=20.00	\$63539.96	

Figure 44-A

PlanSwift Professional 10.2 - Sample

Home Page Tools View **Estimating** Lists Templates Settings Reports Help Plugins Search Undo

New Folder New Item New Area New Linear New Segment New Count New Assembly New Part New From Type Delete Print Columns Filter Refresh Properties Expand All Collapse All Export To Excel

Estimate

**Estimating Layouts**

- PlanSwift Layouts
  - Basic Layout
  - Waste %
  - Round Qtys
  - Item #
  - Division
  - Assembly Total
  - Multiply and Location
  - Takeoff View
  - Wall Area
  - Qty and Qty 2
  - WBS
  - Takeoff Data
  - Default**
- PS Layouts
  - Waste %
  - Basic Layout
  - Takeoff View
  - Takeoff Data
  - Wall Area
  - Round Qtys
  - Multiply and Location
  - Qty and Qty 2

**Default**

Name	Description	Qty	Units	Cost Each	Markup %	Price Each	Price Total	Color
Sample Plan Takeoffs				\$0.00				
Lobby 101		900.85	SQ FT	\$0.00	0	0	\$0.00	
Installation Contract	Install only	1	EA	\$650.00	0	650	\$650.00	
Hardwood Flooring	40 SQ FT per box, 1/	24.77	Box(s)	\$56.45	0	56.45	\$1,398.27	
Ceiling Grid	300 SQ FT per Box	4	Box(s)	\$32.10	20	38.52	\$154.08	
Acoustical Ceiling Tile	2' x 4' Tiles	124	EA	\$2.20	20	2.64	\$327.36	
Install Ceiling Grid and Tiles		900.85	SQ FT	\$0.45	0	0.45	\$405.38	
Residential Plan Takeoffs								
New Area		0	SQ FT	\$0.00	0	0	\$0.00	
Three-car garage		0	SQ FT	\$0.00	0	0	\$0.00	
Exterior Trim	Drip Edge	109.9	FT	\$0.00	0	0	\$0.00	
Exterior Rock	River Rock	264.91	SQ FT	\$0.00	0	0	\$0.00	
Exterior Siding	Vinyl Siding	405.44	SQ FT	\$0.00	0	0	\$0.00	
Restrooms	Floor Tile	276.14	SQ FT	\$0.00	0	0	\$0.00	
Game Room	Drywall Ceiling	627.59	SQ FT	\$0.00	0	0	\$0.00	
Offices	2x4 Accoustical Ceilin	322.74	SQ FT	\$0.00	0	0	\$0.00	
Interior Doors	Solid Core	14	EA	\$0.00	0	0	\$0.00	
Conference Room	Carpet	505.54	SQ FT	\$0.00	0	0	\$0.00	
Exterior Walls	Typical Wood Framed	266.08	FT	\$0.00	0	0	\$0.00	
Interior Walls	Typical Metal Framed	294.37	FT	\$0.00	0	0	\$0.00	
Common Room	Hardwood Flooring	696.43	SQ FT	\$0.00	0	0	\$0.00	
Carpet Brown		0	SQ FT	\$0.00	0	0	\$0.00	

Figure 44-B

## Manipulating an Estimating Layout

Clicking on the **Columns** button on the **Estimating** tab ribbon-bar opens the **Estimating Columns** window (Fig. 44-C).

Clicking on the green “+” allows you to add a new column to the layout and give it a name. Clicking on the red “X” will remove a selected column from the layout.

The **Estimating Columns** window also allows you to see the **Data Type**, select whether the column is **Visible**, select whether the units are visible (**Show Units**), and view the **Format**. The red **Close** icon to the right of the red **X** closes the window.

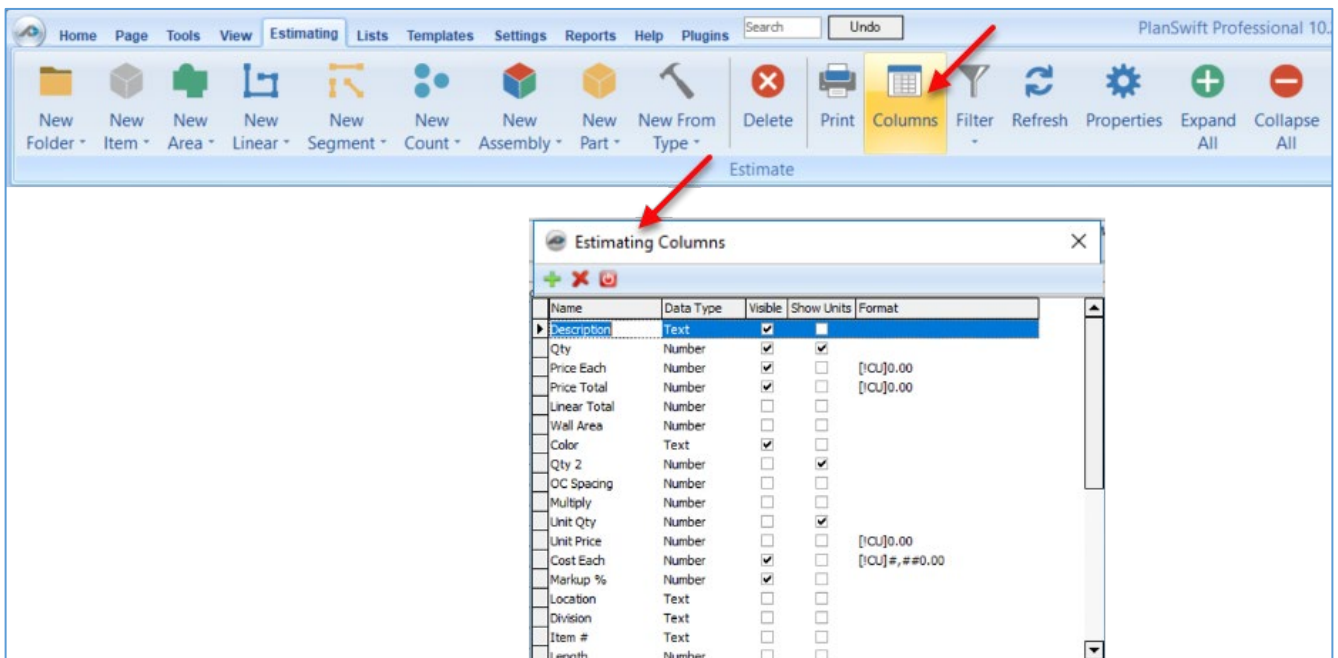

Figure 44-C

Rows can be moved up or down either by selecting, dragging, moving, and dropping the rows into folders or using the up and down **Adjust** arrows (Fig. 44-D). The left and right **Adjust** arrows will change a selected row's hierarchical order, or items can be dragged and dropped to a different parent item or folder on the layout.

The **Templates, Input** window allows for templates to be dragged and dropped onto takeoffs in the **Layout** window. Templates are covered in [Templates Overview](#).

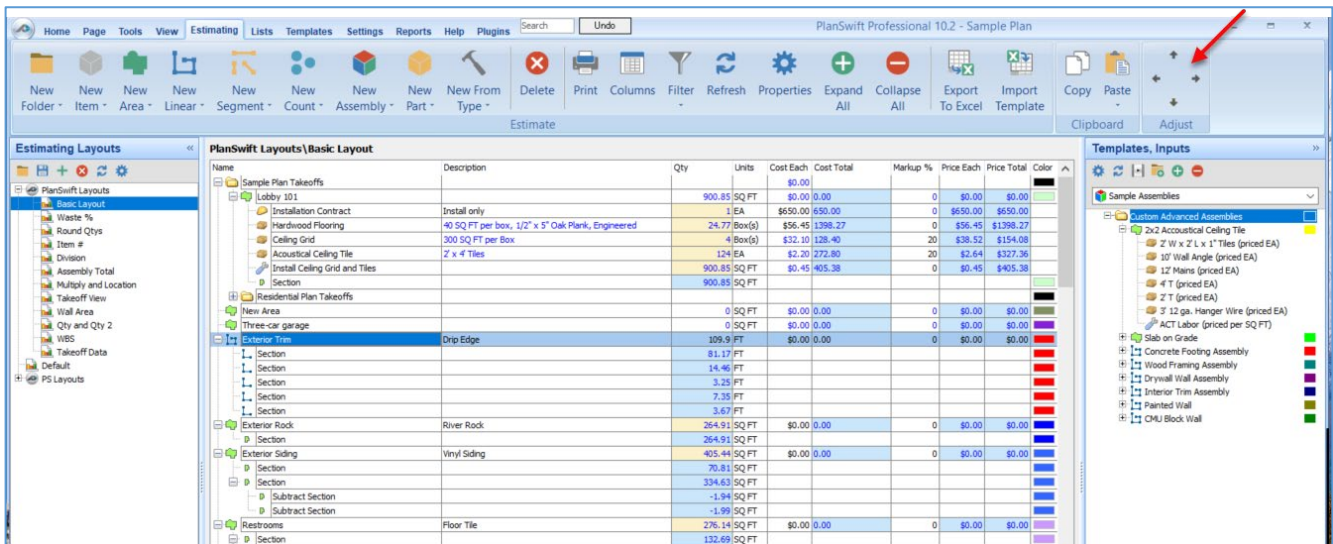

Figure 44-D

## Exporting Estimating Data to Excel

To export data to an Excel spreadsheet, simply click on the **Export to Excel** button on the **Estimating** tab (Fig. 44-E). This opens Excel, and the data is automatically exported into a spreadsheet. Figure 44-F shows the data from Fig. 44-E in an Excel spreadsheet.

Estimating Lists Templates Settings Reports Help Plugins Search Undo PlanSwift Professional 10.2 - Sample Plan

New Segment New Count New Assembly New Part New From Type Delete Print Columns Filter Refresh Properties Expand All Collapse All Export To Excel Import Template

Estimate

PlanSwift Layouts\Basic Layout

Name	Description	Qty	Units	Cost Each	Cost Total	Markup %	Price Each	Price Total	Color
Sample Plan Takeoffs				\$0.00					
Lobby 101		900.85	SQ FT	\$0.00	0.00	0	\$0.00	\$0.00	
Installation Contract	Install only	1	EA	\$650.00	650.00	0	\$650.00	\$650.00	
Hardwood Flooring	40 SQ FT per box, 1/2" x 5" Oak Plank, Engineered	24.77	Box(s)	\$56.45	1398.27	0	\$56.45	\$1398.27	
Ceiling Grid	300 SQ FT per Box	4	Box(s)	\$32.10	128.40	20	\$38.52	\$154.08	
Acoustical Ceiling Tile	2' x 4' Tiles	124	EA	\$2.20	272.80	20	\$2.64	\$327.36	
Install Ceiling Grid and Tiles		900.85	SQ FT	\$0.45	405.38	0	\$0.45	\$405.38	
Section		900.85	SQ FT						
Residential Plan Takeoffs									
New Area		0	SQ FT	\$0.00	0.00	0	\$0.00	\$0.00	
Three-car garage		0	SQ FT	\$0.00	0.00	0	\$0.00	\$0.00	
Exterior Trim	Drip Edge	109.9	FT	\$0.00	0.00	0	\$0.00	\$0.00	
Exterior Rock	River Rock	264.91	SQ FT	\$0.00	0.00	0	\$0.00	\$0.00	
Exterior Siding	Vinyl Siding	405.44	SQ FT	\$0.00	0.00	0	\$0.00	\$0.00	
Restrooms	Floor Tile	276.14	SQ FT	\$0.00	0.00	0	\$0.00	\$0.00	
Game Room	Drywall Ceiling	627.59	SQ FT	\$0.00	0.00	0	\$0.00	\$0.00	
Offices	2x4 Acoustical Ceiling Tile	322.74	SQ FT	\$0.00	0.00	0	\$0.00	\$0.00	
Interior Doors	Solid Core	14	EA	\$0.00	0.00	0	\$0.00	\$0.00	
Conference Room	Carpet	505.54	SQ FT	\$0.00	0.00	0	\$0.00	\$0.00	
Exterior Walls	Typical Wood Framed Wall	266.08	FT	\$0.00	0.00	0	\$0.00	\$0.00	
Interior Walls	Typical Metal Framed Wall	294.37	FT	\$0.00	0.00	0	\$0.00	\$0.00	
Common Room	Hardwood Flooring	696.43	SQ FT	\$0.00	0.00	0	\$0.00	\$0.00	
Carpet Brown		0	SQ FT	\$0.00	0.00	0	\$0.00	\$0.00	

Figure 44-E

AutoSave Off Sheet1 - Excel Dave Hansen

File Home Insert Page Layout Formulas Data Review View Help Acrobat PlanSwift Tell me what you want to do

Clipboard Font Alignment Number Styles Cells

A1	Name	Description	Qty	Units	Cost Each	Cost Total	Markup %	Price Each	Price Total	Color
2	Sample Plan Takeoffs				0					
3	Lobby 101		900.85	SQ FT	0	0	0	0	0	
4	Installation Contract	Install only	1	EA	650	650	0	650	650	
5	Hardwood Flooring	40 SQ FT per box, 1/2" x 5" Oak Plank, Engineered	24.77	Box(s)	56.45	1398.27	0	56.45	1398.27	
6	Ceiling Grid	300 SQ FT per Box	4	Box(s)	32.1	128.4	20	38.52	154.08	
7	Acoustical Ceiling Tile	2' x 4' Tiles	124	EA	2.2	272.8	20	2.64	327.36	
8	Install Ceiling Grid and Tiles		900.85	SQ FT	0.45	405.38	0	0.45	405.38	
9	Section		900.85	SQ FT						
10	Residential Plan Takeoffs									
11	New Area		0	SQ FT	0	0	0	0	0	
12	Three-car garage		0	SQ FT	0	0	0	0	0	
13	Exterior Trim	Drip Edge	109.9	FT	0	0	0	0	0	
14	Exterior Rock	River Rock	264.91	SQ FT	0	0	0	0	0	
15	Exterior Siding	Vinyl Siding	405.44	SQ FT	0	0	0	0	0	
16	Restrooms	Floor Tile	276.14	SQ FT	0	0	0	0	0	
17	Game Room	Drywall Ceiling	627.59	SQ FT	0	0	0	0	0	
18	Offices	2x4 Acoustical Ceiling Tile	322.74	SQ FT	0	0	0	0	0	
19	Interior Doors	Solid Core	14	EA	0	0	0	0	0	
20	Conference Room	Carpet	505.54	SQ FT	0	0	0	0	0	
21	Exterior Walls	Typical Wood Framed Wall	266.08	FT	0	0	0	0	0	
22	Interior Walls	Typical Metal Framed Wall	294.37	FT	0	0	0	0	0	
23	Common Room	Hardwood Flooring	696.43	SQ FT	0	0	0	0	0	
24	Carpet Brown		0	SQ FT	0	0	0	0	0	

Figure 44-F

---

## Reports Overview

The **Reports** tab provides a means to generate and organize reports using estimating data from the **Estimating** tab. Reports are used to group, sort, filter, and “dress up” the estimating data for a nicer presentation. PlanSwift provides both a basic report engine and a **Report Designer** engine that allows for greater customization and “dressing up”.

The basic report engine utilizes several key features to refine what is included in the reports and how the reports are displayed (including **Customize, Report Settings, Columns, and Page Setup**).

The **Report Designer** engine is built on top of the **Fast Reports** engine and is not shown on the ribbon-bar by default. All **Report Designer** reports are built on top of basic reports.

# Basic Report Engine

Figure 45-A shows a basic report using the same estimating data as shown in Figure 44-A. This report is filtering the estimating data to show **All Items (by Type, by Folder)** in the **Grid View**.

The screenshot displays the PlanSwift Professional 10.2 software interface. The main window shows a report titled "9.0 Reports\Reports for ALL Items\All Items (by Type, by Folder)". The report is displayed in Grid View, showing a list of items with columns for Name, Description, Qty, Units, Cost Each, Markup %, Price Each, Price Total, and Division. The report is filtered to show "All Items (by Type, by Folder)".

Type	Name	Description	Qty	Units	Cost Each	Markup %	Price Each	Price Total	Division
Folder	Type : Area (SUM=8099.80, \$91,422.95)								
Folder	Sample Plan Takeoffs (SUM=900.85, \$12,945.21)								
	Lobby 101		900.85	SQ FT	\$12.50	15	\$14.37	\$12,945.21	
Folder	Takeoff (SUM=7198.95, \$78,477.74)								
	Vent		8.89	SQ FT	\$0.00	0	\$0.00	\$0.00	
	Roof Area		3794.26	SQ FT	\$3.20	15	\$3.68	\$13,962.88	
	Restrooms	Floor Tile	276.14	SQ FT	\$15.20	15	\$17.48	\$4,826.93	
	Rest Room Tile		269.85	SQ FT	\$12.78	15	\$14.70	\$3,966.79	
	Offices	2x4 Accoustical Ceiling Tile	322.74	SQ FT	\$20.00	15	\$23.00	\$7,423.02	
	Game Room	Drywall Ceiling	627.59	SQ FT	\$10.90	15	\$12.53	\$7,863.70	
	Exterior Siding	Vinyl Siding	405.44	SQ FT	\$11.25	15	\$12.94	\$5,246.39	
	Exterior Rock	River Rock	264.91	SQ FT	\$30.00	15	\$34.50	\$9,139.40	
	Ducting		27.16	SQ FT	\$0.00	0	\$0.00	\$0.00	
	Conference Room	Carpet	505.54	SQ FT	\$9.00	15	\$10.35	\$5,232.34	
	Common Room	Hardwood Flooring	696.43	SQ FT	\$25.99	15	\$29.89	\$20,816.29	
	Area		0	SQ FT	\$0.00	0	\$0.00	\$0.00	
	Area		0	SQ FT	\$0.00	0	\$0.00	\$0.00	
	Area		0	SQ FT	\$0.00	0	\$0.00	\$0.00	
+	Type : Circle (SUM=0.00, \$0.00)								
+	Type : Count (SUM=14.00, \$1,932.00)								
+	Folder : Takeoff (SUM=14.00, \$1,932.00)								
	Interior Doors	Solid Core	14	EA	\$120.00	15	\$138.00	\$1,932.00	
+	Type : Joist Tool (SUM=0.00, \$0.00)								
+	Type : Labor (SUM=900.85, \$468.44)								
+	Type : Linear (SUM=1209.57, \$39,602.01)								
+	Folder : Takeoff (SUM=1209.57, \$39,602.01)								
	Linear		276.62	FT	\$0.00	0	\$0.00	\$0.00	
	Interior Walls	Typical Metal Framed Wall	294.37	FT	\$25.00	15	\$28.75	\$8,463.14	
	Footing		262.6	FT	\$38.00	15	\$43.70	\$11,475.62	
	Exterior Walls	Typical Wood Framed Wall	266.08	FT	\$56.00	15	\$64.40	\$17,135.55	
	Exterior Trim	Drip Edge	109.9	FT	\$20.00	15	\$23.00	\$2,527.70	
+	Type : Material (SUM=152.77, \$2,069.47)								
+	Folder : Sample Plan Takeoffs (SUM=152.77, \$2,069.47)								
	Hardwood Flooring	40 SQ FT per box, 1/2" x 5" Oak F	24.77	Box(s)	\$56.45	15	\$64.92	\$1,608.07	9 Finishes
	Ceiling Grid	300 SQ FT per Box	4	Box(s)	\$32.10	15	\$36.92	\$147.68	9 Finishes
	Acoustical Ceiling Tile	2' x 4' Tiles	124	EA	\$2.20	15	\$2.53	\$313.72	9 Finishes
+	Type : Price Per SQ FT (SUM=0.00, \$0.00)								
+	Folder : Takeoff (SUM=0.00, \$0.00)								
	Price Per SQ FT		0	SQ FT	\$0.00	0	\$0.00	\$0.00	
+	Type : Roof Area (SUM=0.00, \$0.00)								
+	Folder : Takeoff (SUM=0.00, \$0.00)								
	Roof Area		0	SQ FT	\$0.00	0	\$0.00	\$0.00	
+	Type : Segment (SUM=28.13, \$0.00)								
+	Folder : Takeoff (SUM=28.13, \$0.00)								
	New Segment		28.13	FT	\$0.00	0	\$0.00	\$0.00	
+	Type : Subcontract (SUM=1.00, \$747.50)								
+	Folder : Sample Plan Takeoffs (SUM=1.00, \$747.50)								
	Installation Contract	Install only	1	EA	\$650.00	15	\$747.50	\$747.50	
								\$136,242.37	

At the bottom of the grid, there is a filter expression:  (IsTakeoffItem = True) or (Type in (Material, Labor, Equipment, Subcontract, Other, Part, Assembly))

Figure 45-A



The **Columns** button on the **Reports** tab opens the **Reports Columns** window, which allows you to define the columns and the data types (Fig. 45-B). Data is populated from the properties of the items in the **Estimating** tab.

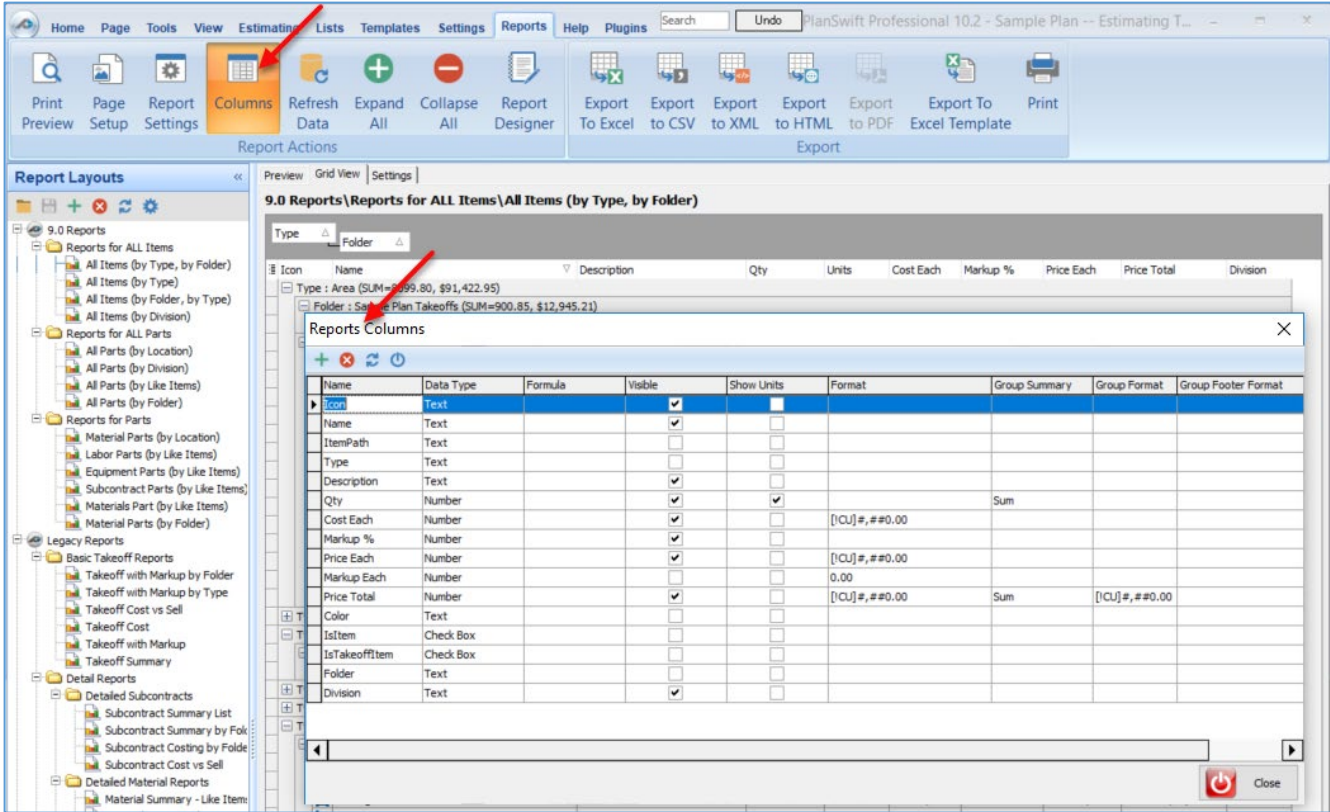

Figure 45-B

Clicking on **Customize** (found in the bottom-right corner of the **Grid View** tab) opens the **Filter builder** window (Fig. 45-C). New conditions and groups can be added and removed or modified using Data and commands from the drop-down menus. Data is populated from the visible columns in the report, and those columns pull Data from the properties of the items in the **Estimating** tab.

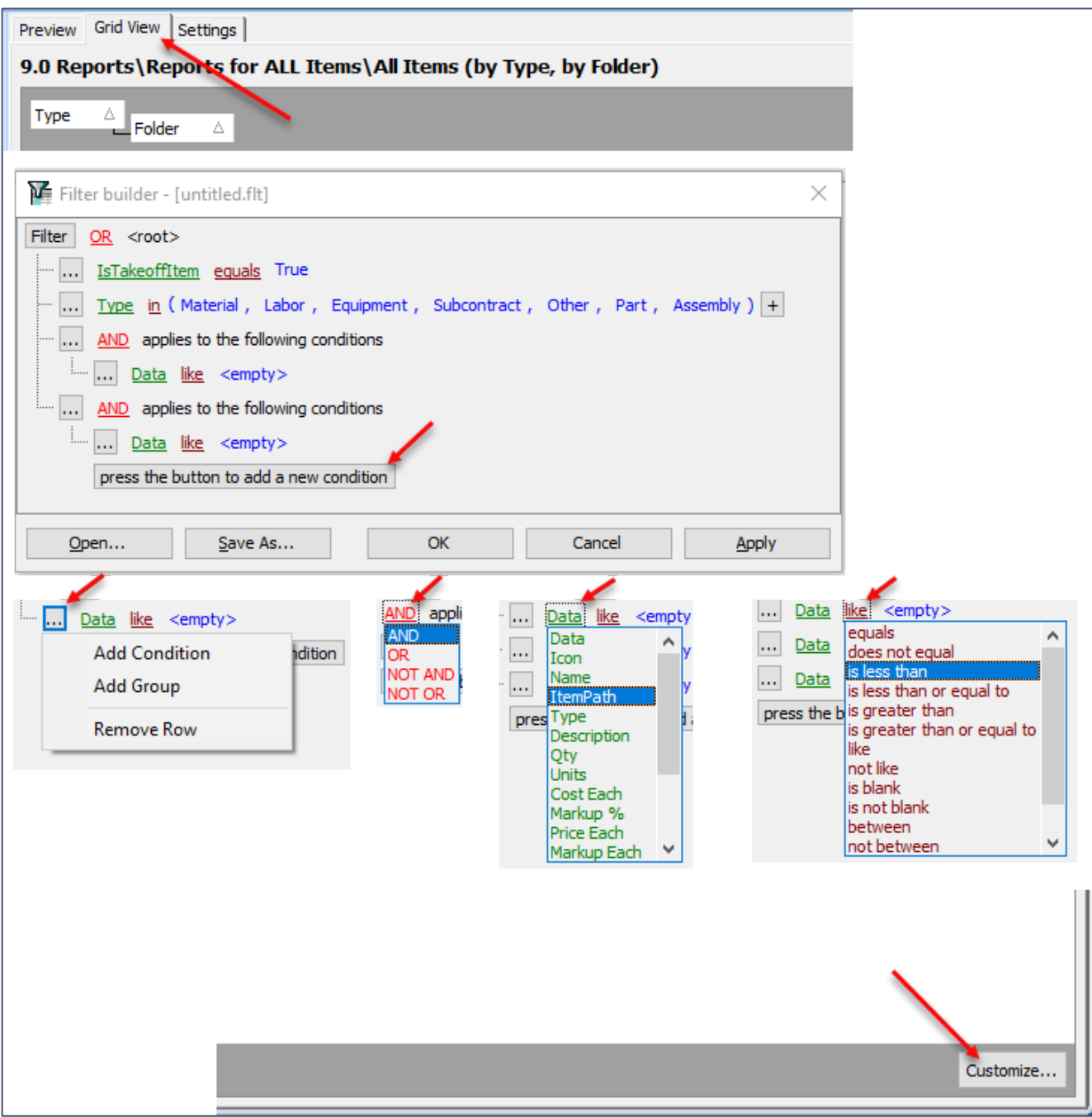

Figure 45-C

The **Report Settings** button opens the **Format Report** window and allows you to set up the formatting for the **View, Behavior, Formatting, Styles, Preview Cards, and any Charts** (Fig. 45-D).

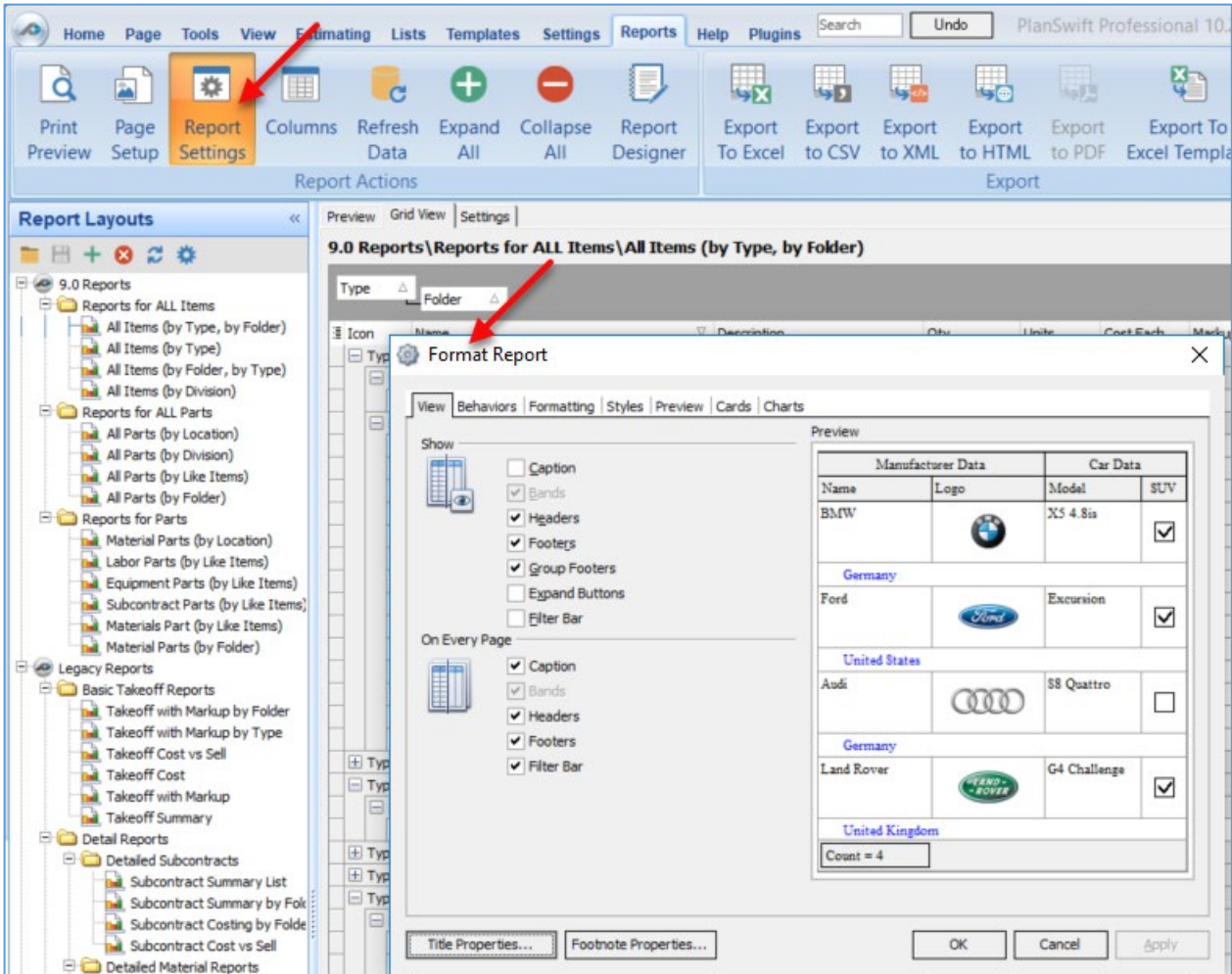

Figure 45-D

Once you have filtered the data and set up the report settings and columns the way you want, the **Page Setup** button on the **Reports** tab opens the **Page Setup** window and allows you to set up page orientation, print order, shading, paper size, and the paper source (Fig. 45-E). You can preview the report by clicking on **Print Preview** at the bottom of the **Page Setup** window or the **Print Preview** button on the **Reports** tab ribbon-bar.

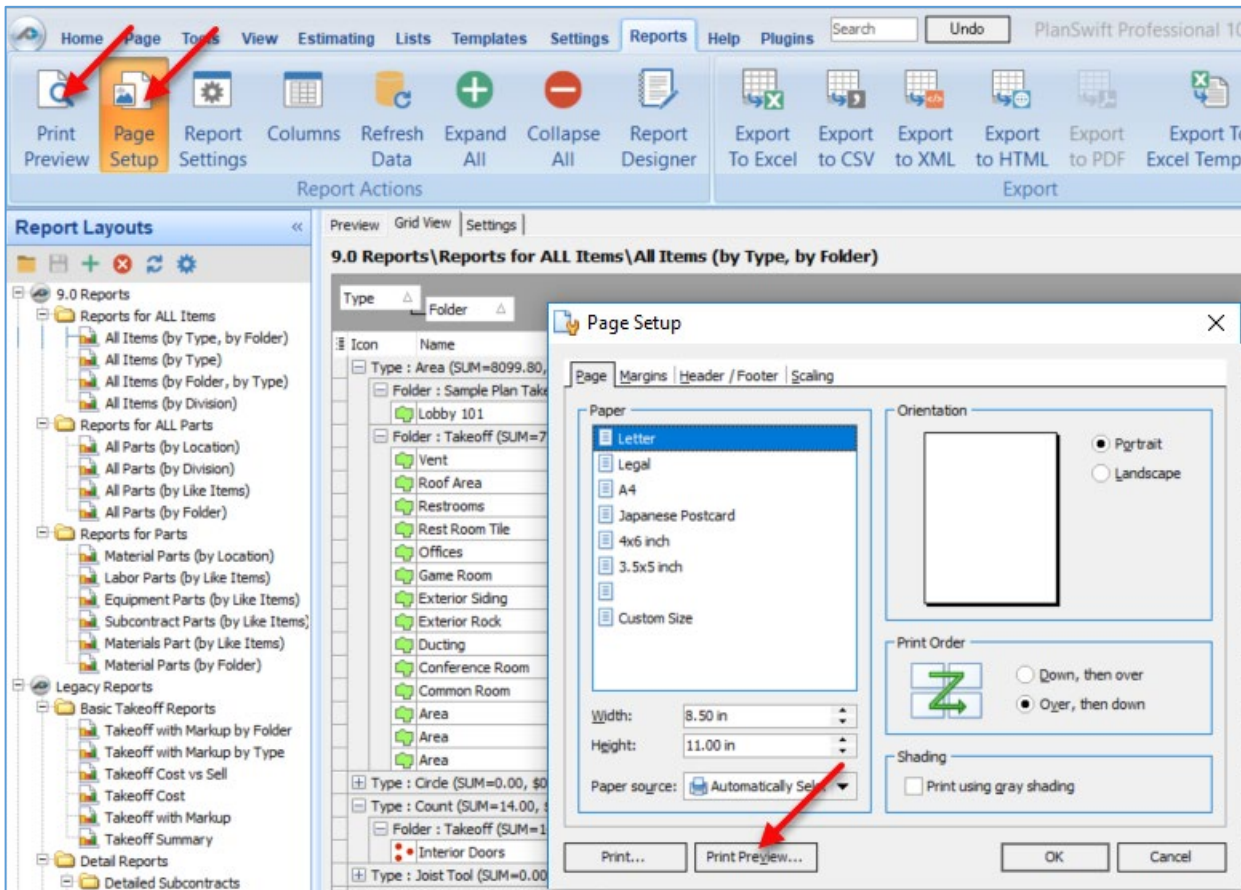

Figure 45-E

Clicking **Print Preview** opens the **Preview PlanSwift Report** window and allows you to make further refinements before you print the report (Fig. 45-F).

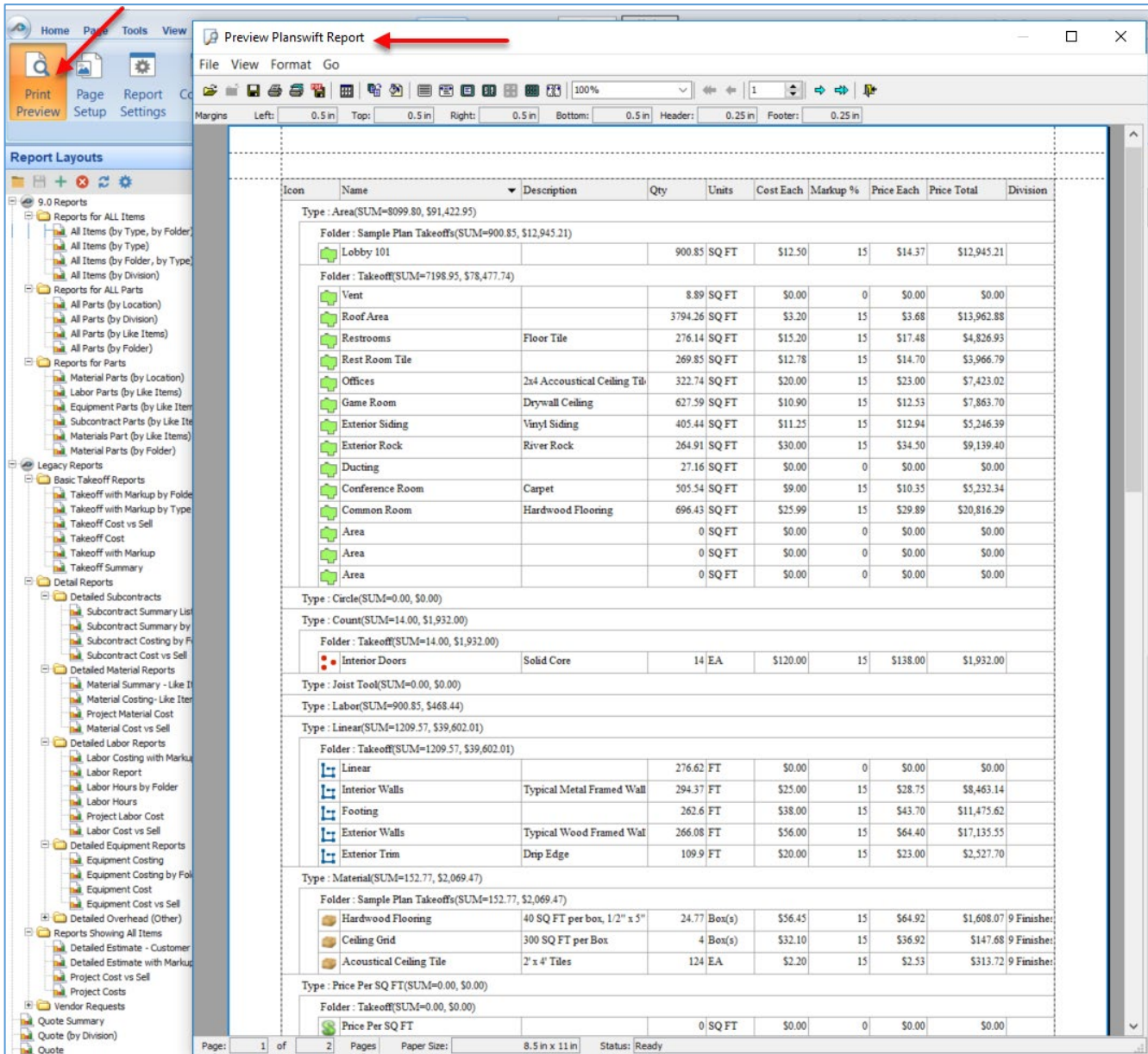

Figure 45-F

# Report Designer

Once you have set up your report with the basic report engine, you can click on **Preview** to see the report data as you set it up with the basic report designer (Fig. 45-G). Notice that when you click on **Preview**, the only **Report Actions** group buttons now available are the **Page Setup** and the **Report Designer** button.

Note: The **Report Designer** button will not be visible until it is turned on in the [Interface Settings](#) available on the **Settings** tab of the **Main** ribbon-bar menu.) When the **Show ReportDesigner** checkbox is checked, the **Report Designer** button is displayed on the **Reports** tab. Before the button is displayed, you are asked to confirm that this is an advanced tool that may require [additional training](#) that is not covered under the annual maintenance agreement.

The **Print Preview**, **Columns**, **Refresh Data**, **Expand All** and **Collapse All** buttons are only associated with the basic report engine, and so they are not selectable. The **Page Setup** button opens the **Page Settings** window, also shown in Fig. 45-G, where you can set page size, orientation, and margins for the current page or for all pages.

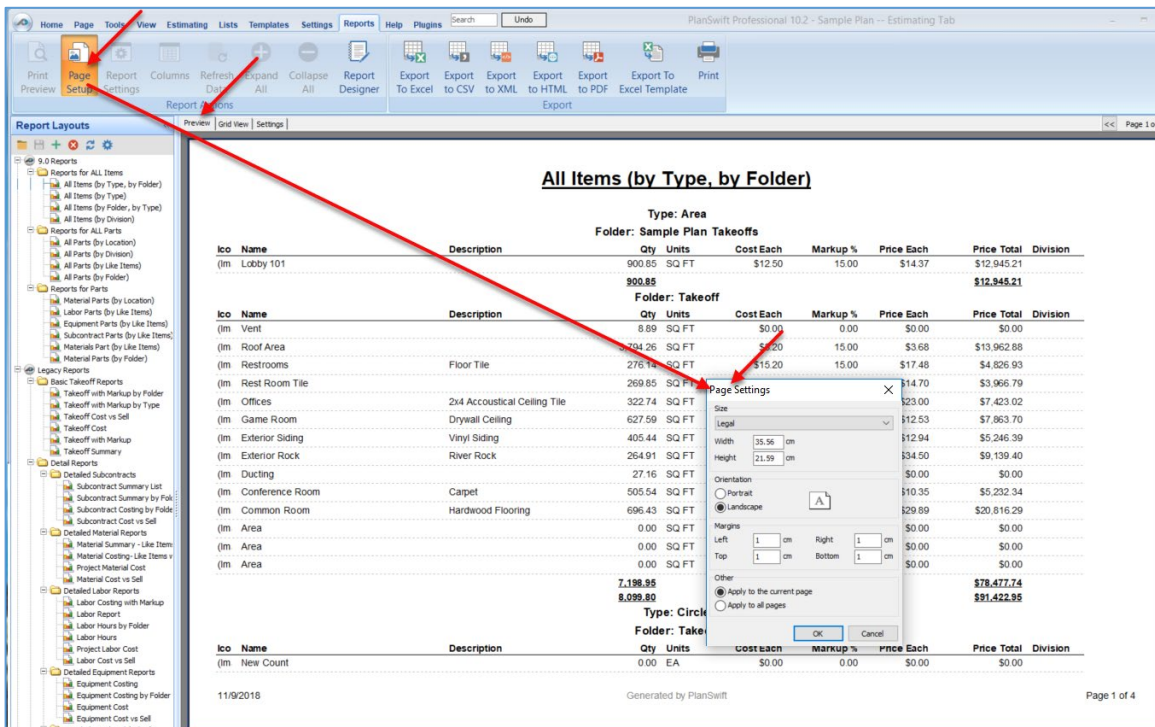

Figure 45-G

Clicking on **Settings** allows you to enter bid information and terms and conditions (Fig. 45-H). This button is also associated with the **Report Designer** engine, so information that is entered here will be available when you click on the **Report Designer** button. The four reports indicated in the **Reports Layouts** window are reports that have been created by the **Report Designer**. These reports can be used, copied, and modified, and the information in the **Settings** screen will apply only to those and to any copies made from them. The **Settings** information is not associated with any of the **9.0 Reports** or the **Legacy Reports** in the **Report Layouts** window.

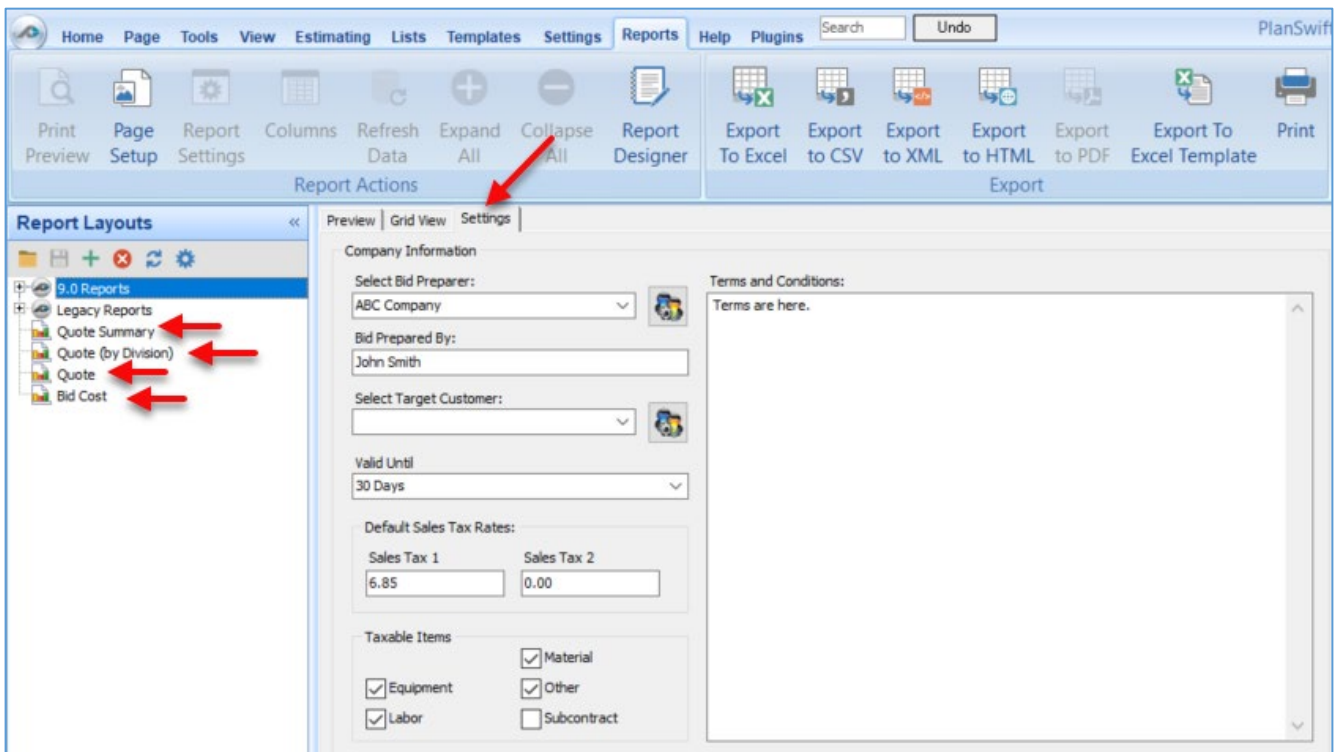

Figure 45-H

Clicking on the **Report Designer** button opens the **SwiftReport** window (Fig. 45-I), which shows a default report design.

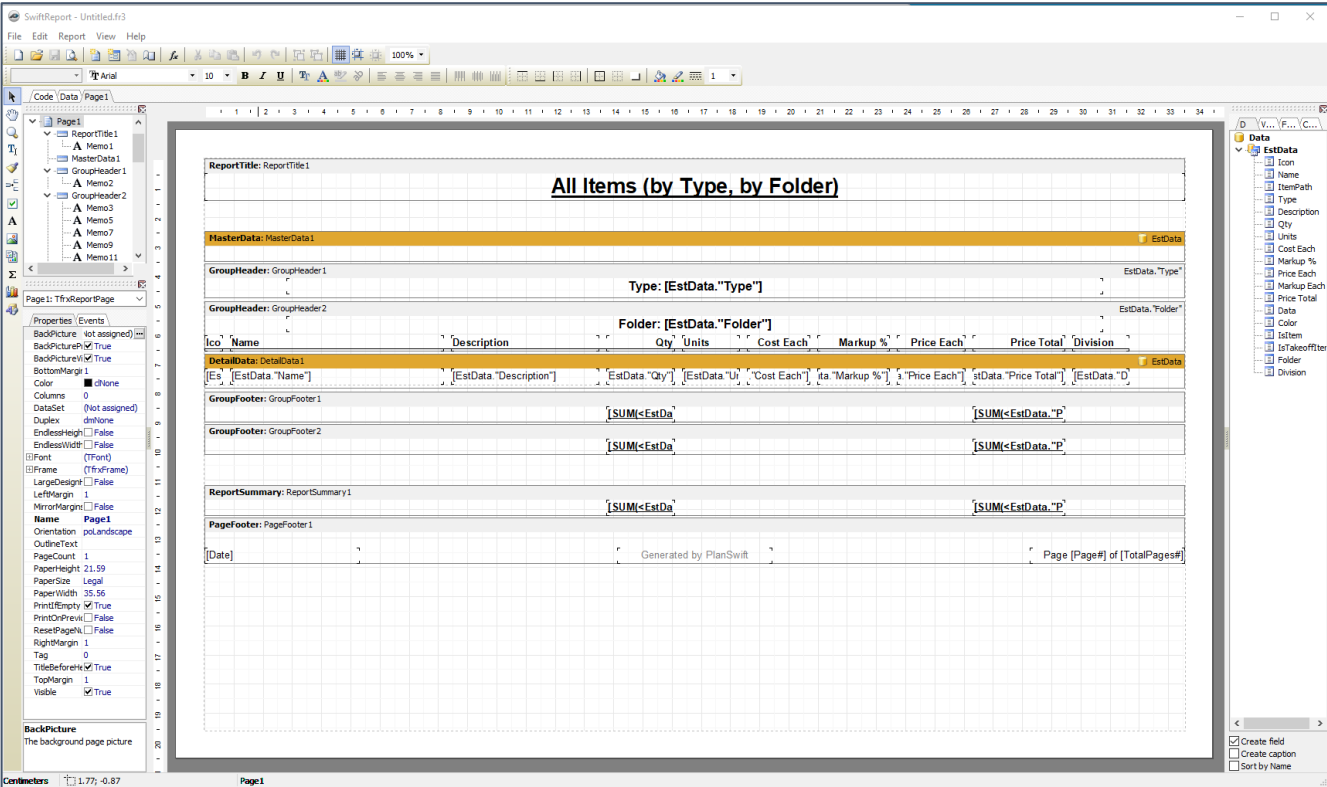

Figure 45-I



If you click on the **Preview** button in the **SwiftReport** Window, a **Preview** window opens (Fig. 45-J), showing the same data you developed using the simple report engine (see Fig. 45-G). Use the **Report Designer** tools from here to modify the report as required. Note that you may need additional training to utilize **Report Designer**. Please [contact PlanSwift for this training](#).

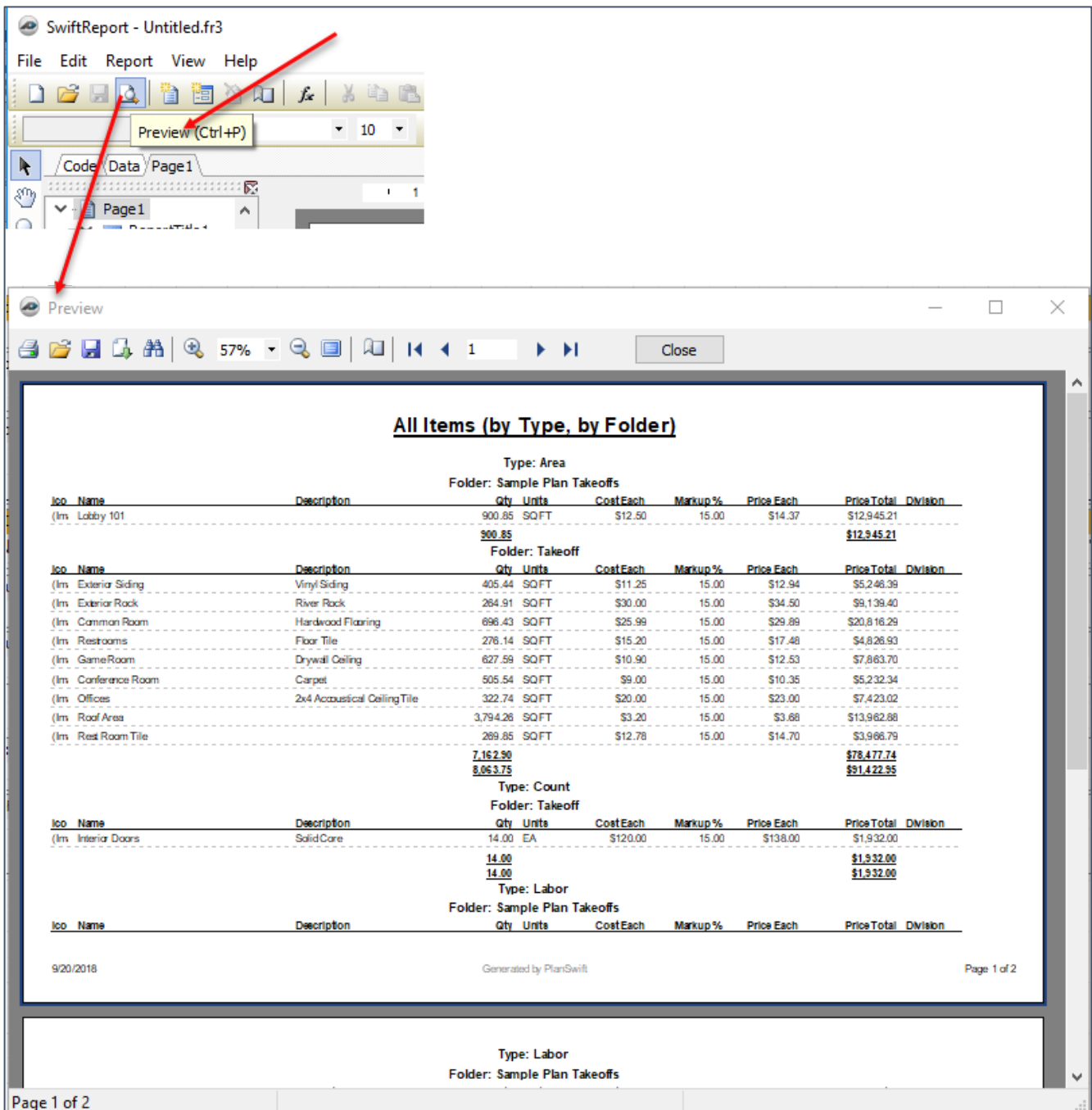

Figure 45-J

Figure 45-K shows an example of a **Reports Design** report showing a **Quote (by Division)** layout.

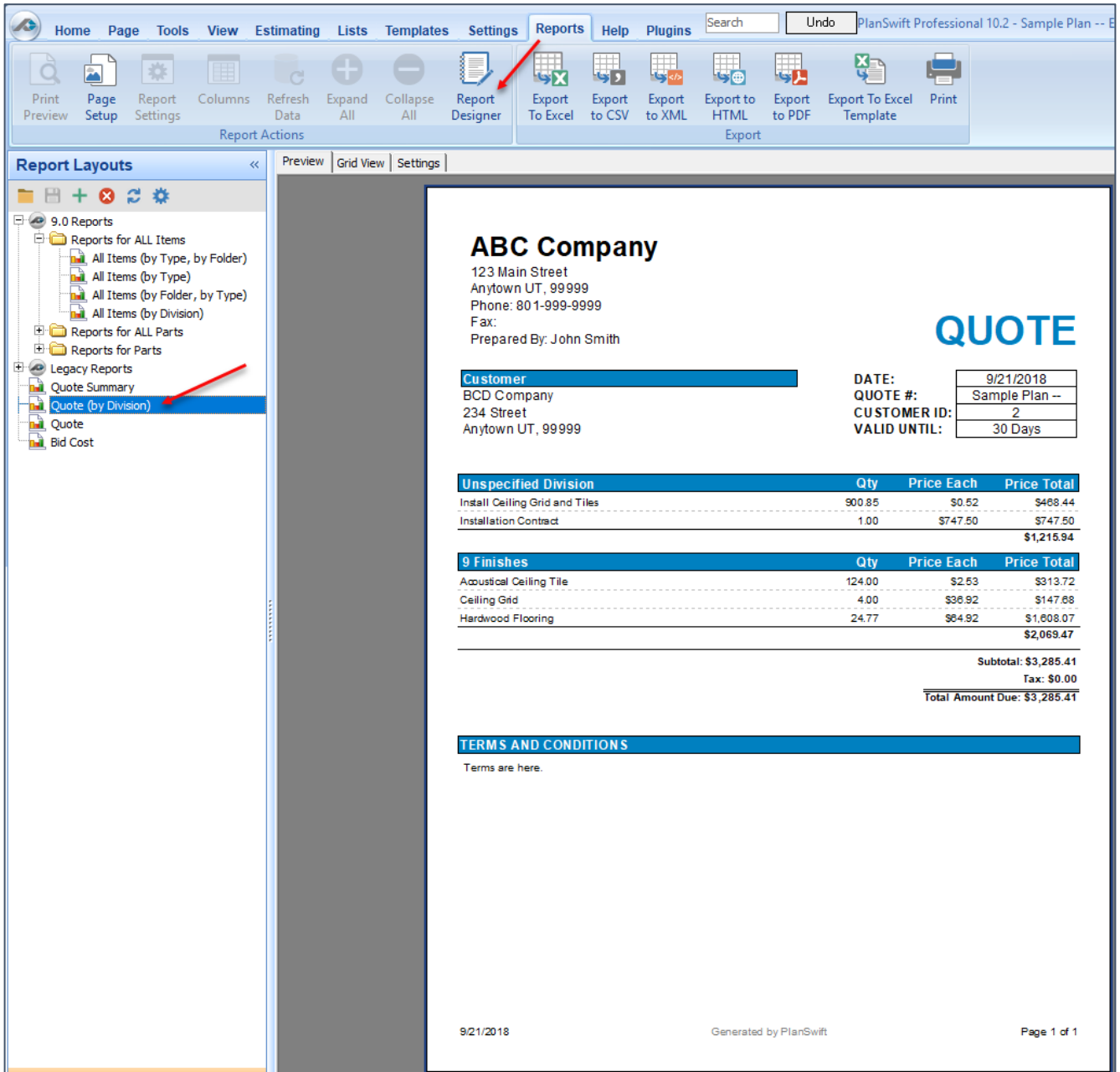

Figure 45-K

# Plugins Overview

PlanSwift was designed to be expandable through the addition of plugins. Plugins allow you to quickly and easily customize your PlanSwift platform and differentiate you from your competition. Plugins are comparable to apps for a smart phone because they enhance the capabilities of PlanSwift’s core utility.

Plugins, or add-ons, include custom applications and custom content. Custom application plugins are of three main plugin types: Shell Execute, Executable, and Script Code. Custom content plugins can include templates, parts, assemblies, lists, estimating layouts, and reports. Plugins can be either content-only (such as any **Starter Pack**), or an application only (such as **SwiftMaps** or **Excel Import Tool**), or a combination of both content and an application (such as **EarthWorkPro**).

Clicking on the **Plugins** tab (Fig. 46-A) opens the PlanSwift Plugin Store, where you can select from various plugins. Starter Packs contain a large library of prebuilt templates, parts, and assemblies, which can be modified to users’ specific needs. Utilizing a starter pack is a good starting point for building custom parts and assemblies. Each plugin has its own User Guide with instructions for installation and use and a compendium listing all included parts and assemblies.

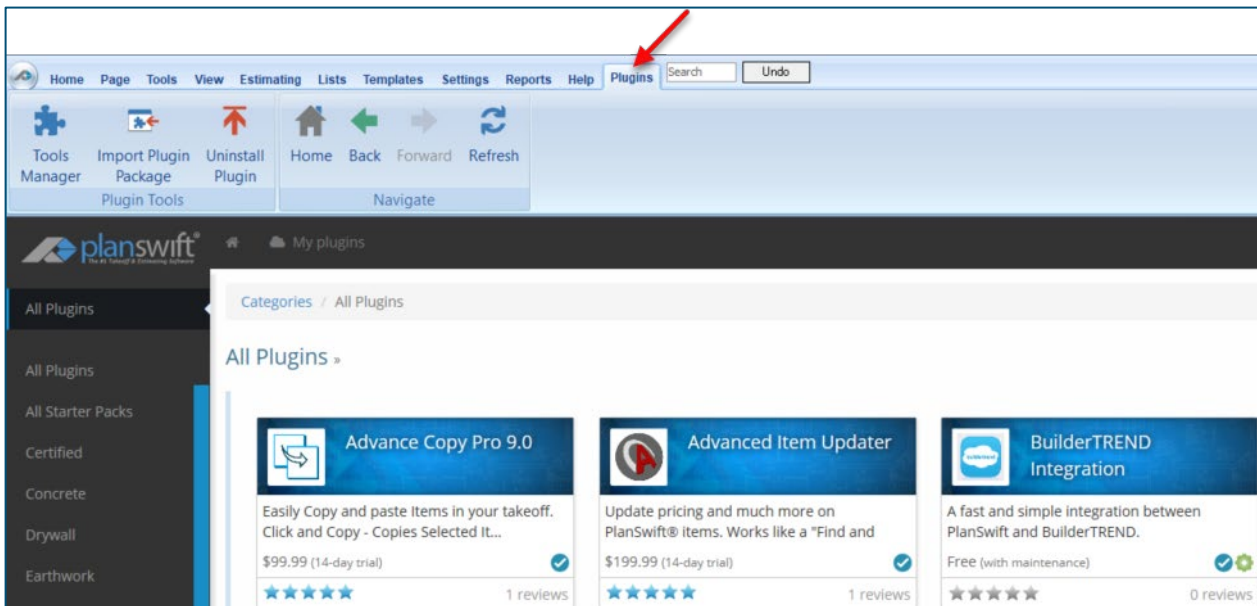

Figure 46-A

# Advanced Features Overview

The Advanced Features Overview will cover the buttons on the [Page](#) tab, the [Tools](#) tab, [View](#) tab, [Lists](#) tab, and [Settings](#) tab.

## Page Tab

The **Page** tab allows for page manipulations, such as adding, renaming, rotating, flipping, inverting, cropping, copying, setting the origin and offset origin, and closing (Fig. 47-A).

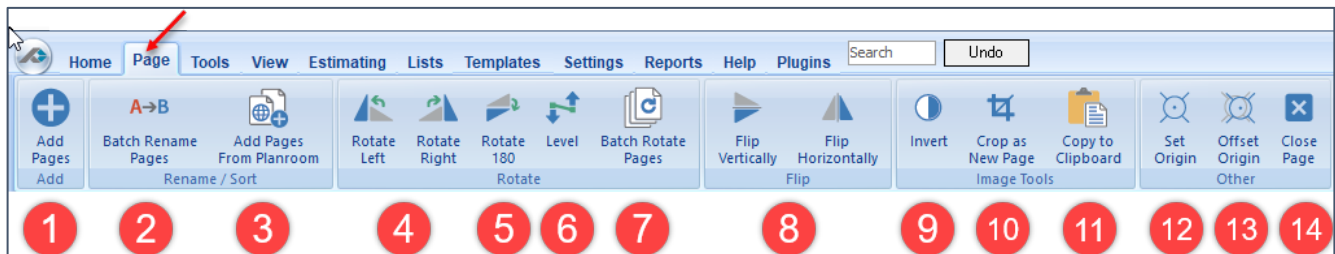

Figure 47-A

1. The **Add Pages** button is covered under *Importing Additional Pages* in this User Guide.
2. The **Batch Rename Pages** button is covered under *Batch Renaming Multiple Pages* in this User Guide.
3. The **Add Pages From Planroom** button is not implemented.
4. The **Rotate Left** and **Rotate Right** buttons rotate the page left or right 90 degrees each time they are clicked on. These buttons do not function if the page has any objects (such as takeoffs, notes, etc.) on it. The **Undo** button does not undo a rotation.
5. The **Rotate 180** button rotates the page 180 degrees. This button does not function if the page has any objects (such as takeoffs, notes, etc.) on it. The **Undo** button does not undo a rotation.
6. The **Level** button allows you to click on two **Points** on the page and have the drawing leveled to those two **Points**. Items such as takeoffs are also leveled. The **Undo** button does not undo any change in level.

- 
7. The **Batch Rotate Pages** button opens the **Batch Rotate** window (Fig. 47-B). The **Batch Rotate Pages** tool rotates both the page and the takeoff items. You can start the rotation at the first page, the current page, or the selected page (or pages). To select multiple pages, hold the **Ctrl** key down to select the pages (from the **Pages, Bookmarks** window) that are to be rotated before clicking on the **Batch Rotate Pages** button. Select **Rotate Left**, **Rotate Right**, or **Rotate 180**, then click on **Start** to begin the rotations. A status bar shows the progress. The **Undo** button does not undo any batch rotations.

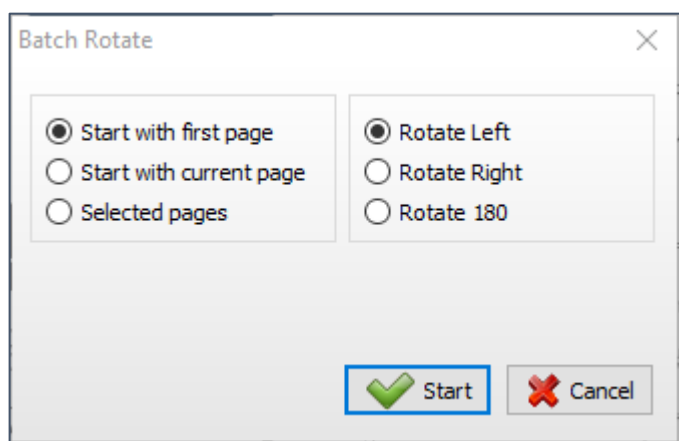

Figure 47-B

8. The **Flip Vertically** and **Flip Horizontally** buttons flip the currently displayed page and any takeoff items either vertically or horizontally. The **Undo** button does not undo flips.
9. The **Invert** button inverts the page color, so black becomes white and white becomes black. Takeoff colors remain the same. Click **Invert** a second time to un-invert a page.

10. The **Crop as New Page** button allows you to select an area on a page and copy that area to a new page:

- a. Click on one corner of the area to be cropped (Fig. 47-C).
- b. Drag a box over the area to be cropped.
- c. In the **Properties – [New Page]** window, give the new page a name.
- d. Click on **Ok** to create the page.

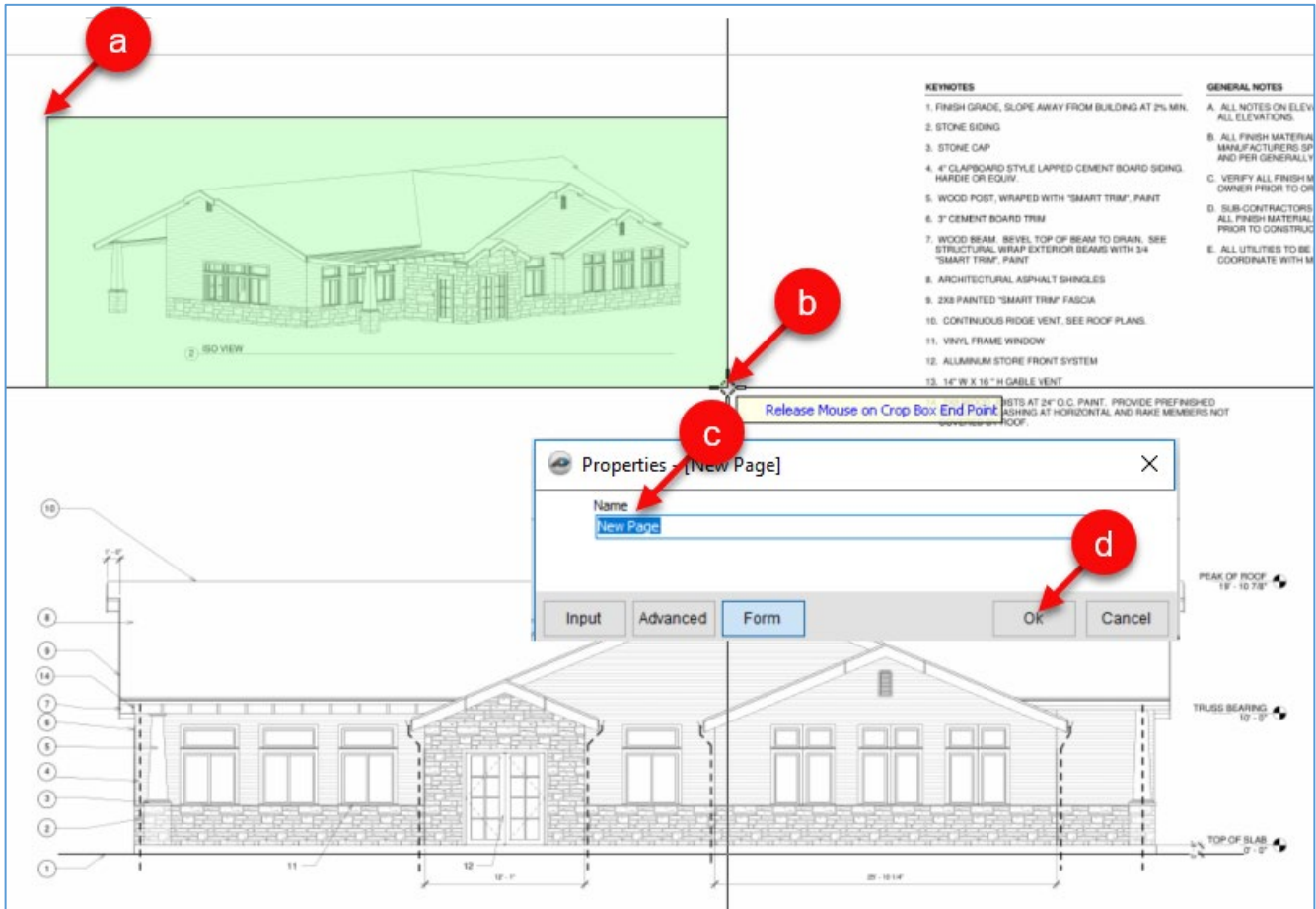

Figure 47-C

11. The **Copy to Clipboard** button allows you to select an area on a page (by dragging a box) and copying that area to the Clipboard. You can then paste it into any other application.

12. The **Set Origin** button is used (rarely) to set the grid origin **Point**.

13. The **Offset Origin** button is used (rarely) to set an offset to a grid origin **Point**.

14. The **Close Page** button closes the currently displayed page.

## Tools Tab

The **Tools** tab provides tools that allow you to rotate and flip takeoff items, calculate the pitch and angle of two **Points**, calculate the angles and lengths of legs of triangles, convert PDF to TIF files, zip and unzip jobs (covered [here](#)), attach an Excel file to a job, open an Excel file in a job, and save a screenshot (Fig. 48-A).

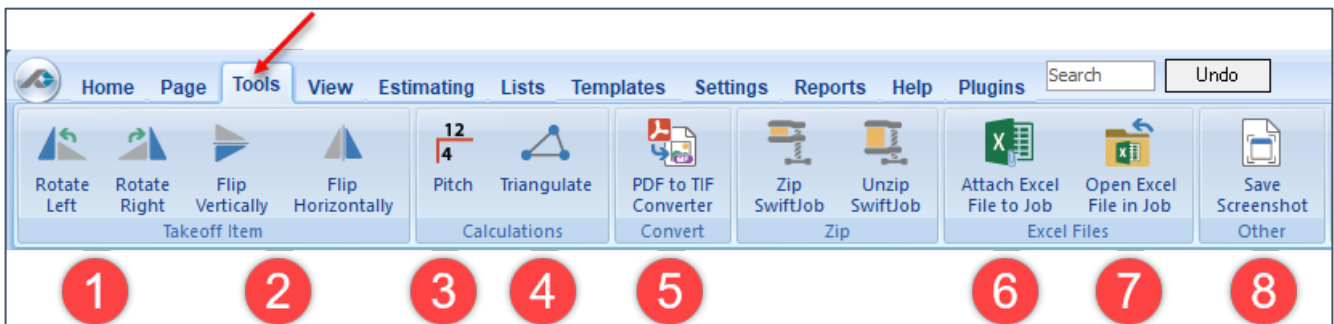

Figure 48-A

1. The **Rotate Left** and **Rotate Right** buttons will rotate a selected takeoff item (or items) left or right.
2. The **Flip Vertically** and **Flip Horizontally** buttons will flip a selected takeoff item (or items) either vertically or horizontally.

3. The **Pitch** button measures the pitch of any two **Points** clicked on. To measure the pitch of two **Points**:
  - a. Click on the **Pitch** button on the **Tools** tab (Fig. 48-B).
  - b. Click on the first **Point**.
  - c. Click on the second **Point** (remember to press the **M** key on the keyboard to enlarge an area if needed).
  - d. A window opens showing the **Pitch** and the **Angle**.

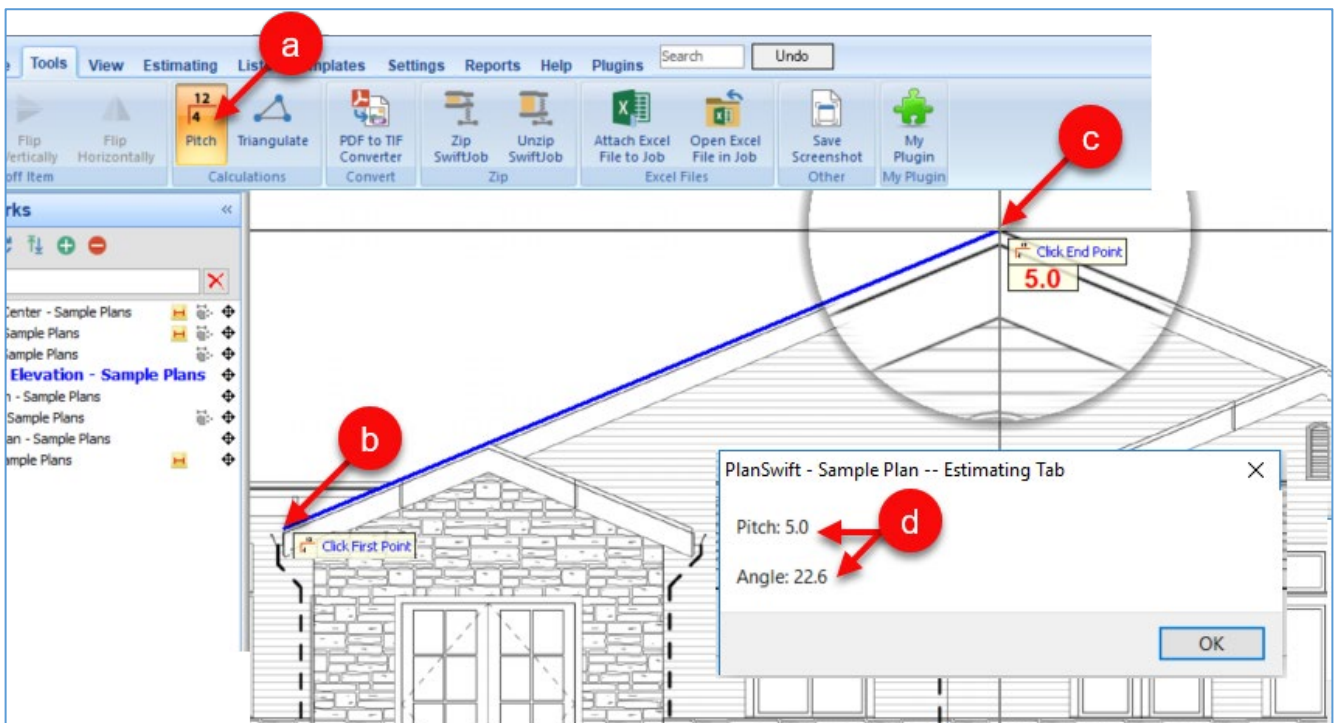

Figure 48-B



4. The **Triangulate** button measures the angles and lengths of a triangle's legs. To obtain the measurements of a triangle's legs and angles:
  - a. Click on the **Triangulate** button on the **Tools** tab (Fig. 48-C).
  - b. Click on the first **Point** of the triangle.
  - c. Click on the second **Point** of the triangle.
  - d. Click on the third **Point** of the triangle. The values of the angles and lengths of the legs are displayed.

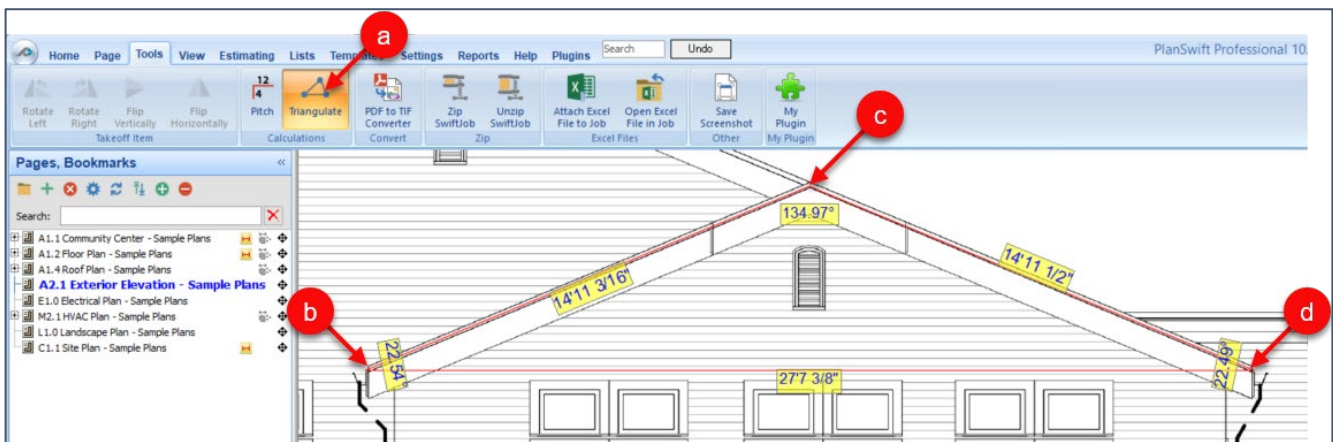

Figure 48-C

5. The **PDF to TIF Converter** button provides an easy way to convert PDF files to TIF files. To convert PDF files to TIF files:
  - a. Click on the **PDF to TIF Converter** button (Fig. 48-D).
  - b. This opens the **PDF to TIF Converter** window.
  - c. Click on **Select Folder** and navigate to the PDF file location.
  - d. Select the PDF file to be converted to TIF.
  - e. Select the output folder. The **DPI for TIF Files** and **Format** (grayscale) of the output can also be selected.
  - f. Click on **Convert**.
  - g. The converted files are listed in the lower window.

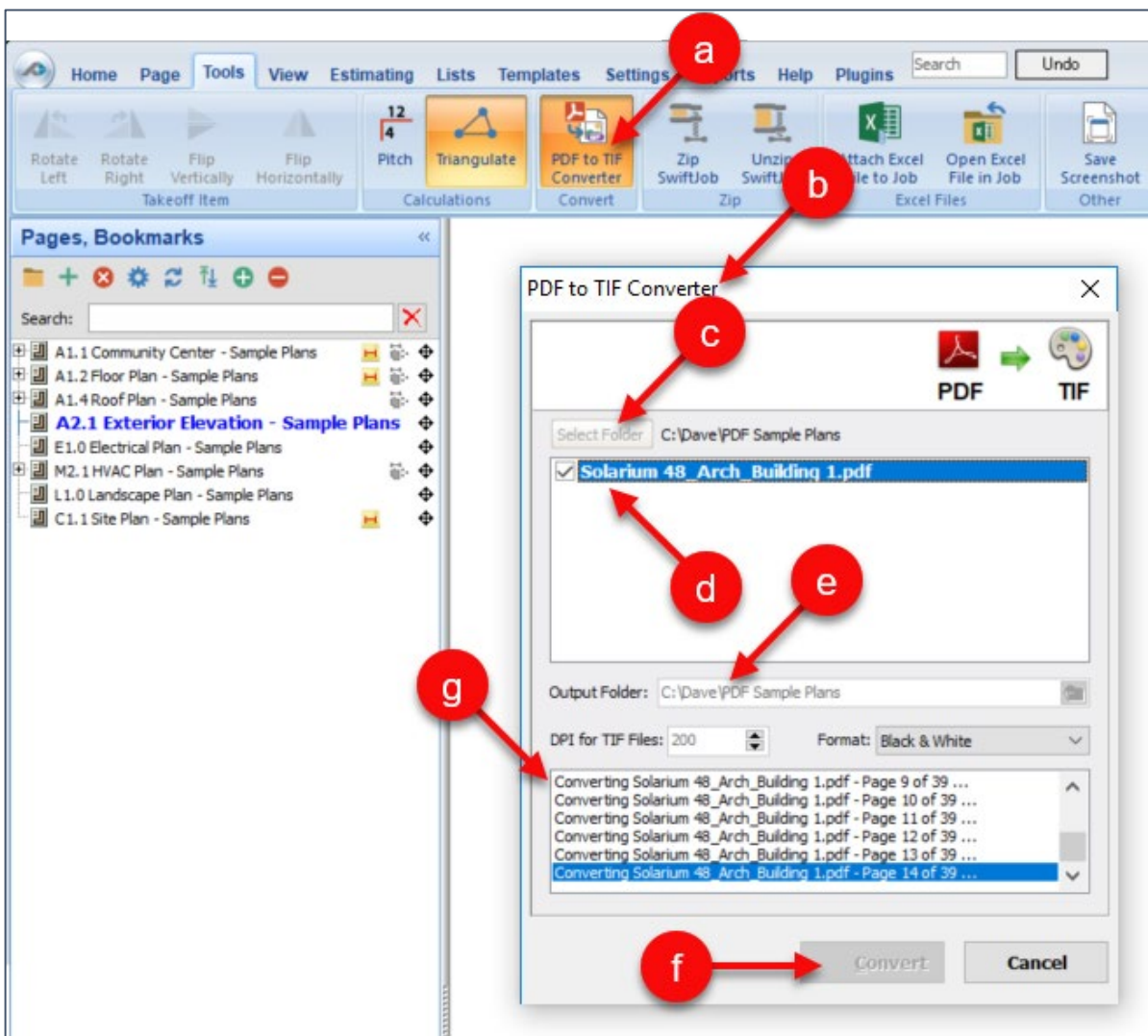

Figure 48-D

6. The **Attach Excel File to Job** button allows you to attach an Excel file to the PlanSwift job and stores it under **Attachments**. To attach an Excel file to a job:
  - a. Click on **Attach Excel File to Job** button on the **Tools** tab (Fig. 48-E).
  - b. Navigate to the location where the Excel file is stored.
  - c. Click on the file to be attached.
  - d. Click on **Open**.

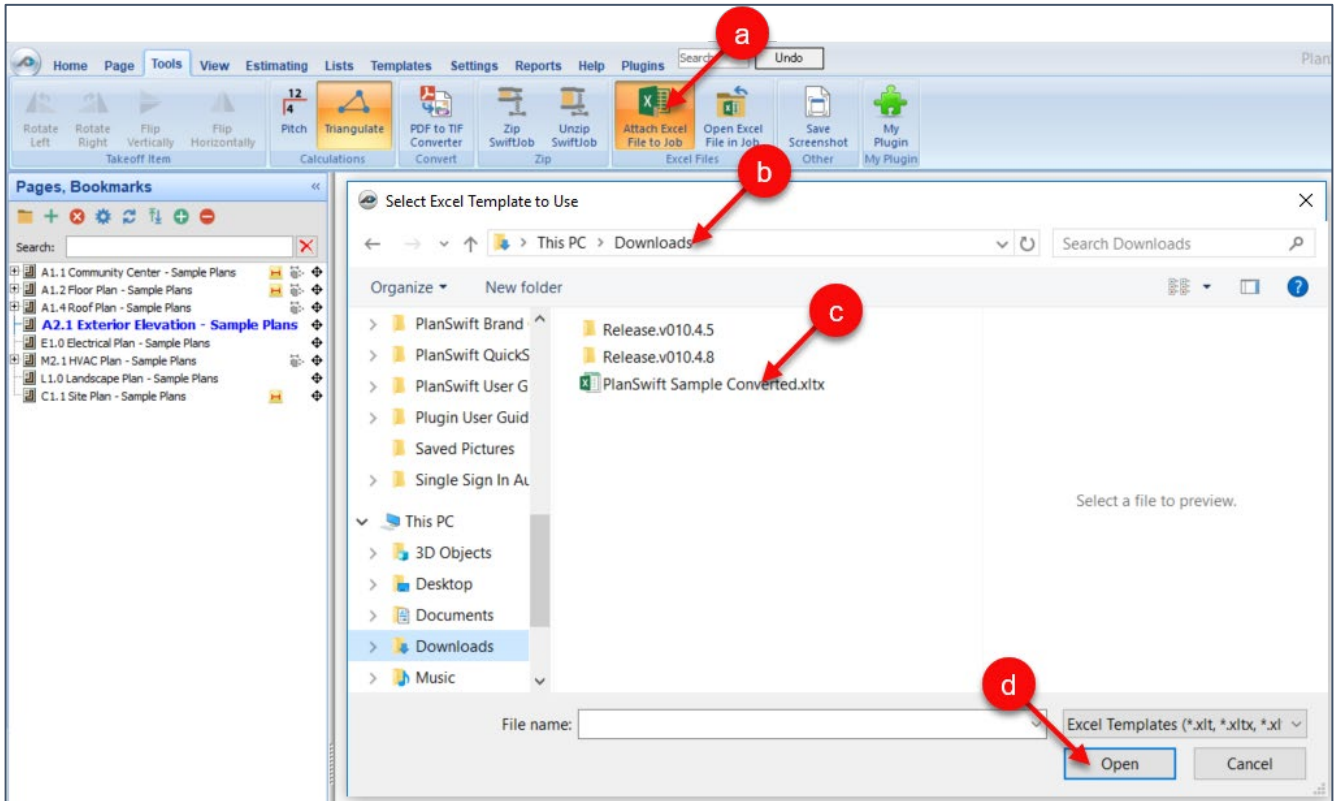

Figure 48-E

- e. The Excel file is stored in the **Attachments** window (Fig. 48-F).

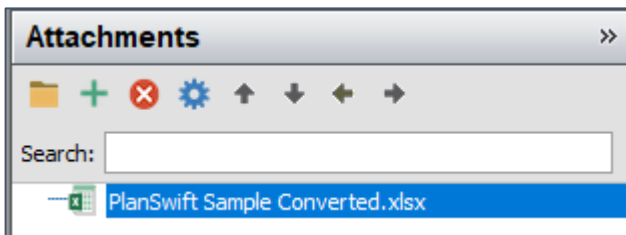

Figure 48-F

7. The **Open Excel File in Job** button allows you to easily open an Excel file. To open an Excel file:

- a. Click on the **Open Excel File in Job** button on the **Tools** tab (Fig. 48-G).
- b. Navigate to where the Excel file is.
- c. Click on the Excel file to be opened.
- d. Click on **Open**. Excel will open the selected file.

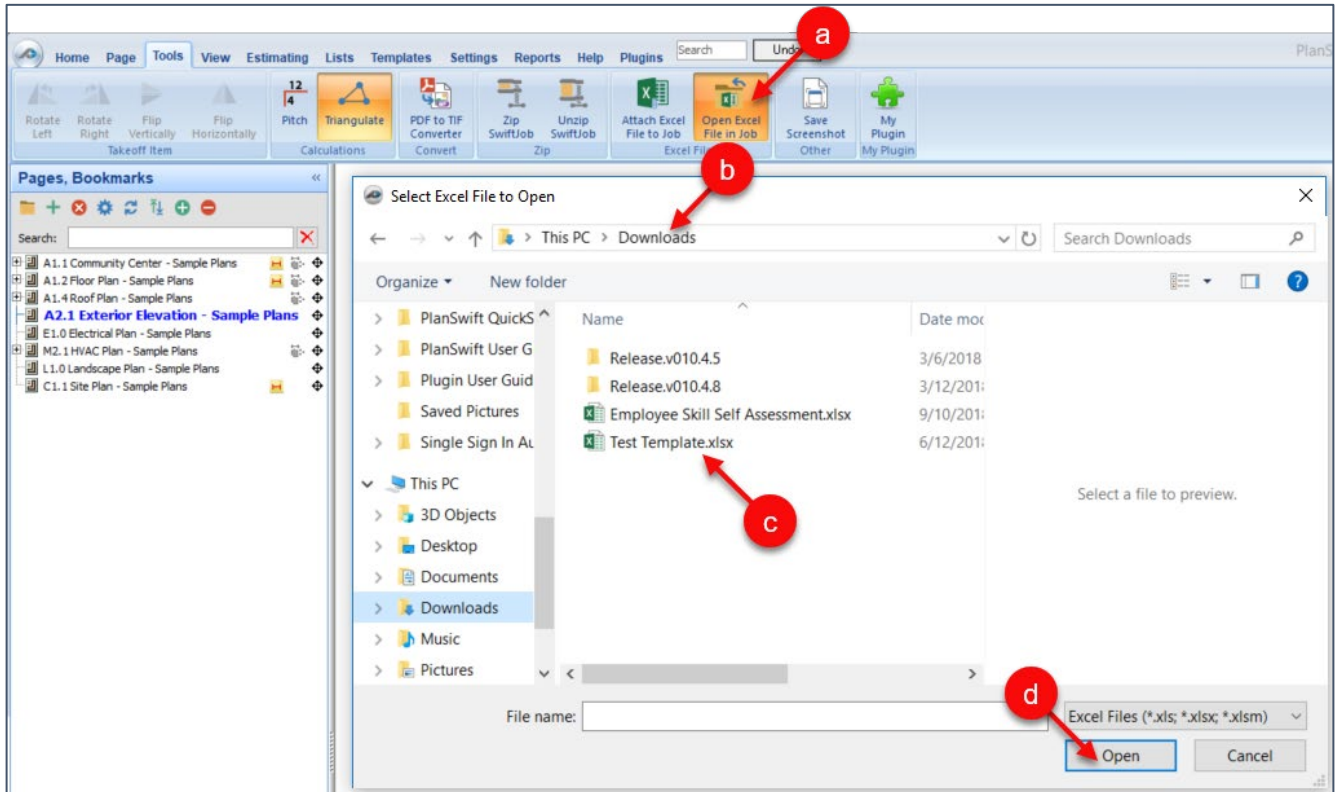

Figure 48-G

8. The **Save Screenshot** button captures the contents of the PlanSwift plan window, allows you to save it (as a JPG, JPEG, TIF, or BMP) with a name of your choice and in a location of your choice. To capture a screenshot:
  - a. Click on **Save Screenshot** from the **Tools** tab (Fig. 48-H).
  - b. Navigate to where you want the screenshot saved.
  - c. Enter a filename for the screenshot.
  - d. Select the image type (JPG, JPEG, TIF, or BMP).
  - e. Click on **Save** to save the screenshot in the location you specified.

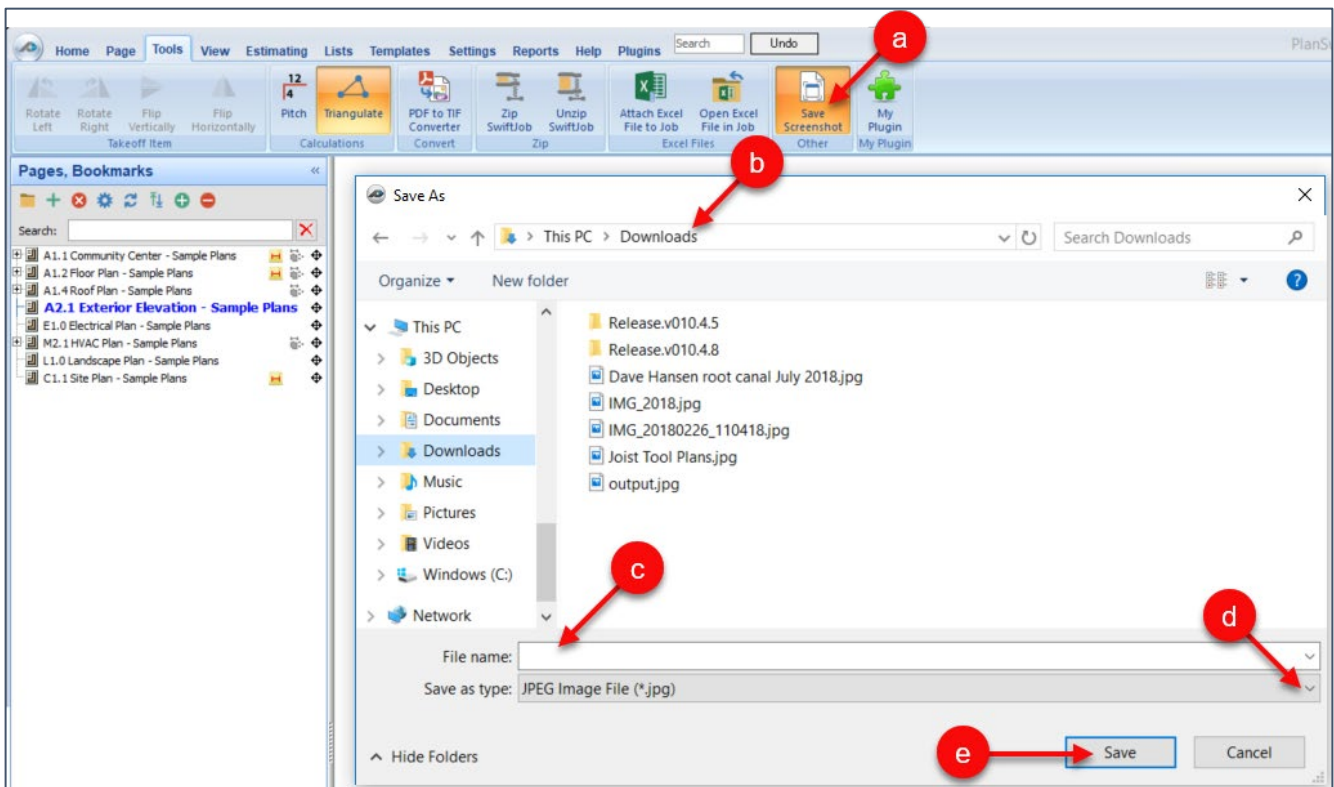

Figure 48-H

## View Tab

The **View** tab has two groups of buttons: **Show/Hide** and **Adjustments**. The buttons in the **Show / Hide** group do exactly what they say: they show and hide labels, items, overlays, dimensions, notes, and cut-lines (#1 of Fig. 49-A). The **Adjustments** group tools are more advanced (#2 of Fig. 49-A). To adjust labels, it's important to understand what a label is: a label is a special annotation that is created when a takeoff item is created (#3 of Fig. 49-B). By default, labels are not displayed. To display a label for a takeoff item, right-click on the takeoff item you want the label displayed for, then select **Show Label** from the drop-down menu (#4 of Fig. 49-B). The default settings for **Labels**, **Notes**, and **Dimensions** can be changed by clicking on **Annotations** in the [Settings](#) tab.

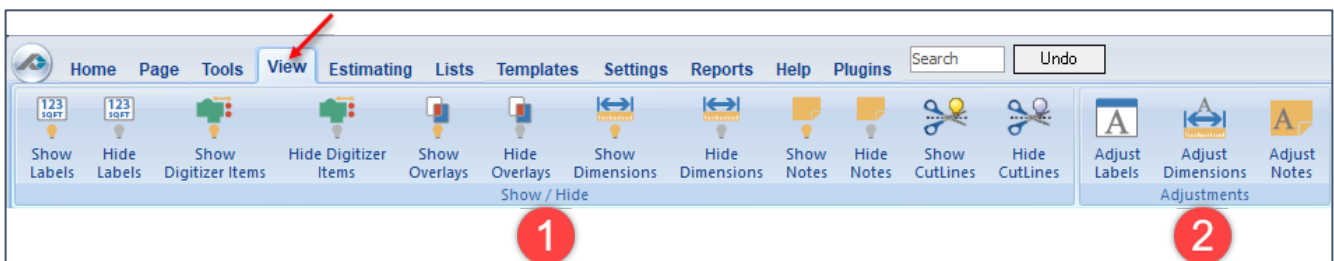

Figure 49-A

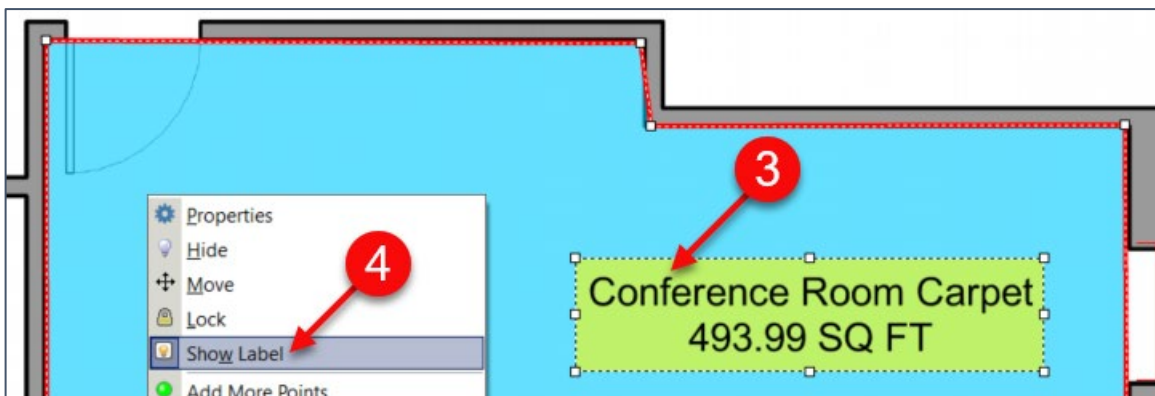

Figure 49-B

The **Adjust Notes**, **Adjust Dimensions**, and **Adjust Labels** buttons (Fig. 49-C) are explained next.

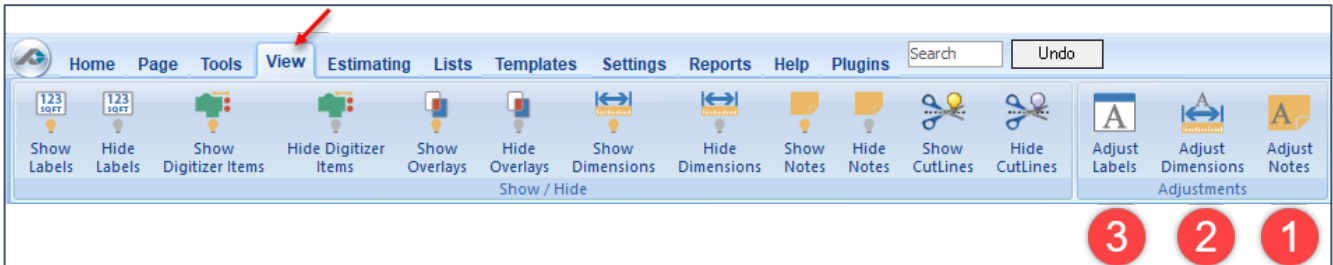

Figure 49-C

1. The **Adjust Notes** button allows you to change the properties of notes. To change the properties of a note:
  - a. Click on **Adjust Notes** from the **View** tab (Fig. 49-D).
  - b. This opens the **Adjust Notes** window. The **Font Color**, **Font**, **Background Color**, and **Border Color** are self-explanatory.
  - c. Change the **Height** of the font (“2” is twice as high as “1”).
  - d. Sliding the slider bar to the right lightens the transparency; left darkens it.

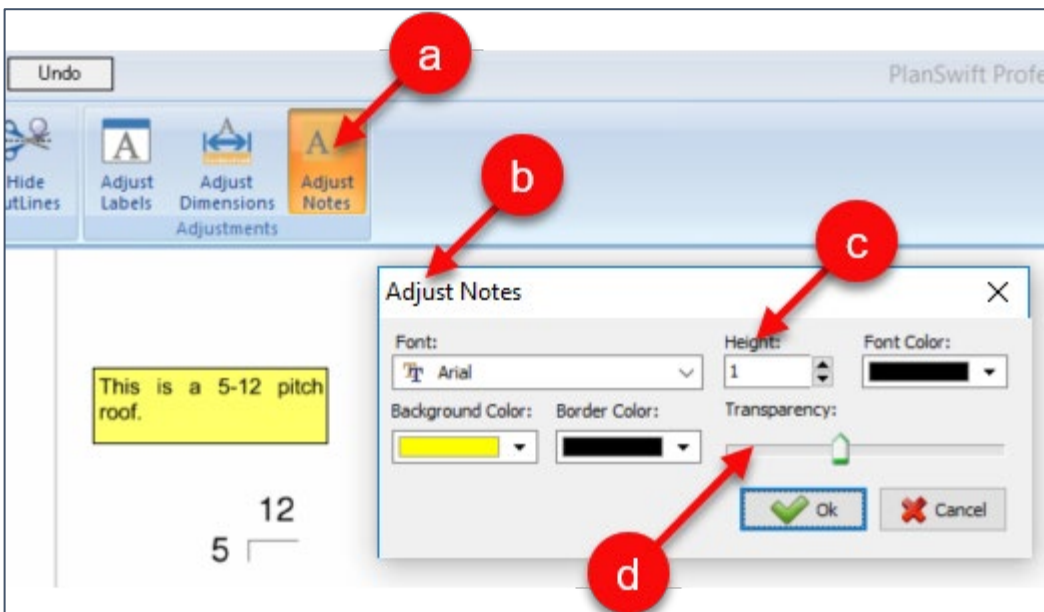

Figure 49-D

2. The **Adjust Dimensions** button changes the properties of dimension lines (Fig. 49-E). To change the properties of a dimension line:
  - a. Click on the **Adjust Dimension** button.
  - b. This opens the **Adjust Dimensions** window. The **Font** and **Font Color** are self-explanatory.
  - c. Change the **Height** of the font (“2” is twice as high as “1”).
  - d. Change the **Line Color** of the dimension line.

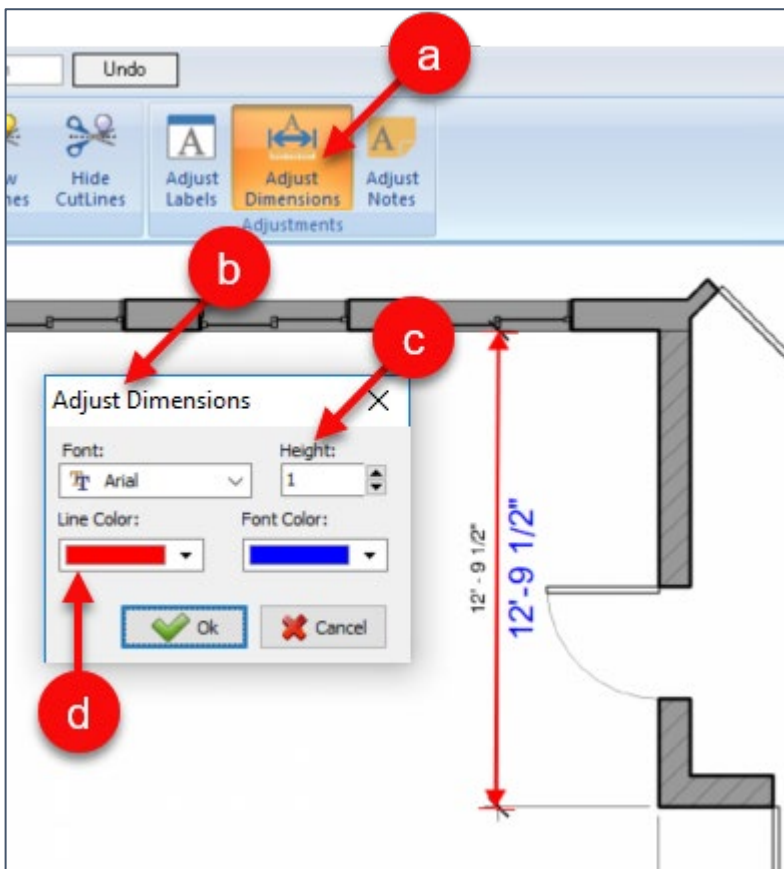

Figure 49-E



3. The **Adjust Label** button changes the properties of all labels on a page (Fig. 49-F). To change the properties of a label:
  - a. Click on the **Adjust Labels** button on the **View** tab.
  - b. This opens the **Adjust Labels** window. The **Font**, **Font Color**, **Background Color**, and **Border Color** are all self-explanatory. After you select a Background Color, sliding the transparency slider bar to the right lightens it; left darkens it.
  - c. Select the height of the **Font**; a “2” is twice as high as a “1”. Enter a “2”.
  - d. Figure 48-F shows the **Height** changes implemented.
  - e. It also shows the **Background Color** changed and the **Transparency** slider moved to the left.
  - f. The result with the larger font and lighter blue background is shown here.

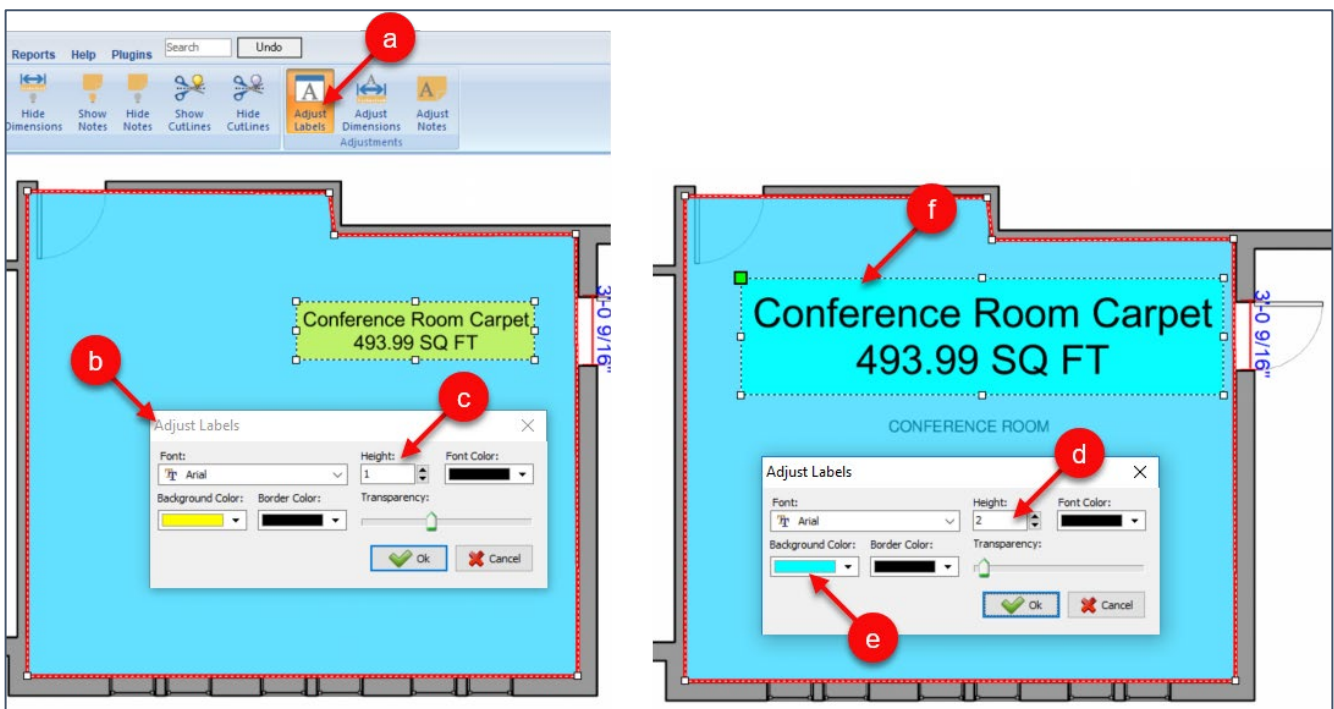

Figure 49-F

## Lists Tab

The **Lists** tab (Fig. 50-A) provides tools that allow you to create and edit drop-down menus for lists of items you need to enter frequently (for example, stud sizes). You can create new lists, delete lists, change the properties of lists, and create new folders or subfolders for the lists. The types of lists that can be created are **Simple Lists**, **Lists from MS Access File Tables**, and **ADO Query Lists**. The creation of a simple list, deleting, viewing properties, and creation of folders and subfolders is covered below. PlanSwift recommends a [training class](#) to use these more advanced features.

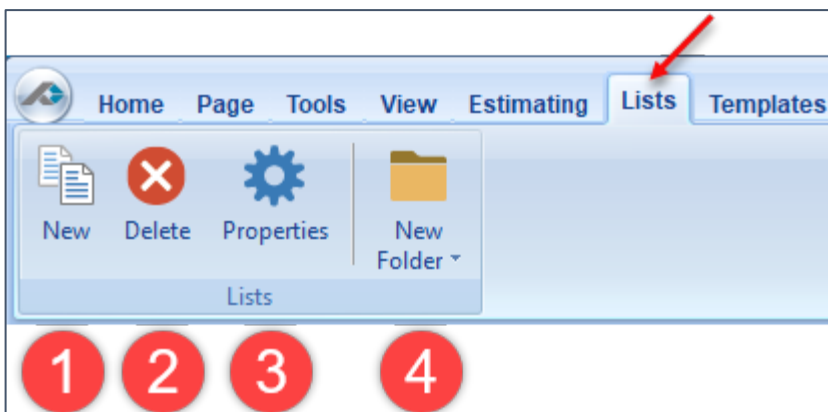

Figure 50-A

1. The **New** button opens the **New List – Select List Type** window from which you select the list type (Fig. 50-B). To select a list type:
  - a. Click **Simple List**.
  - b. Click **Next**.
  - c. In the **New Simple List** window, enter a name for the list.
  - d. Click **Next**.

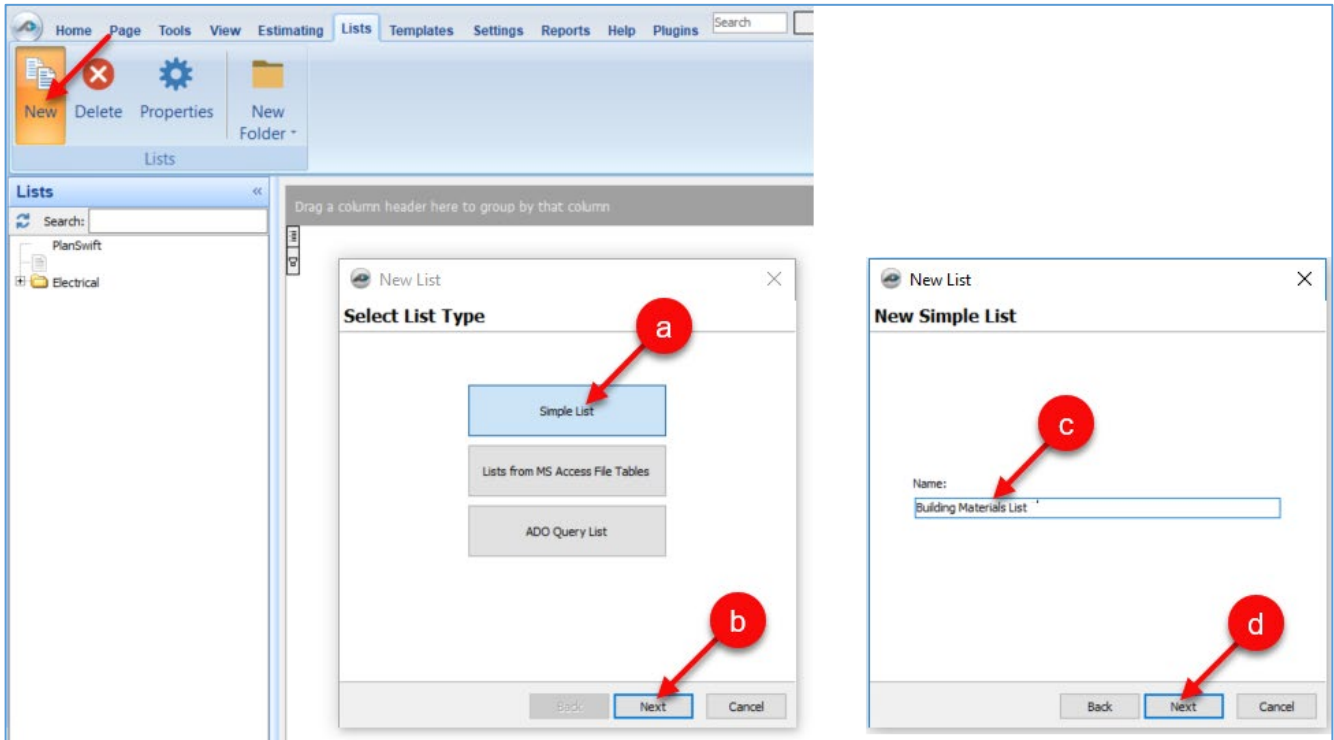

Figure 50-B

- e. Enter your list items in the window. If your lists include formulas, check the **Parse Formula** box (Fig. 50-C).

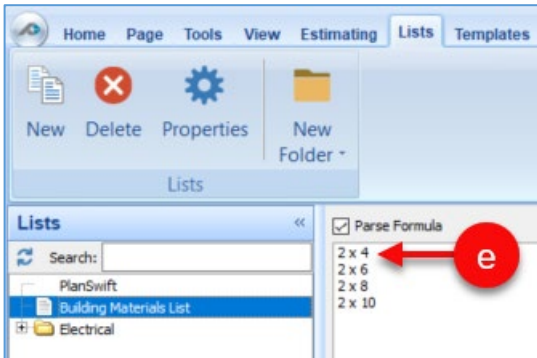

Figure 50-C

2. The **Delete** button deletes any list or folder that is selected. Right-clicking any list displays a drop-down menu that allows you to delete a list or folder.
3. The **Properties** button displays the **Properties—[listname]** window (Fig. 50-D), where more advanced features (**Input**, **Advanced**, and **Form**) are available. The properties button is also available by right-clicking any list or folder. PlanSwift recommends a [training class](#) to use these advanced features.

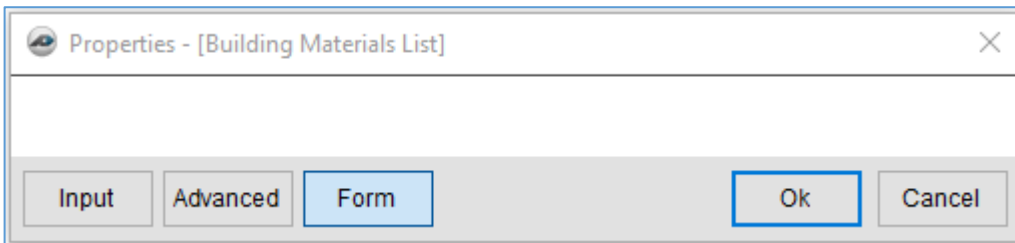

Figure 50-D

4. The **New Folder** button allows you to create a folder or subfolder. The top half of the button creates a folder at the same level as any selected list or folder. The drop-down half of the button creates a sub-folder to any selected list or folder.

# Settings Tab

## Customizing the Interface

The **Interface** selection (Fig. 51-A) on the **Settings** tab of the ribbon-bar menu provides a way to change different settings.

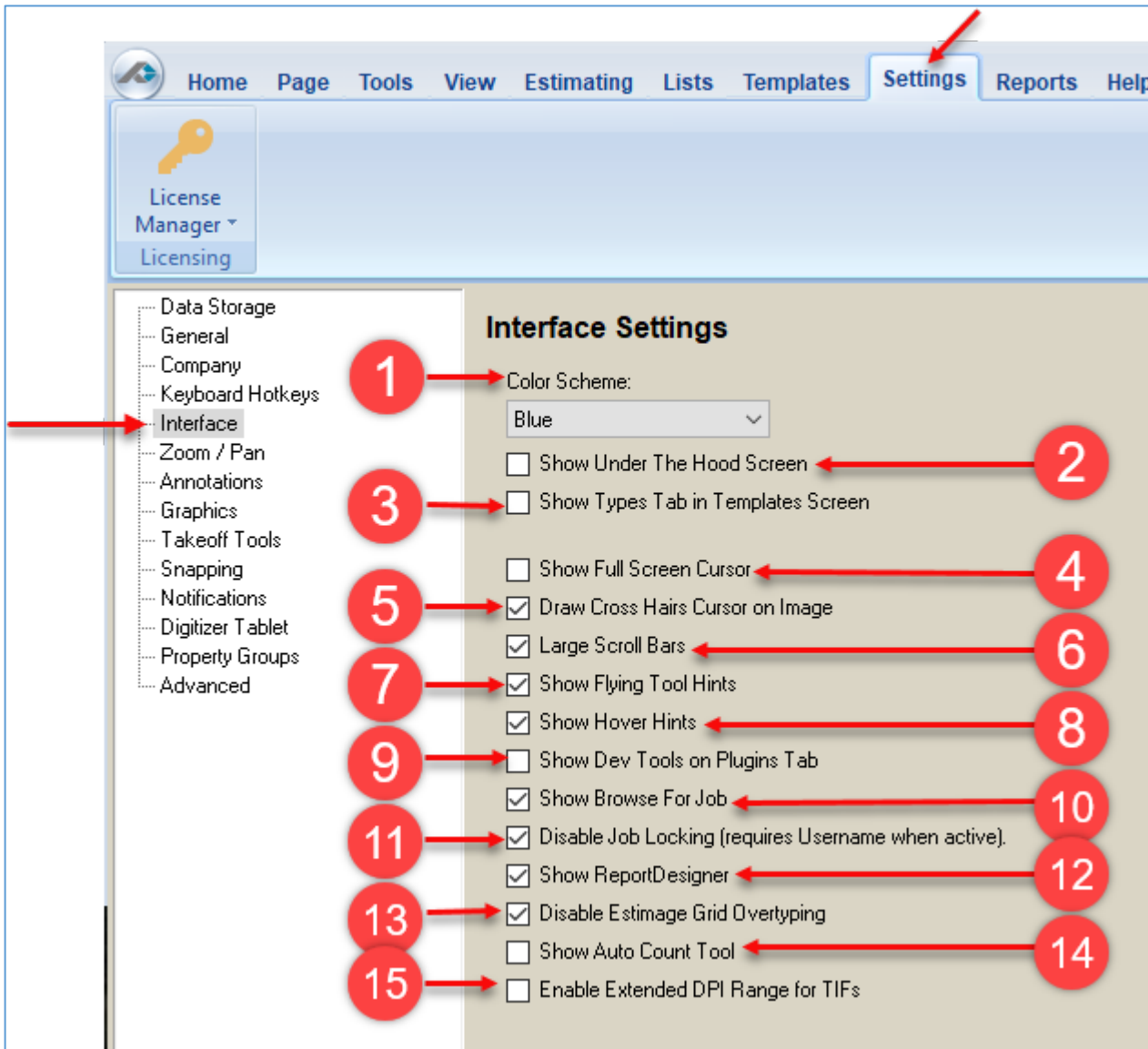

Figure 51-A

1. The **Color Scheme** provides three color schemes: blue, silver, and black (Fig. 51-B).

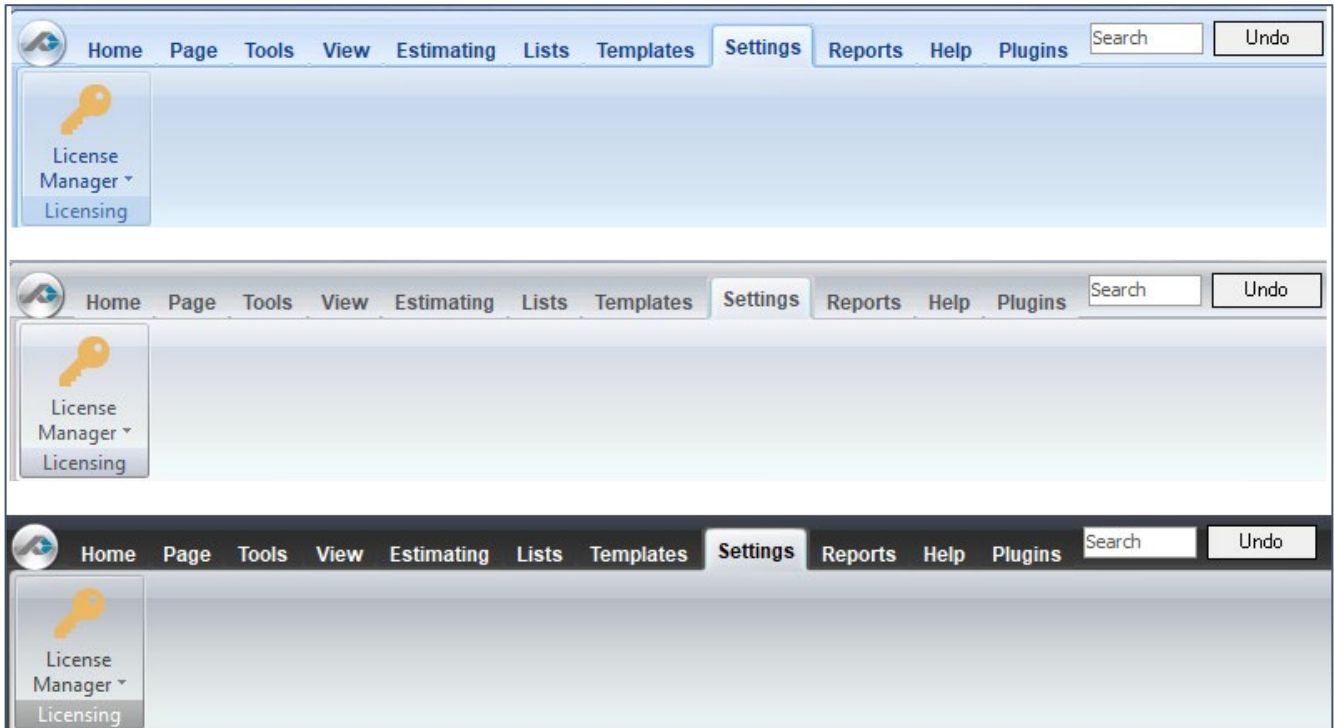

Figure 51-B

2. The **Show Under The Hood Screen** displays the UTH (Under-The-Hood) tab after a password is entered (Fig. 51-C). Going "Under-The-Hood" allows the programmer to link to PlanSwift software to develop applications that work with PlanSwift. Under-The-Hood provides a programmer the capability to link to PlanSwift software to develop applications that work with PlanSwift. This tab is used for accessing the Application Programming Interface (API) and is for developers only. PlanSwift's technical support team does not support going under-the-hood. You are on your own! Additional API information is available [here](#). We recommend that data be backed up before venturing into the API.

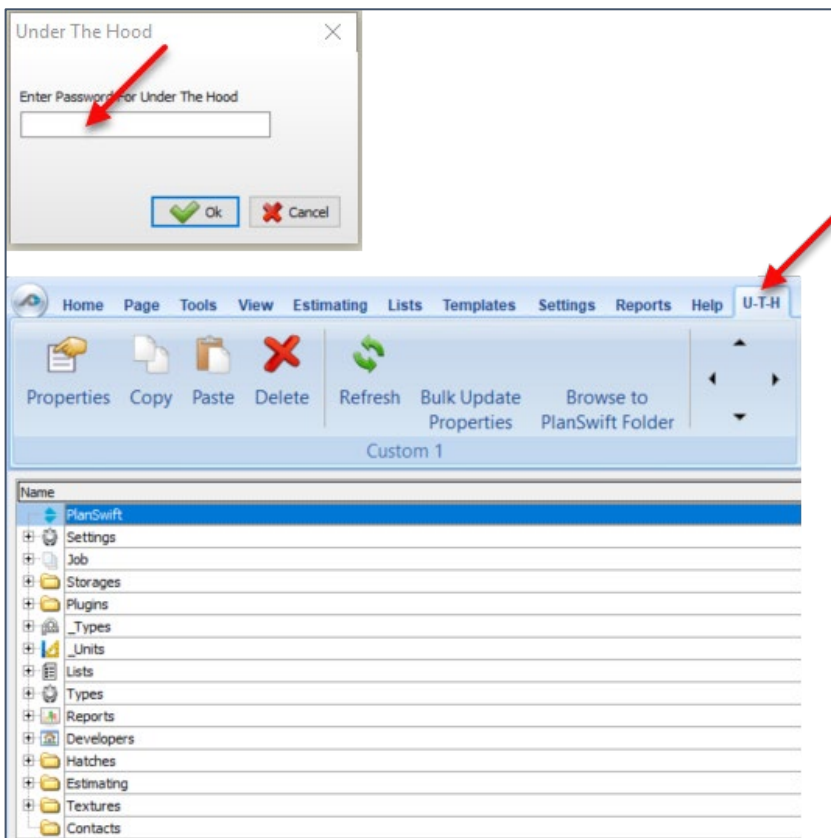
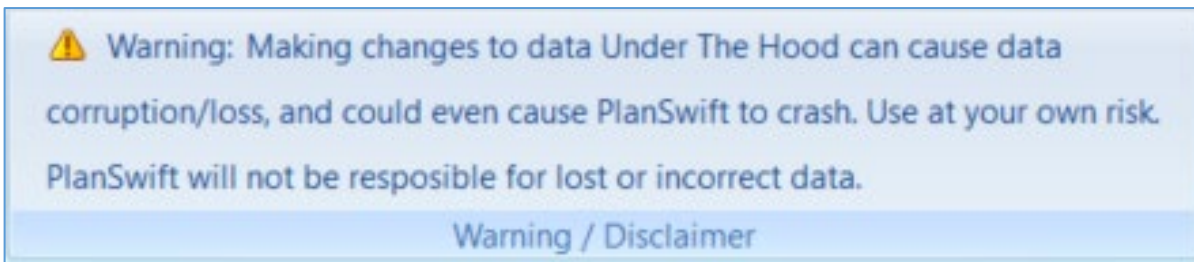

Figure 51-C

- The **Show Types Tab in Templates Screen** (Fig. 51-D) displays the **Types** tab in the **Templates** screen. The **Types** tab allows you to make universal changes to default items. PlanSwift recommends [additional training](#) to use this feature.

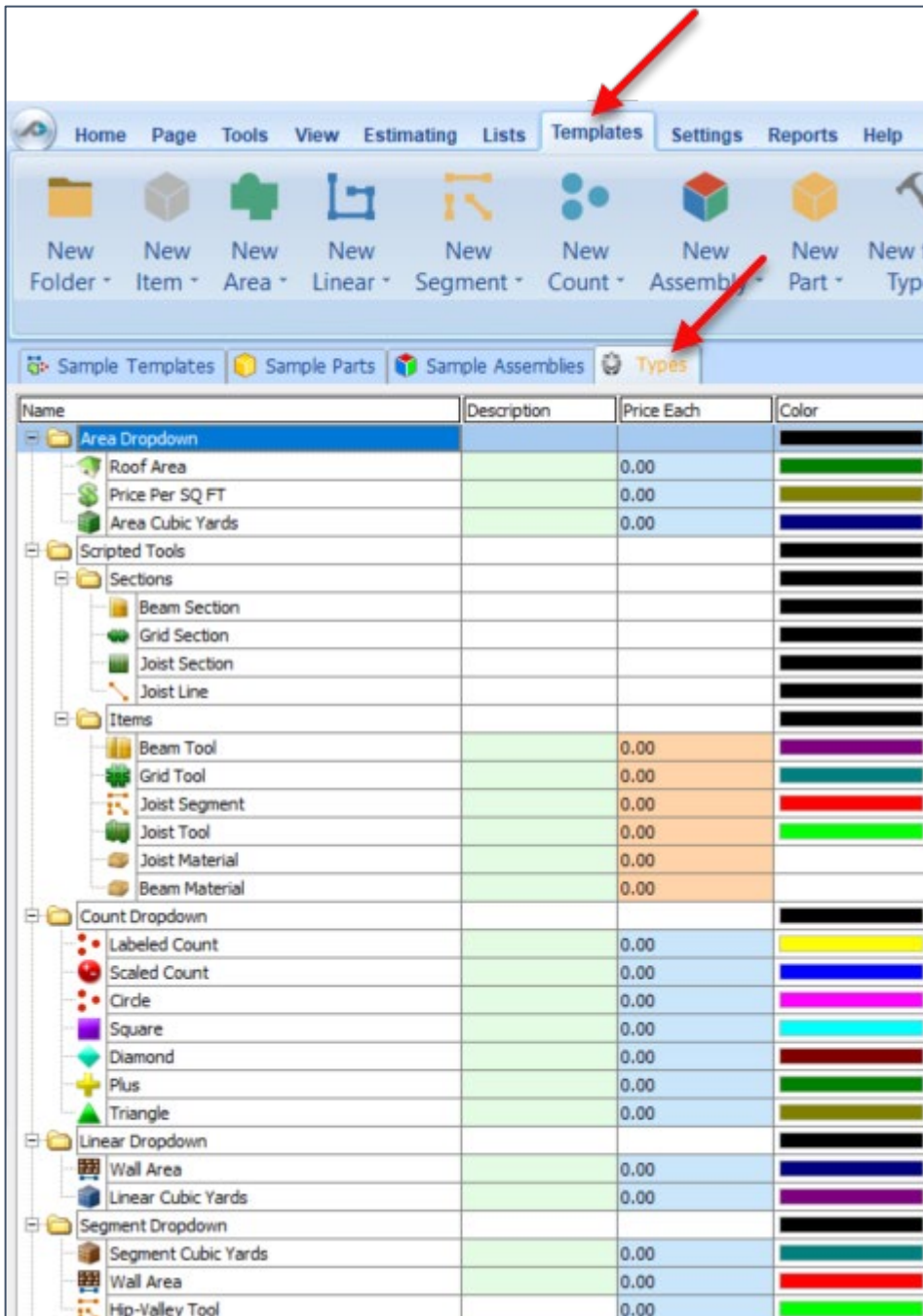

Figure 51-D



- The **Show Full Screen Cursor**, when checked, causes the cursor crosshairs to extend across the page's entire area. The upper diagram shows just the cursor; the lower diagram shows the full-screen cursor (Fig. 51-E).

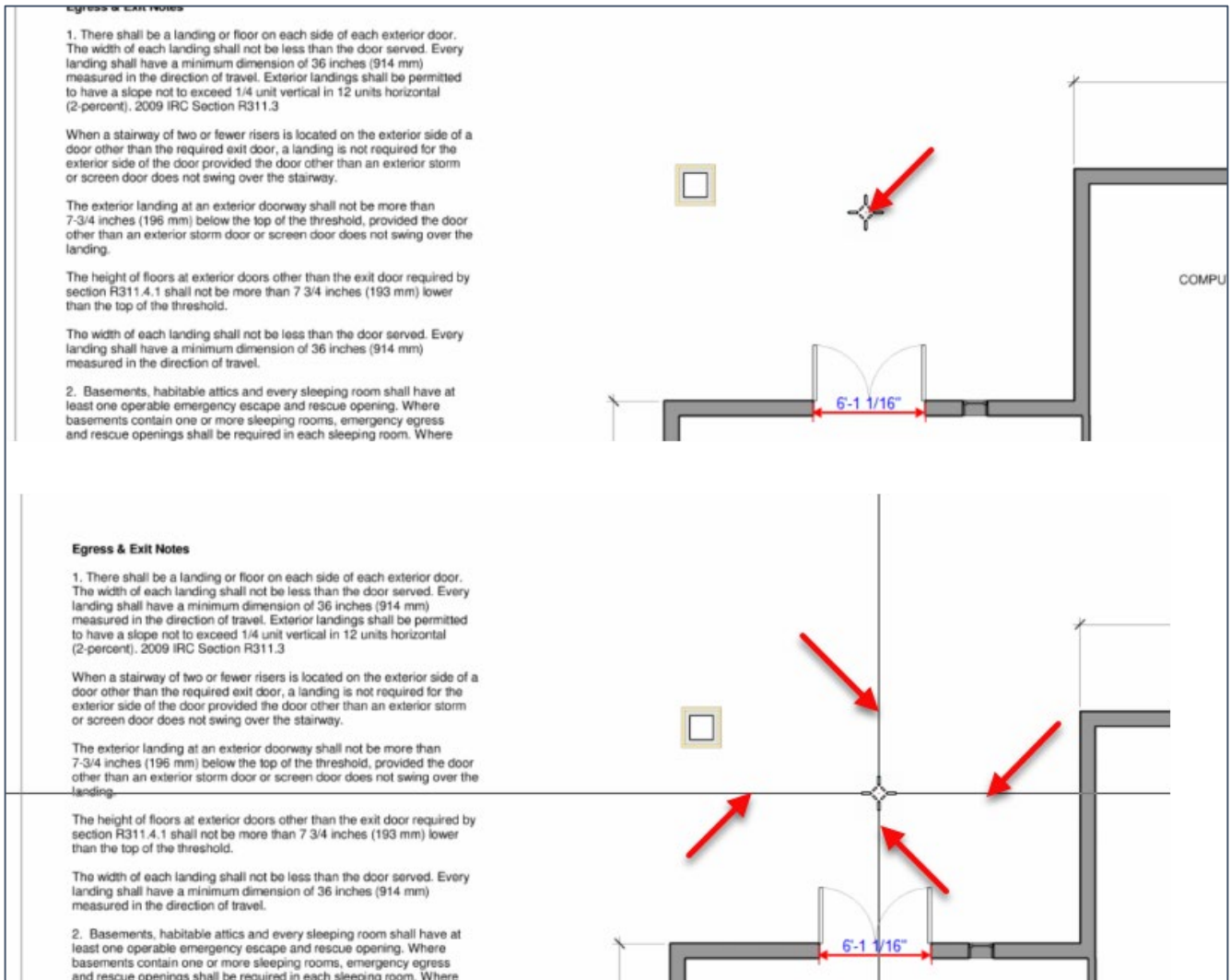

Figure 51-E

5. The **Draw Cross Hairs Cursor on Image** is not Implemented.
6. The **Large Scroll Bars**, when checked, become twice as wide (Fig. 51-F).



Figure 51-F

7. The **Show Flying Tool Hints**, when checked, shows the flying tool hints (Fig. 51-G). Hover the cursor over the tool to see the hint.

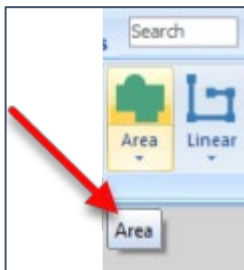

Figure 51-G

8. The **Show Hover Hints**, when checked, shows the takeoff hints when you hover the cursor over a takeoff (Fig. 51-H).

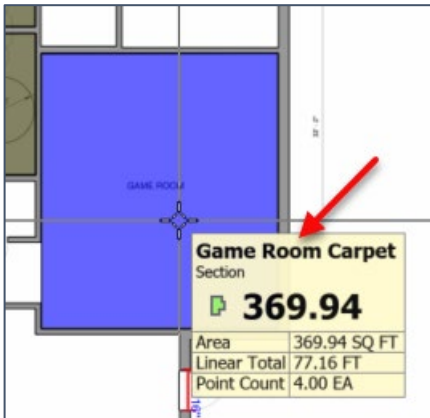

Figure 51-H

9. The **Show Dev Tools on Plugins Tab**, when checked, shows the developer tools (**Export Plugin Package**) button on the **Plugins** tab (Fig. 51-I). This tool is for developers only and are not included in PlanSwift support.

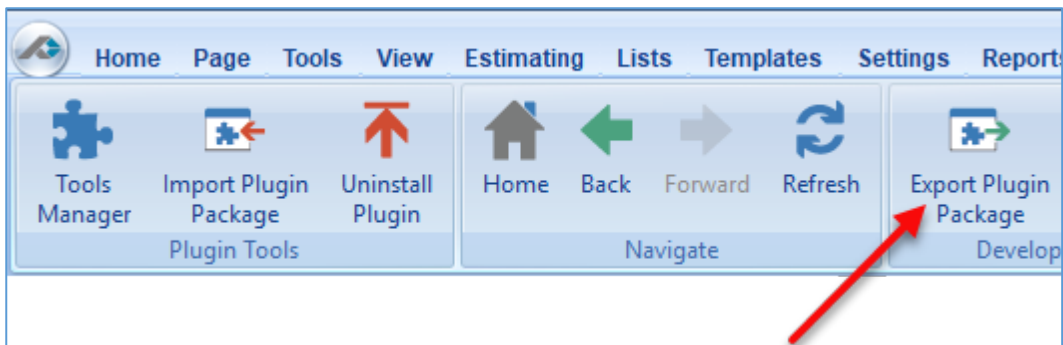

Figure 51-I

10. The **Show Browse For Job**, when checked, displays a **Browse** button (#a in Fig. 51-J) on the **Open Job** window (#b) that allows you to navigate (using the **Select Job Folder** window, #c) to other locations where jobs are stored.

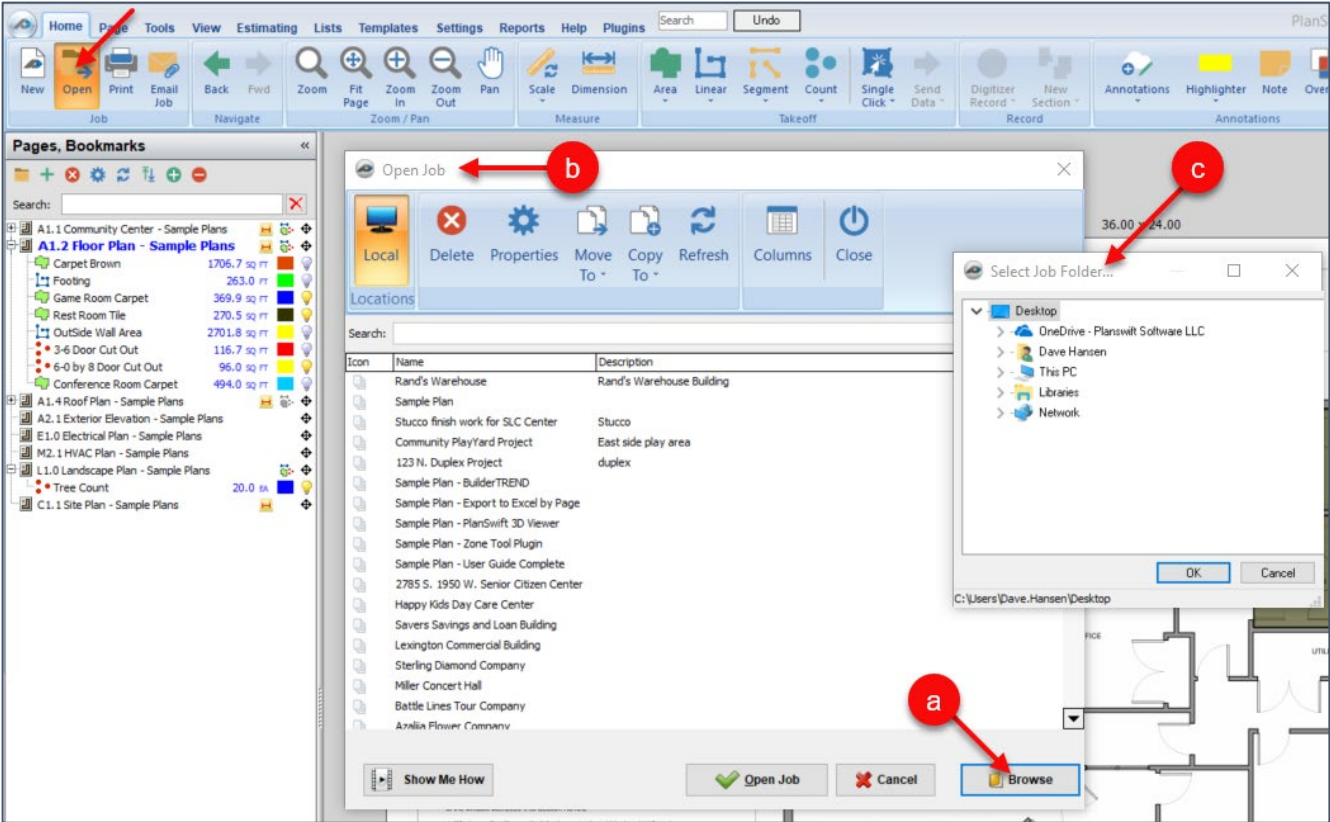

Figure 51-J

- 11. The **Disable Job Locking** has not been implemented.
- 12. The **Show ReportDesigner**, when checked, displays the **Report Designer** button on the **Reports** tab (Fig. 51-L). Before the button is displayed, you are asked to confirm that this is an advanced tool that may require [additional training](#) that is not covered under the annual maintenance agreement.

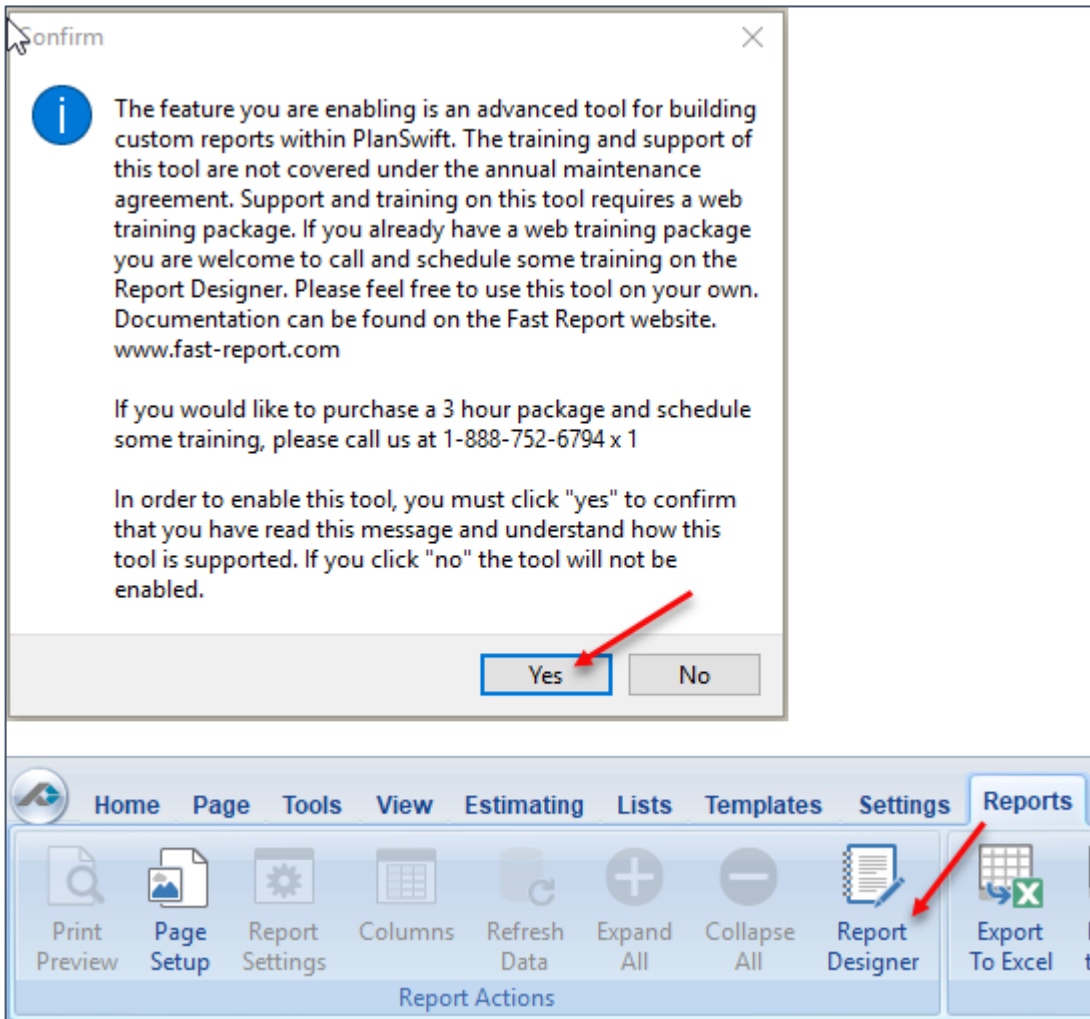

Figure 51-L

- 
13. The **Disable Estimate Grid Overtyping**, when checked, does not delete existing text in an estimating field when the field is edited. When it is not checked, any text in a field is deleted and replaced by newly entered text.
  14. The **Show Auto Count Tool**, when checked, shows the **Auto Count** tool in the **Takeoff** group on the **Home** tab ribbon-bar (Fig. 51-M).

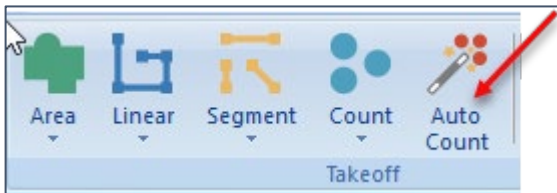

Figure 51-M

15. The **Enable Extended DPI Range for TIFs**, when checked, enables higher ranges of DPI to be entered when pulling in plans.

## Configuring Language and Measurement Type Defaults

The **General** option under the **Settings** tab on the **Main** ribbon-bar menu allows you to set your **Language** (Deutsch, English, Espanol, Italiano, or Francais) and **Measurement Type** (English or Metric) defaults (Fig. 51-N).

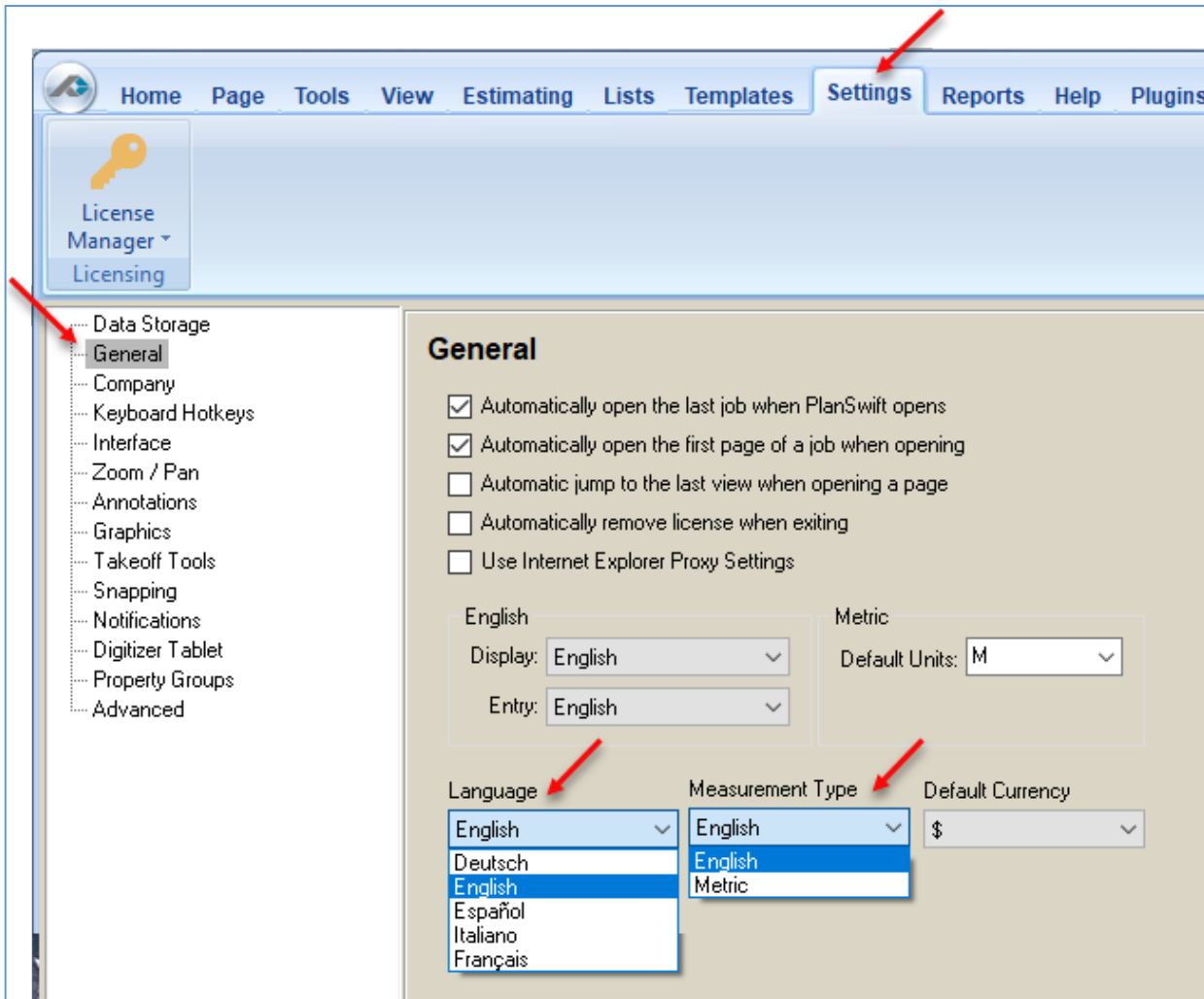

Figure 51-N

## Managing Data Storage

PlanSwift saves jobs to your local drive by default to this location:

C:\Program Files (x86)\PlanSwift10\Data\Storages\Local\Jobs

The **Data Storage** option under the **Settings** tab on the **Main** ribbon-bar menu allows you to setup **New Storage Locations** (Fig. 51-O). You can go to the [New Data Storage](#) article in our PlanSwift Knowledge Base for further instructions, or you can call PlanSwift for assistance (888-752-6794, Ext. 2).

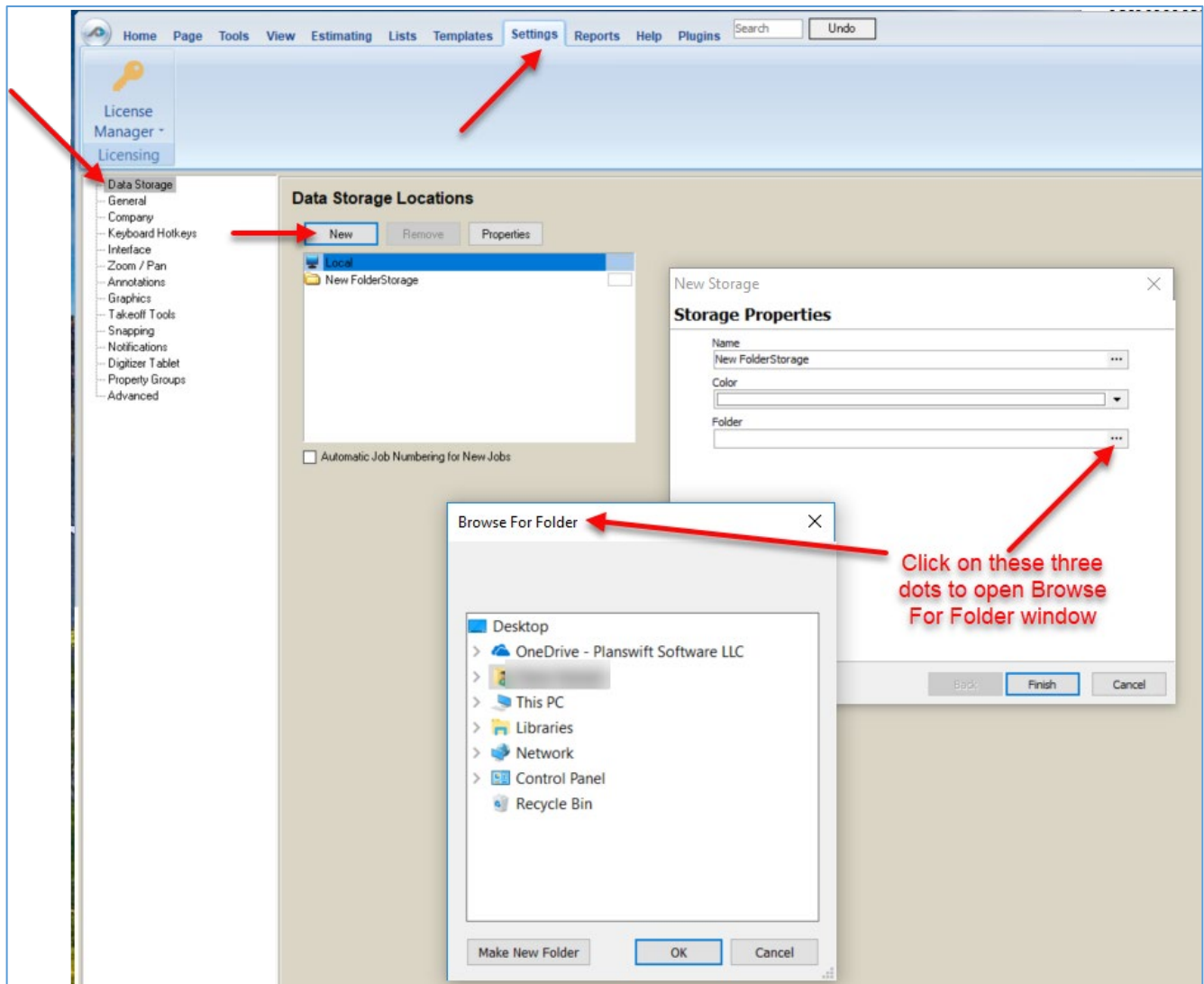

Figure 51-0



## Right-Click Menus

PlanSwift includes numerous right-click menus to provide greater functionality and shortcuts that help to do takeoffs and estimating more easily. Examples of them are shown below:

1. Right-click initiated on a tab (Fig 52-A):

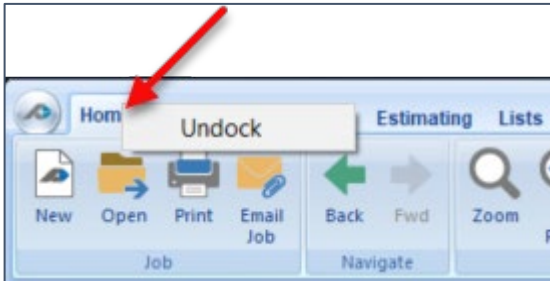

Figure 52-A

Note: The **Undock** right-click menu can only be initiated on the **Estimating, Lists, Templates, Settings, Reports, Help,** and **Plugins** tabs. It cannot be initiated on **Home, Page, Tools,** or **View** tabs.

2. Right-click initiated on blank space of page canvas (Fig. 52-B):



Figure 52-B

3. Right-click initiated on a takeoff area (Fig. 52-C):

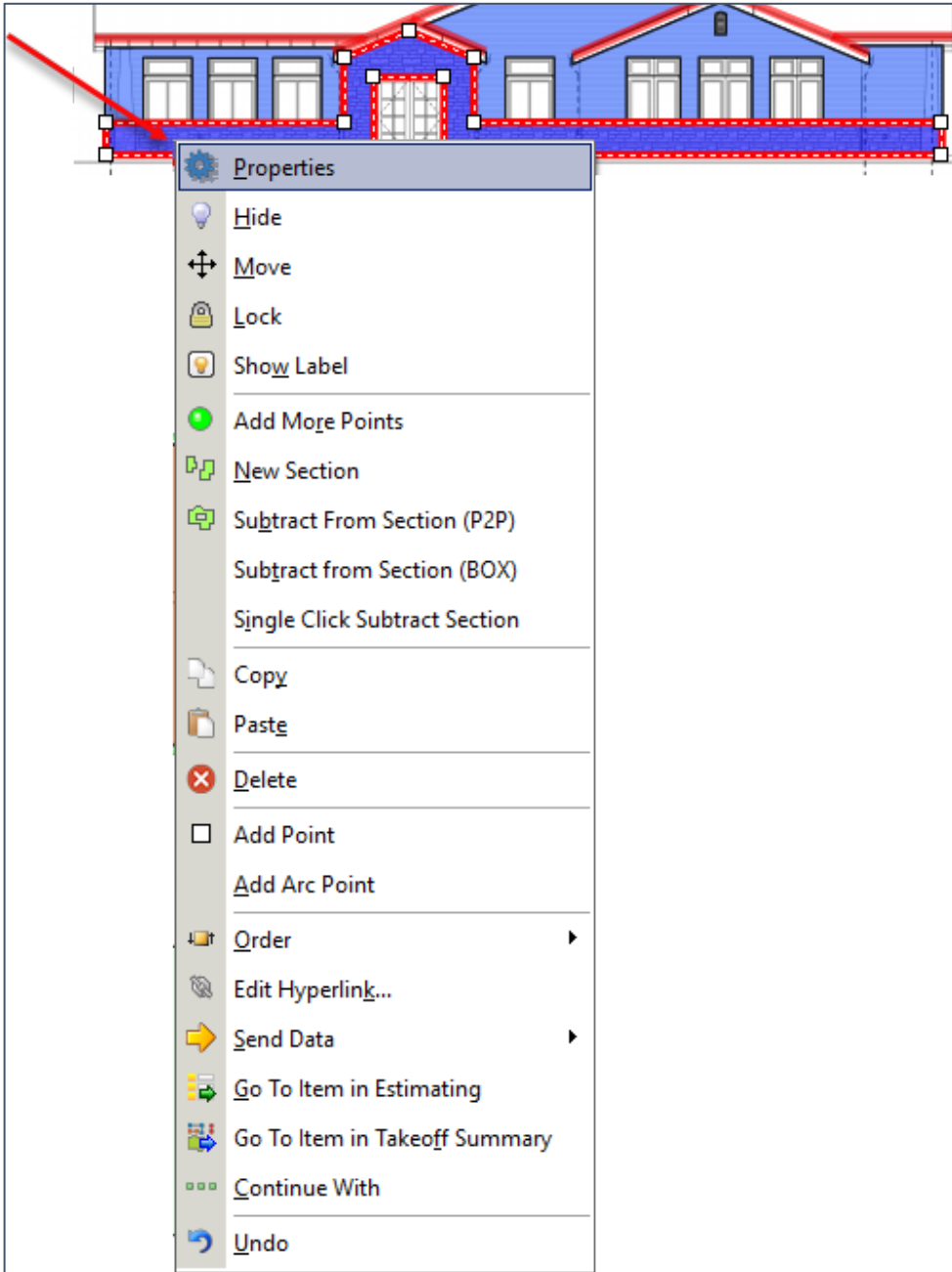

Figure 52-C

4. Right-click initiated on **Pages, Bookmarks, Notes, Takeoff Summary, Templates, Parts, Attachments, and Inputs** windows (Fig. 52-D):

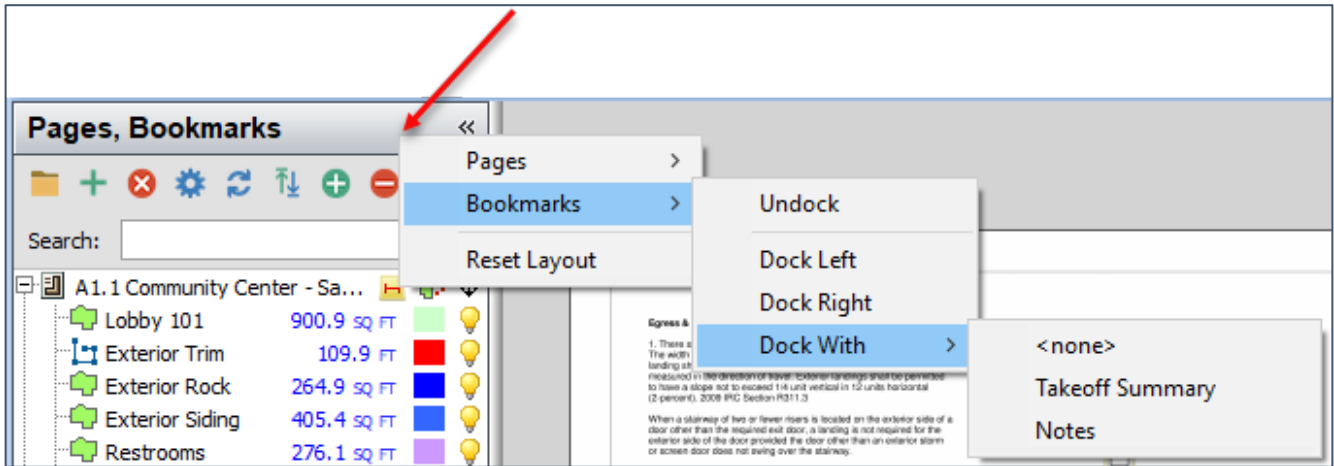

Figure 52-D

5. Right-click initiated on a page in **Pages, Bookmarks** window (Fig. 52-E):

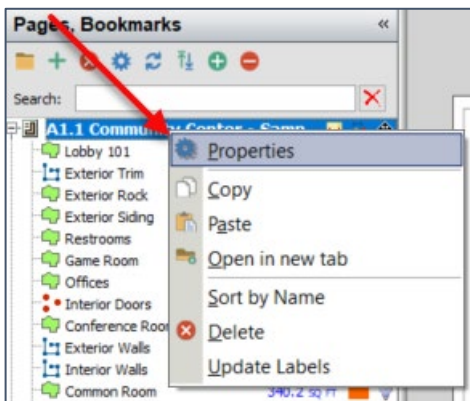

Figure 52-E

6. Right-click initiated on a takeoff item in **Pages, Bookmarks** window (Fig. 52-F):

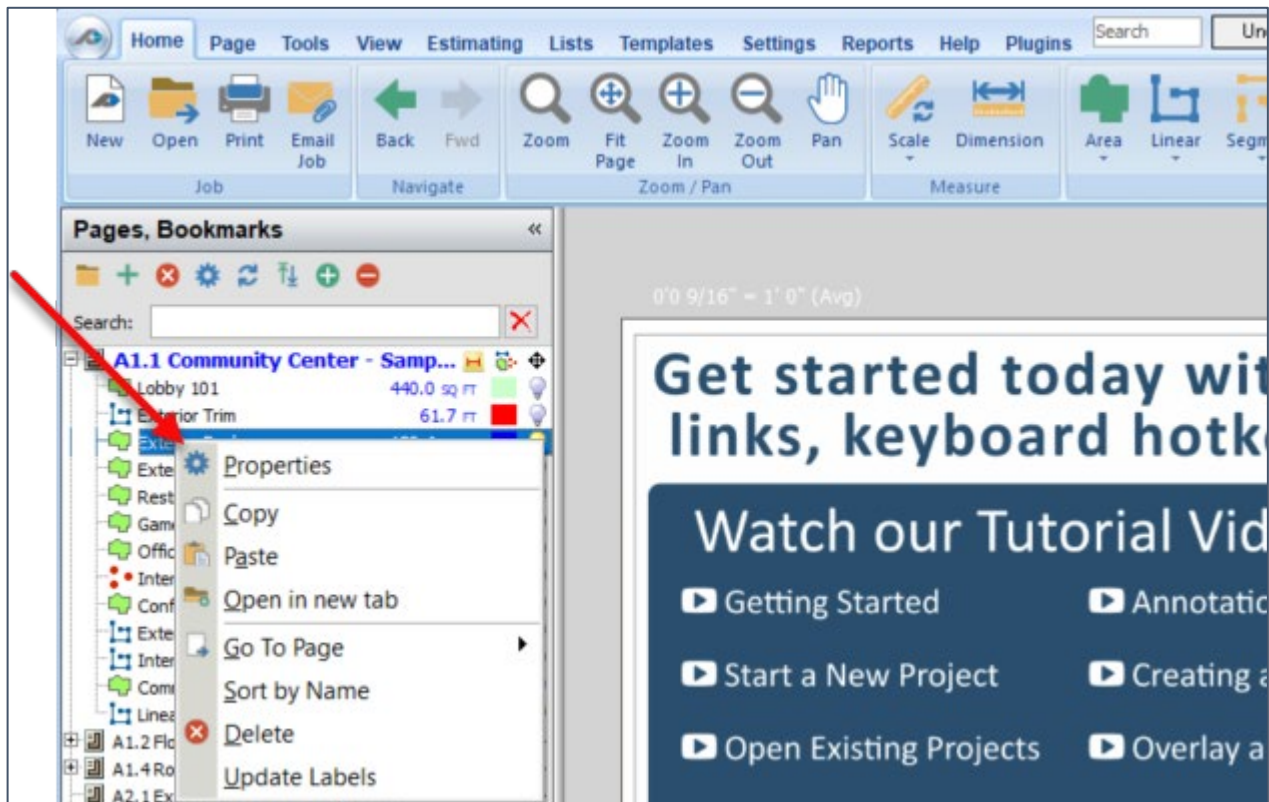

Figure 52-F

7. Right-click initiated on **Snap** (Fig. 52-G):

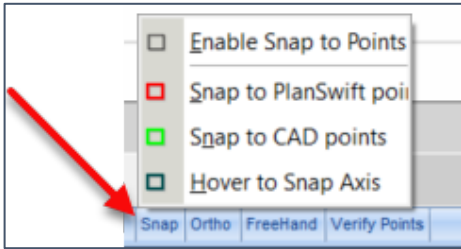

Figure 52-G

8. Right-click initiated on **AutoScroll** (Fig. 52-H):

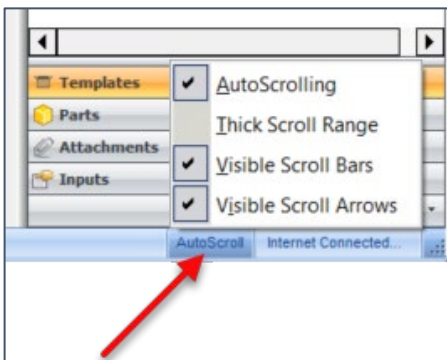

Figure 52-H

9. Right-click initiated on **Takeoff Summary** takeoff (Fig. 52-I):

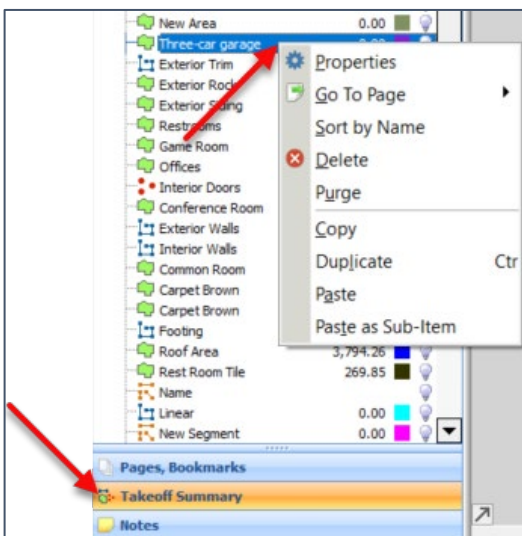

Figure 52-I

10. Right-click initiated on a layout in **Estimating Layouts** window (Fig. 52-J):

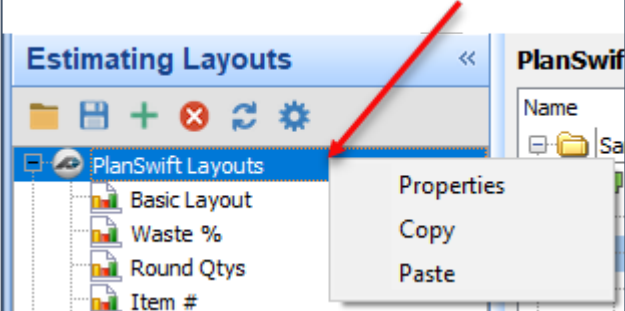

Figure 52-J

11. Right-click initiated on an **Estimating** item in the layout (Fig. 52-K):

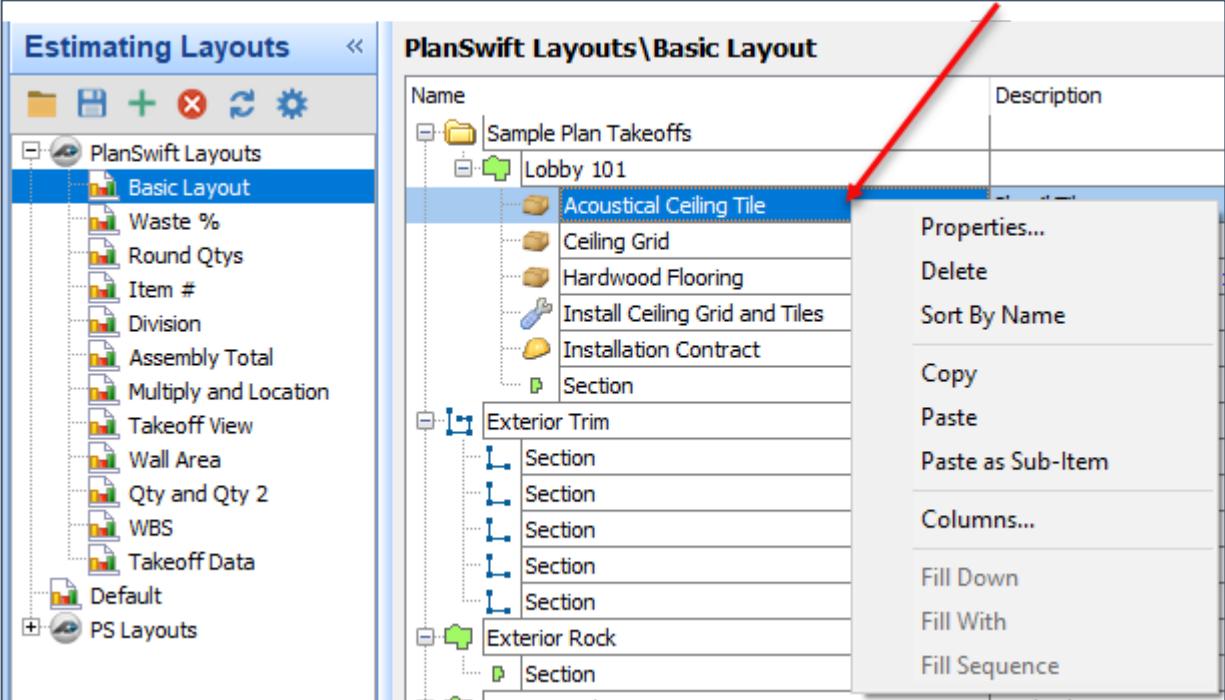
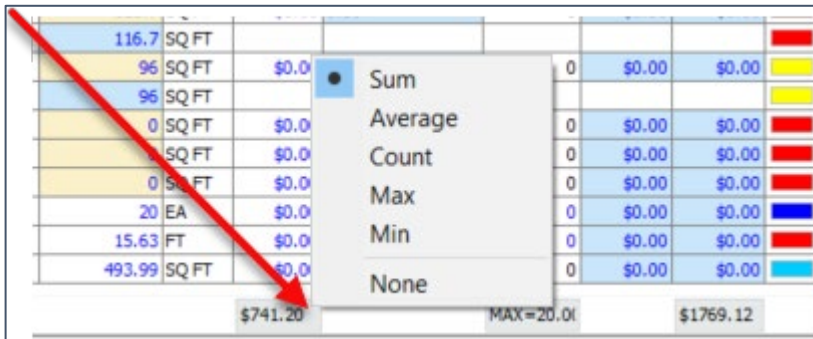

Figure 52-K

12. Right-click initiated on an Estimating total (Fig. 52-L):



116.7	SQ FT						
96	SQ FT	\$0.0		0	\$0.00	\$0.00	
96	SQ FT						
0	SQ FT	\$0.0		0	\$0.00	\$0.00	
	SQ FT	\$0.0		0	\$0.00	\$0.00	
0	SQ FT	\$0.0		0	\$0.00	\$0.00	
20	EA	\$0.0		0	\$0.00	\$0.00	
15.63	FT	\$0.0		0	\$0.00	\$0.00	
493.99	SQ FT	\$0.0		0	\$0.00	\$0.00	
		\$741.20		MAX=20.00		\$1769.12	

Figure 52-L

13. Right-click initiated on an **Estimating Name** column (Fig. 52-M):

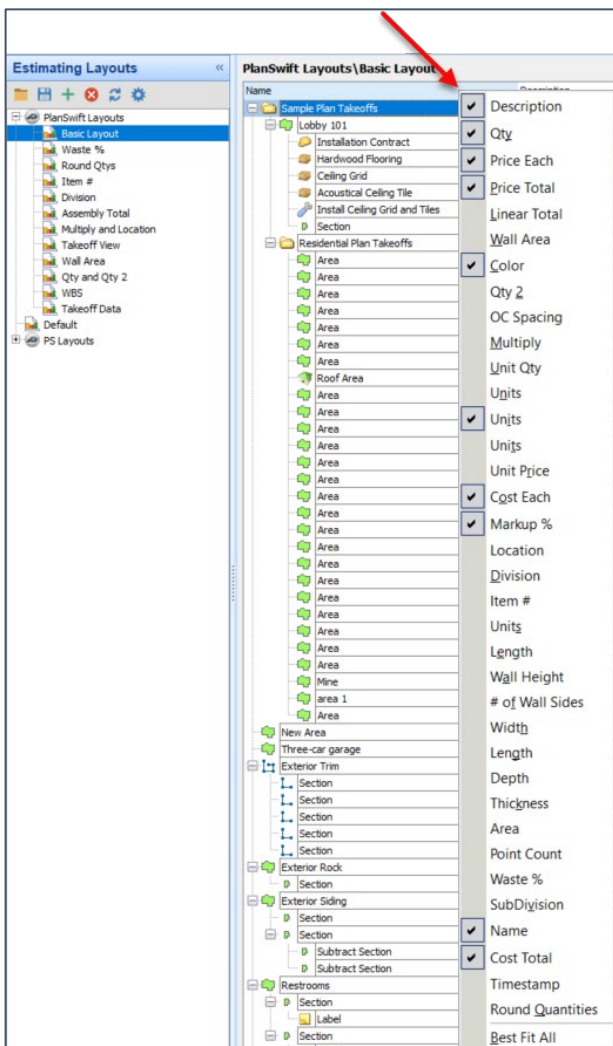

Estimating Name

- Description
- Qty
- Price Each
- Price Total
- Linear Total
- Wall Area
- Color
- Qty 2
- OC Spacing
- Multiply
- Unit Qty
- Uqjts
- Unjts
- Units
- Unit Price
- Cgst Each
- Markup %
- Location
- Division
- Item #
- Units
- Length
- Wall Height
- # of Wall Sides
- Width
- Length
- Depth
- Thickness
- Area
- Point Count
- Waste %
- SubDivision
- Name
- Cost Total
- Timestamp
- Round Quantities
- Best Fit All

Figure 52-M

14. Right-click initiated on a **Templates** window template (Fig. 52-N):

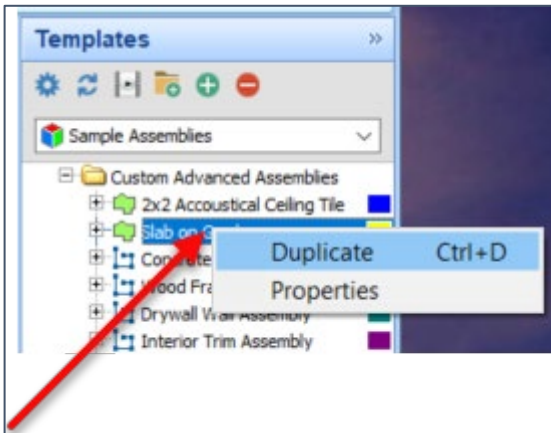

Figure 52-N

15. Right-click initiated on a **Lists** window list (Fig. 52-O):

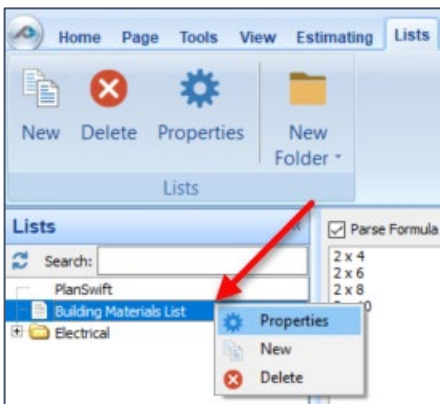

Figure 52-O



16. Right-click initiated on a **Templates** assembly (Fig. 52-P):

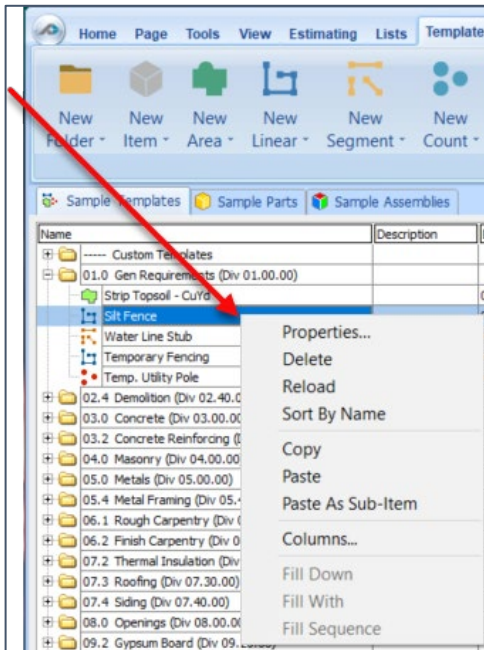

Figure 52-P

17. Right-click initiated on a **Templates** Sample Assembly **Name** column (Fig. 52-Q):

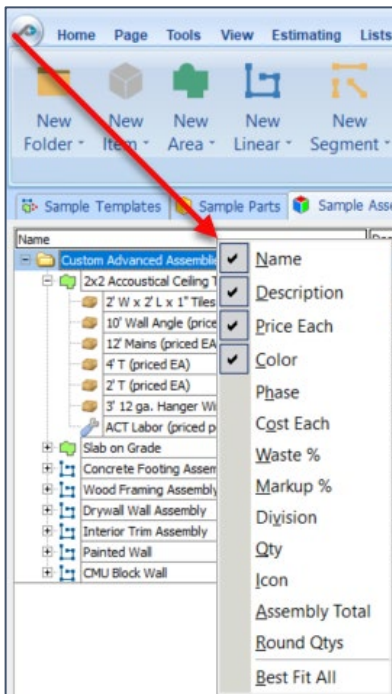

Figure 52-Q

18. Right-click initiated on any tab inside of the **Templates** tab (Fig. 52-R):

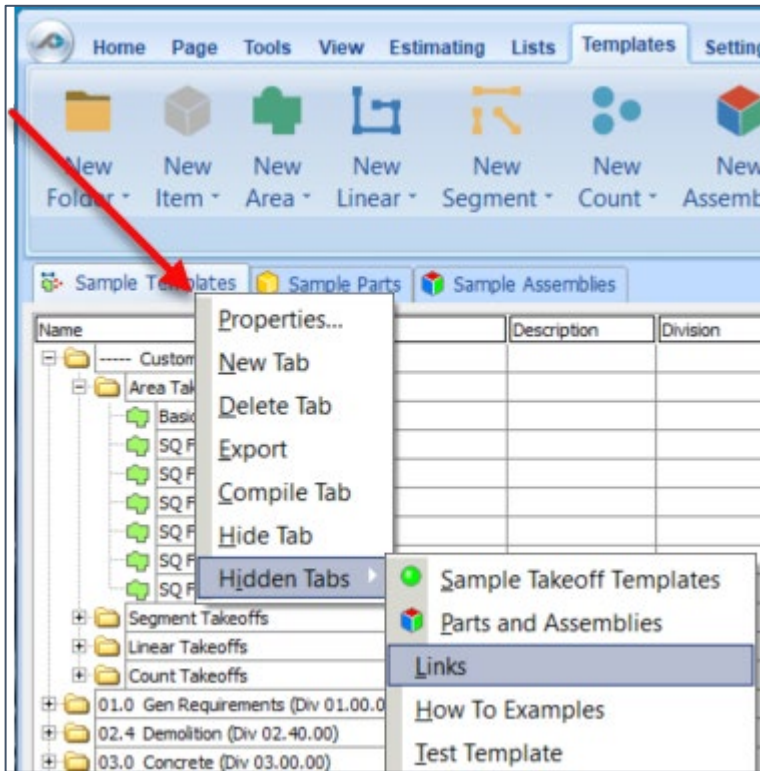

Figure 52-R

19. Right-click initiated on a **Report Layouts** report (Fig. 52-S):

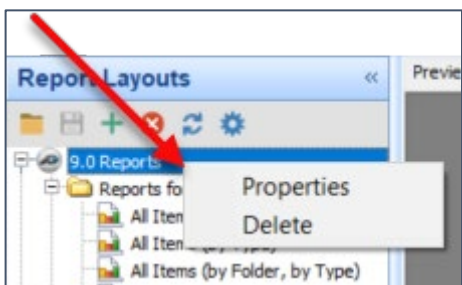

Figure 52-S

# Developer Overview

PlanSwift includes a powerful Scripting Interface feature that allows you to create your own ribbon-bar buttons and assign scripts to them.

**PlanSwift does not provide technical support or advanced training for the Developer Tools or the Tools Manager.** This overview is for developer use only. You are on your own!

Before using **Developer Tools** and the **Tools Manager** be sure to back up your jobs. To use the Scripting Interface, follow the steps below.

1. Click on **Plugins** on the PlanSwift Main menu ribbon-bar (Fig. 53-A).

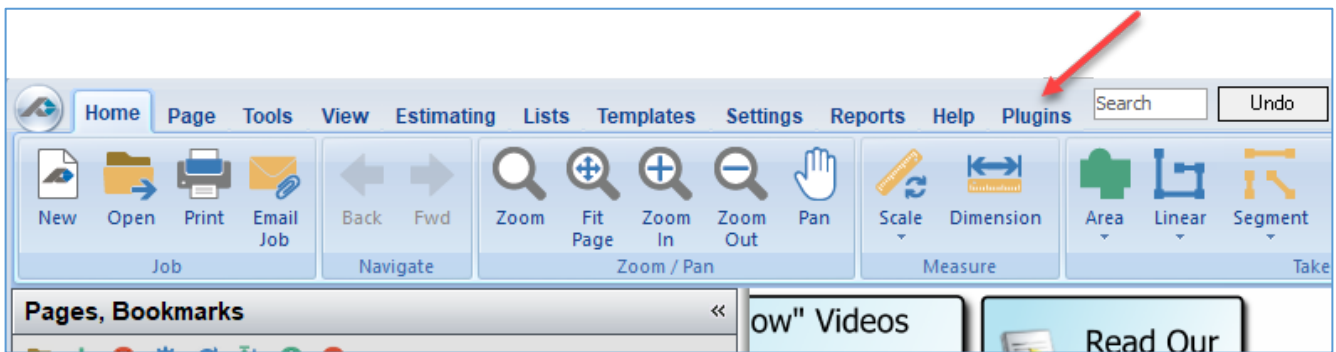

Figure 53-A

2. Click on the **Tools Manager** on the **Plugins** ribbon-bar menu (Fig. 54-B).

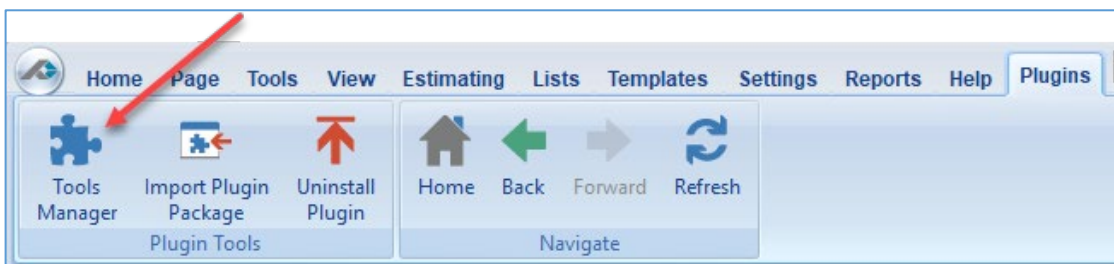

Figure 53-B

3. In the **Tools Manager** window (Fig. 53-C), click on the green plus (+). Note that the yellow folder icon allows a new folder to be created for storage of plugins. The blue gear icon allows the viewing of properties for any plugin in the window below. The red "X" icon allows for a plugin to be deleted. The green triangular icon allows a selected plugin to be executed.

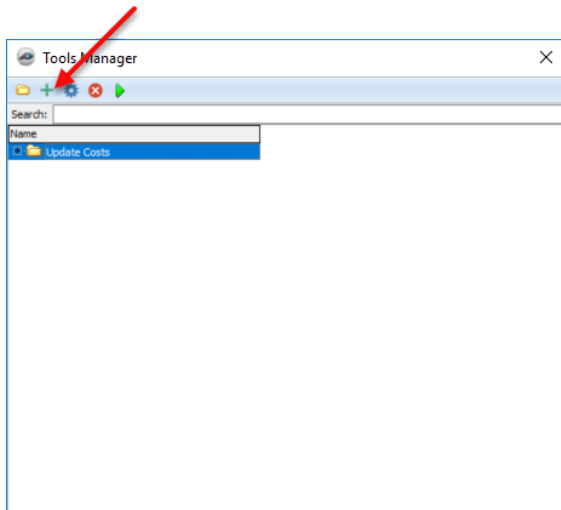

Figure 53-C

4. In the **Properties - [New Plugin]** window, give the new plugin a name, such as "My Plugin" or whatever name you choose for the new plugin (Fig. 53-D).

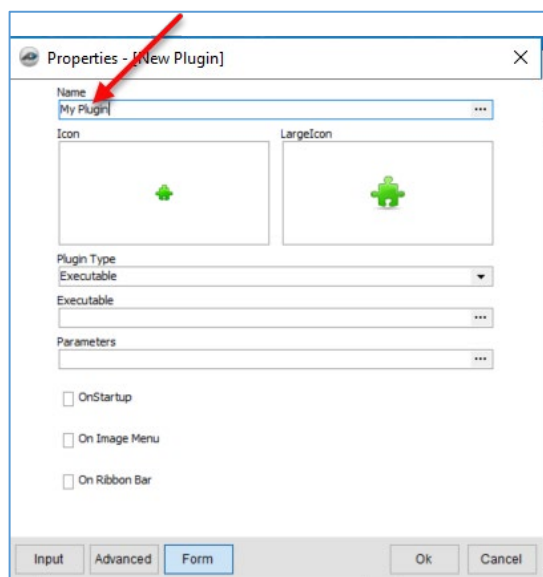

Figure 53-D

5. Select the **Plugin Type** by clicking on the **Plugin Type** selection arrow and then selecting **Script Code** from the drop-down menu (Fig. 53-E).

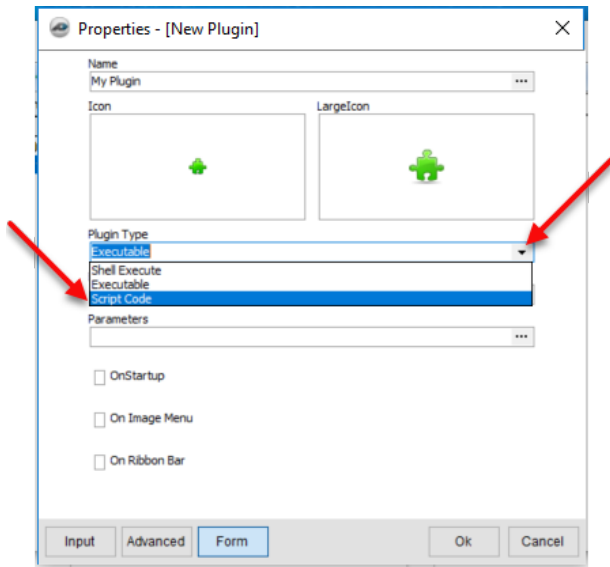

Figure 53-E

6. The **Plugin Type** is now displayed as **Script Code** (#a in Fig. 53-F). Double-clicking on the **Icon** (#b) or the **Largelcon** (#c) allows the selection of a small **Icon** or a **Largelcon**.

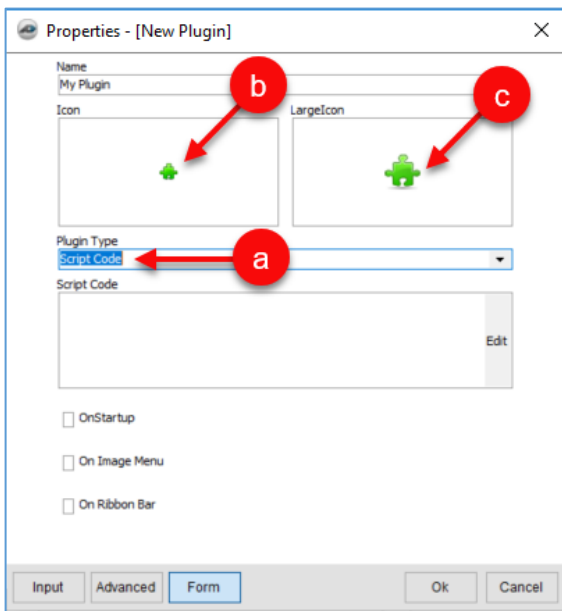

Figure 53-F

7. You can select where you want the new icon to appear (Fig. 53-G):
- a. **OnStartup** (executes the plugin upon PlanSwift startup)
  - b. **On Image Menu** (adds your plugin to the right-click menu)
  - c. **On Ribbon Bar** (adds your plugin to the ribbon-bar)
  - d. **Ribbon Tab** (specifies a default tab for PlanSwift and is not customizable)
  - e. **Ribbon Group** (Specifies the ribbon group and is customizable).

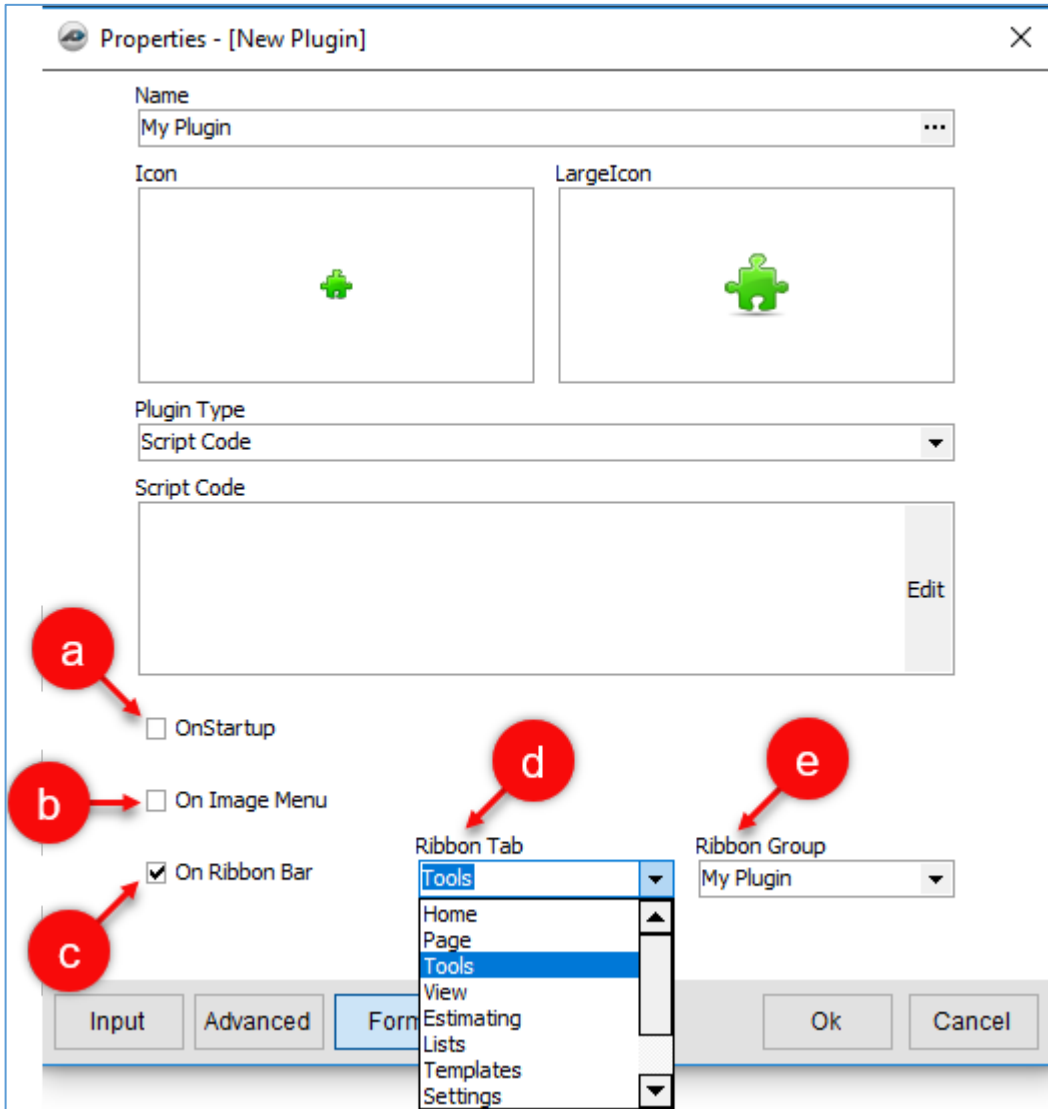

Figure 53-G

8. Click on the **Tools** tab on the **Main** Ribbon-bar menu, and you will see the new **"My Plugin"** plugin displayed in the **Takeoff Item** group (Fig. 53-H).

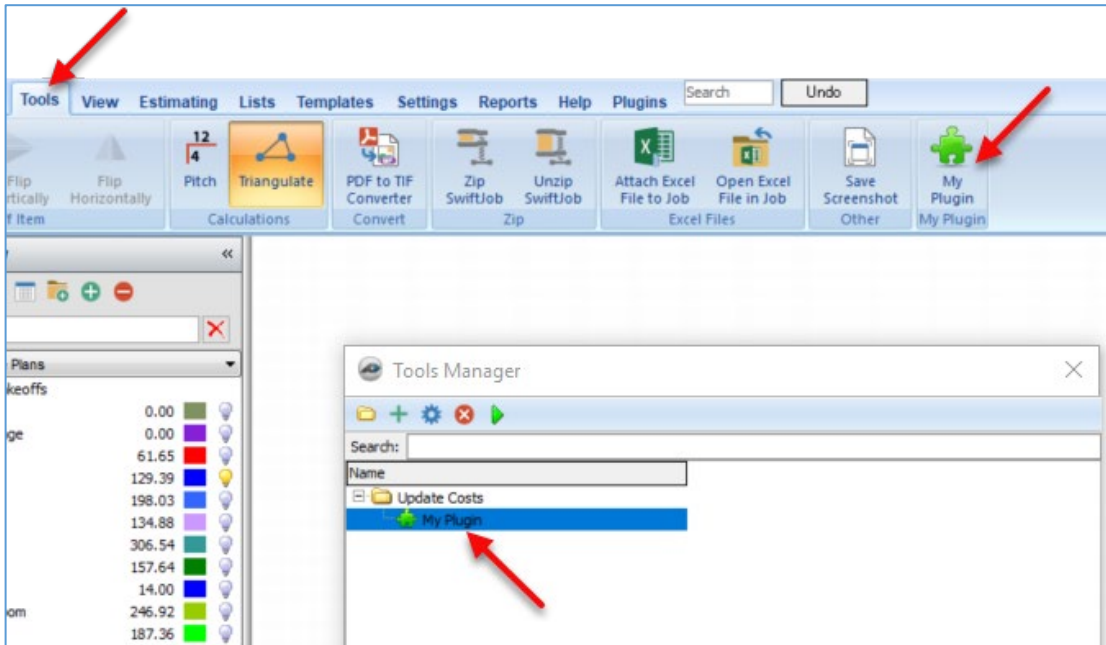

Figure 53-H

9. Double-click on **My Plugin** in the **Tools Manager** window to re-open the **Properties - [My Plugin]** window (Fig. 53-I). Click on **Edit**.

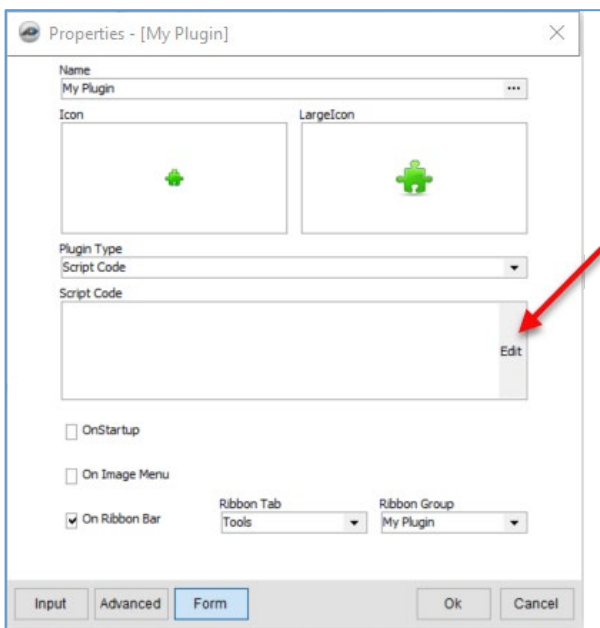

Figure 53-I

10. This opens the **Script Code - Script Editor** window (Fig. 53-J). The large **Script Editor** window on the right is where the plugin code is written. The **Code Explorer** window will list variables and procedures as they are coded into the **Script Editor** window. The **Help** window contains the **COM Object Model** and **Scripting** selections available to use in the **Script Editor** window. Clicking on the "+" symbol opens the folder and subfolders. Click on the "+" left of **COM Object Model**, then click on the "+" left of the **IPlanswift** folder.

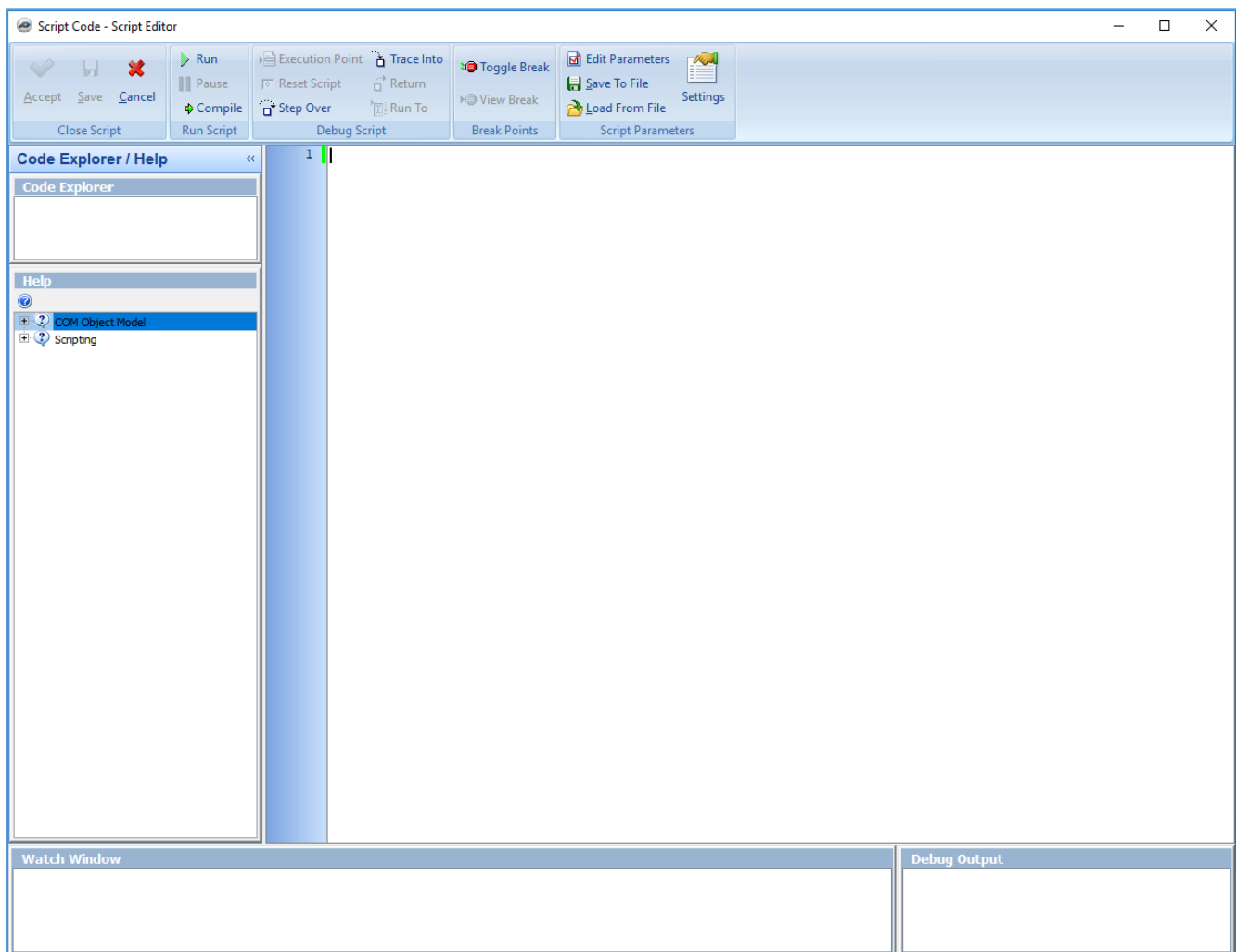

Figure 53-J



11. Clicking on **CurrentVersion** (#a of Fig. 53-K), then clicking on the question mark (#b), opens the **CurrentVersion** window (#c), which provides the name of the **Declaration** and its description with a **Source Code** example. Source code may be copied and pasted into the **Script Editor** window and then modified as needed, or the **CurrentVersion** selection can be double-clicked on and will appear in the **Script Editor** window at the cursor's last position. The **Close Script**, **Run Script**, **Debug Script**, **Break Points**, and **Script Parameters** ribbon-groups provide the tools needed for scripting.

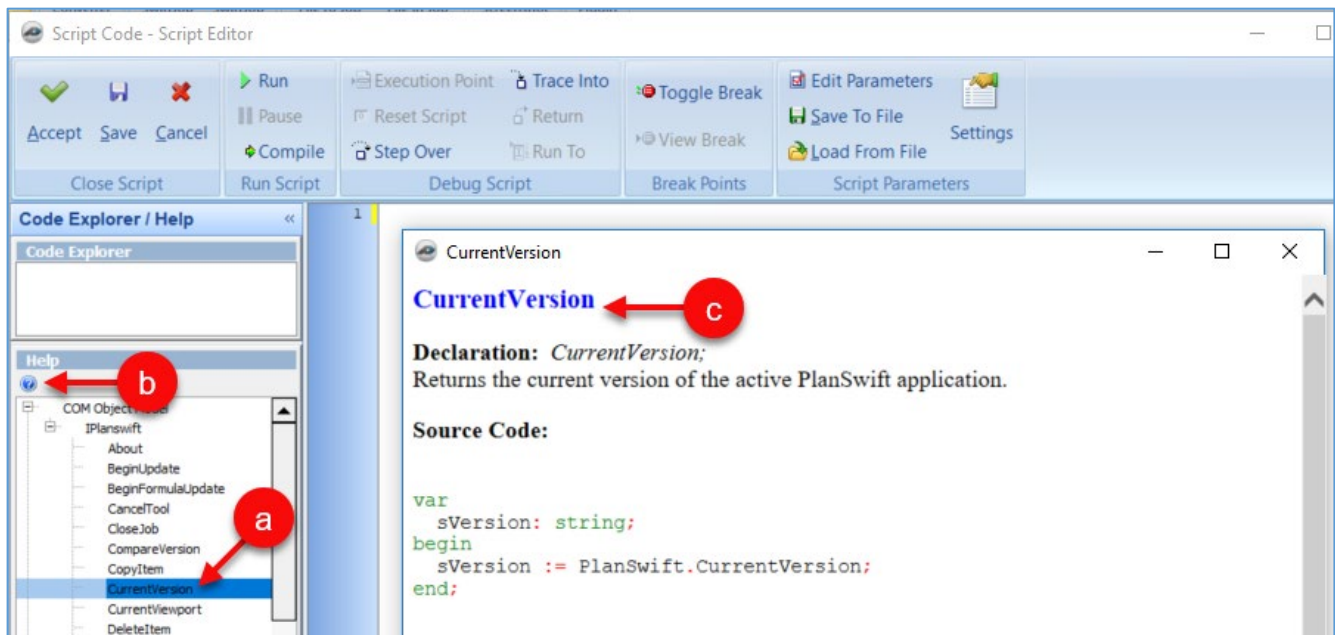

Figure 53-K

---

# Managing PlanSwift Licenses

## Activation and How Licenses Work

When you first download PlanSwift, you are given a customer number and pin number (through email) that will give you full and free access to PlanSwift features for two weeks. After that period, PlanSwift reverts to a viewer-only mode unless you contact PlanSwift and purchase a license for the software. Upon payment and activation, PlanSwift is restored to its full functionality.

On January 15, 2019, PlanSwift changed the activation procedure for its software. For those using PlanSwift 10.2 and newer releases, activation requires you to use an email address and a password to login. For those using PlanSwift 10.1 and previous releases, activation requires you to use a Customer # and Pin #. Click [here](#) to view the [knowledgebase article](#) that may be able to assist you. Some situations may require that you call PlanSwift Technical Support (1-888-752—6794, Ext. 2). They will be happy to assist you.

If you have PlanSwift installed on more than one computer but have only one license (or you have fewer licenses than you have computers that PlanSwift is installed on), then the PlanSwift license can be removed (deactivated) from an activated computer and then reactivated on a different computer. PlanSwift requires reactivation at least every ninety days and can be modified to be a shorter reactivation period within the [My Account](#) customer portal. The deactivated PlanSwift software will then have **Viewer**-only mode capabilities. The software title bar to the right of the ribbon-bar tab shows whether you are in **Viewer** mode or not (Fig. 54-A).

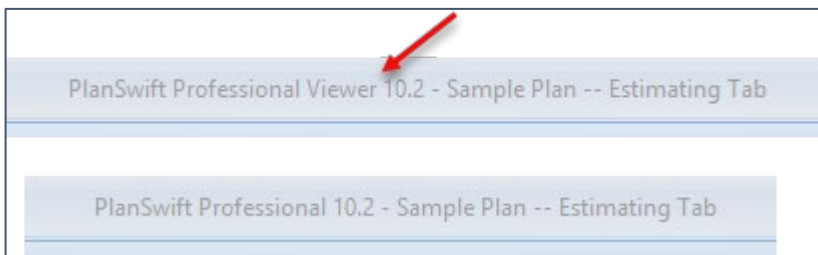

Figure 54-A

# Activating PlanSwift

To activate PlanSwift (see Fig. 54-B):

1. Start PlanSwift.
2. Click on the **Help** tab.
3. Click on **Activate PlanSwift Professional**.
4. The **Activate Product** window appears.
5. Enter your **Email Address**.
6. Enter your **Password**.
7. Click on **Activate Now**.

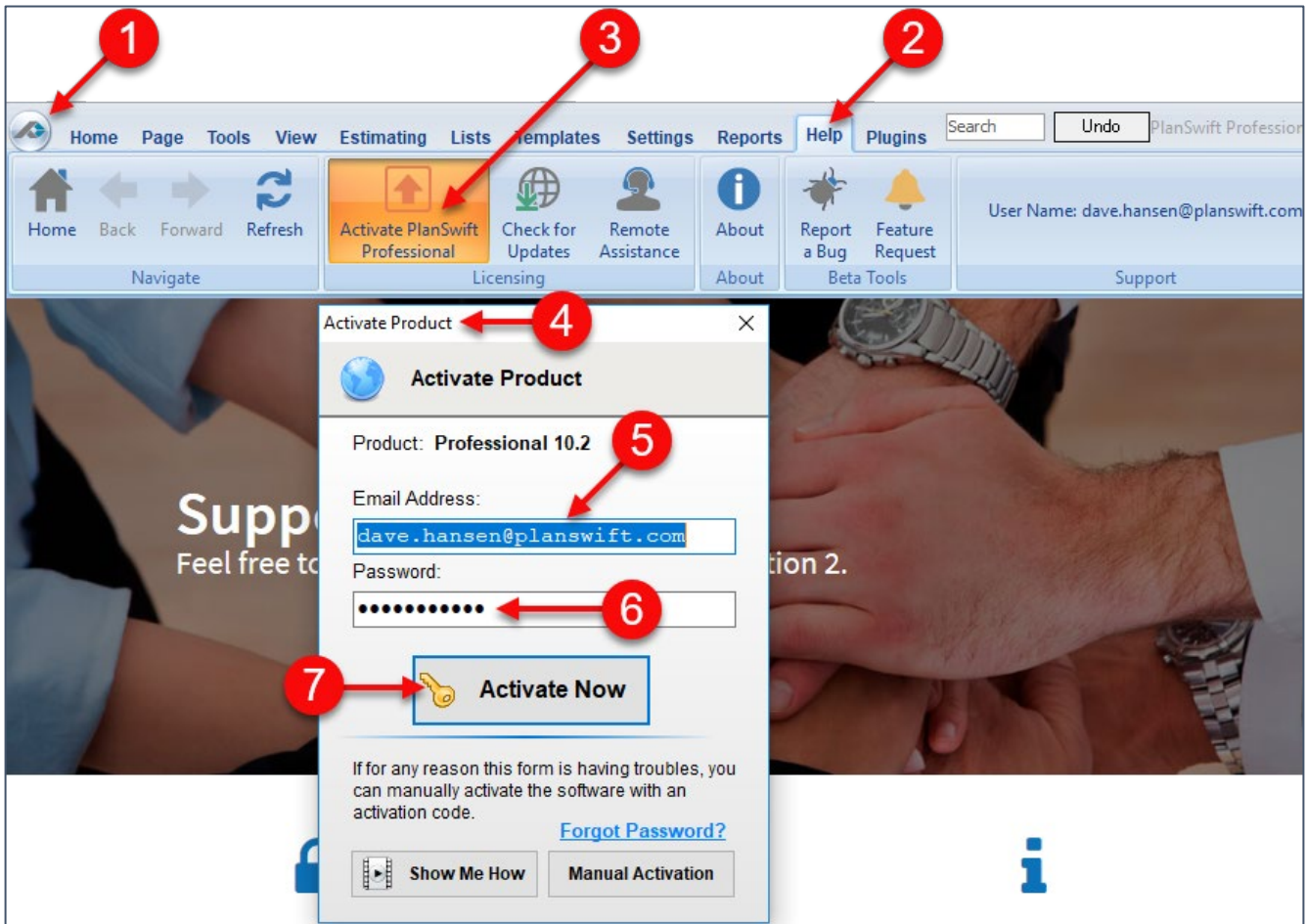

Figure 54-B

8. The **Successfully Activated** window appears upon successful activation (Fig. 54-C). The reactivation date, by default, is ninety days from the day you last activated (although the date could be sooner if you or your account administrator has modified it in [My Account](#)).

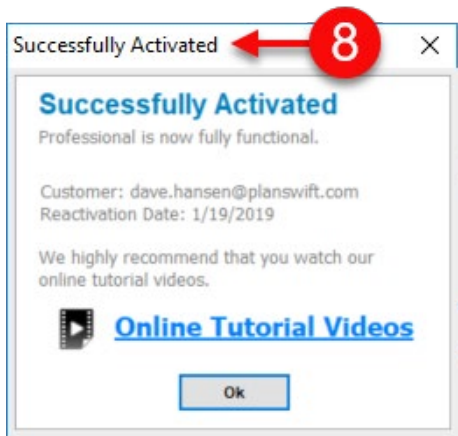

Figure 54-C

9. If your computer is not connected to the internet, then click on the **Manual Activation** button (Fig. 54-B) to open the **Manual Activation** window (Fig. 54-D). You can use another connected device, such as a smart phone, to obtain an activation code.



Figure 54-D

## Removing a PlanSwift License

To remove a PlanSwift license:

1. Click on the **Help** tab on the **Main** tab ribbon-bar (Fig. 54-E).
2. Click on the **Software License Options** button.
3. Select **Remove License** from the drop-down menu.
4. Click on **Ok** in the **Remove Product License** window to remove the license.
5. You are informed that the licensing has been removed from your computer.

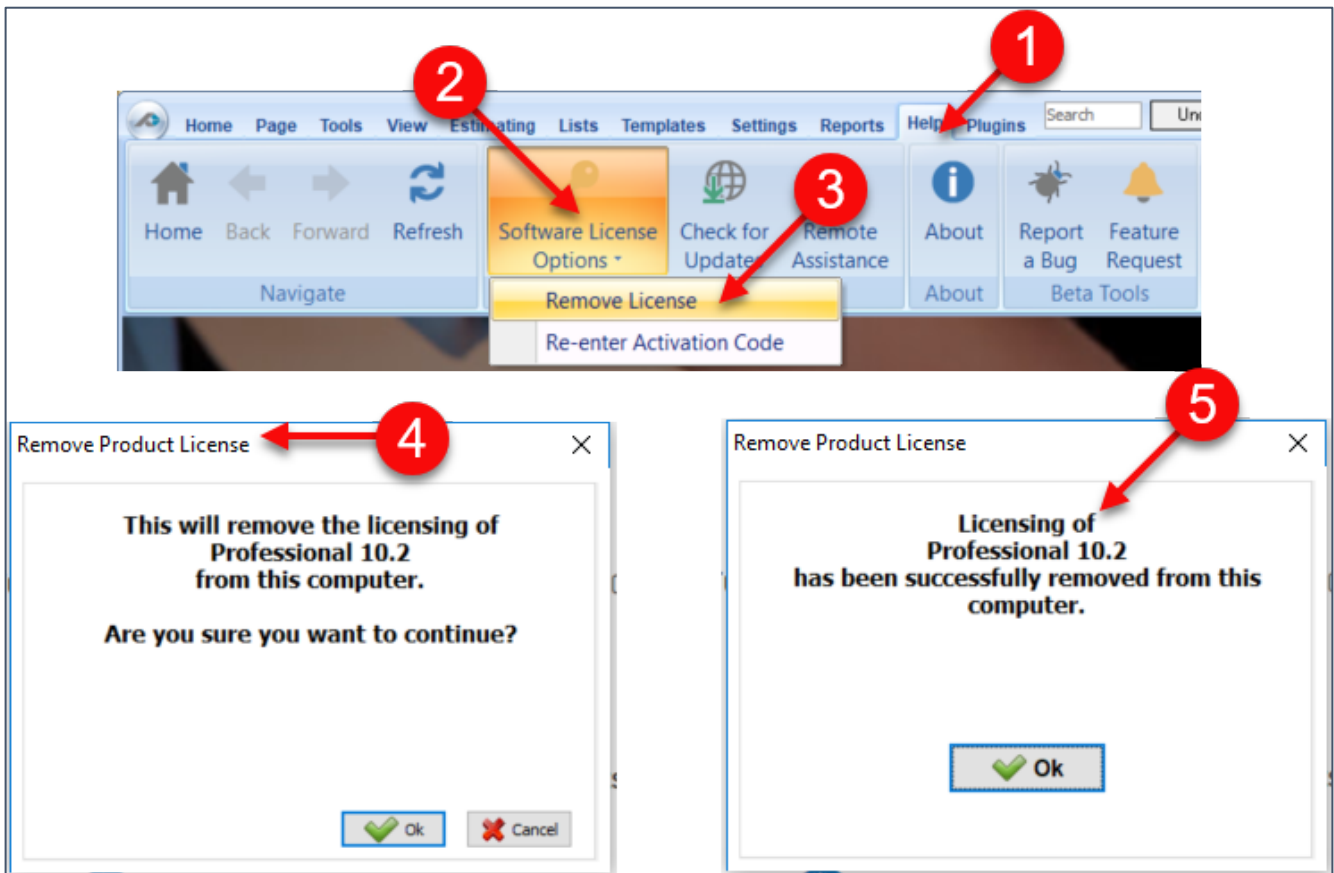

Figure 54-E

To activate PlanSwift on a computer that is in **Viewer** mode, see [Activating PlanSwift](#).

## Automatically Removing a PlanSwift License

If you use PlanSwift on more than one computer, PlanSwift can automatically remove a license when it is closed so that it can then be activated on a different computer. To automatically remove a license, click on the **Settings** tab, click on **General**, and then click on **Automatically remove license when exiting** (Fig. 56-G).

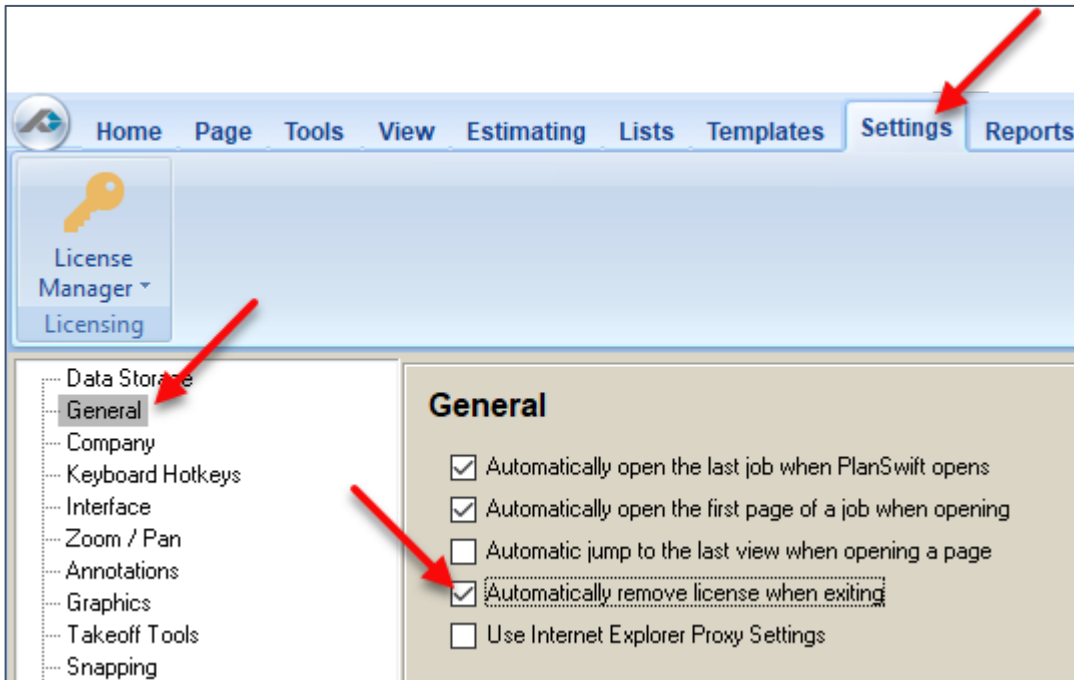

Figure 54-F

## Re-activating, Removing, and Deleting Plugin Licenses

PlanSwift plugin licensing is handled in the **Settings** tab (Fig. 54-G) by clicking the **License Manager**. This opens the **License Manager** window where you can **Re-activate**, **Remove License**, or **Delete** a license. Click on the plugin, then click on the button for what you want to do. Deleting the license does not uninstall the plugin.

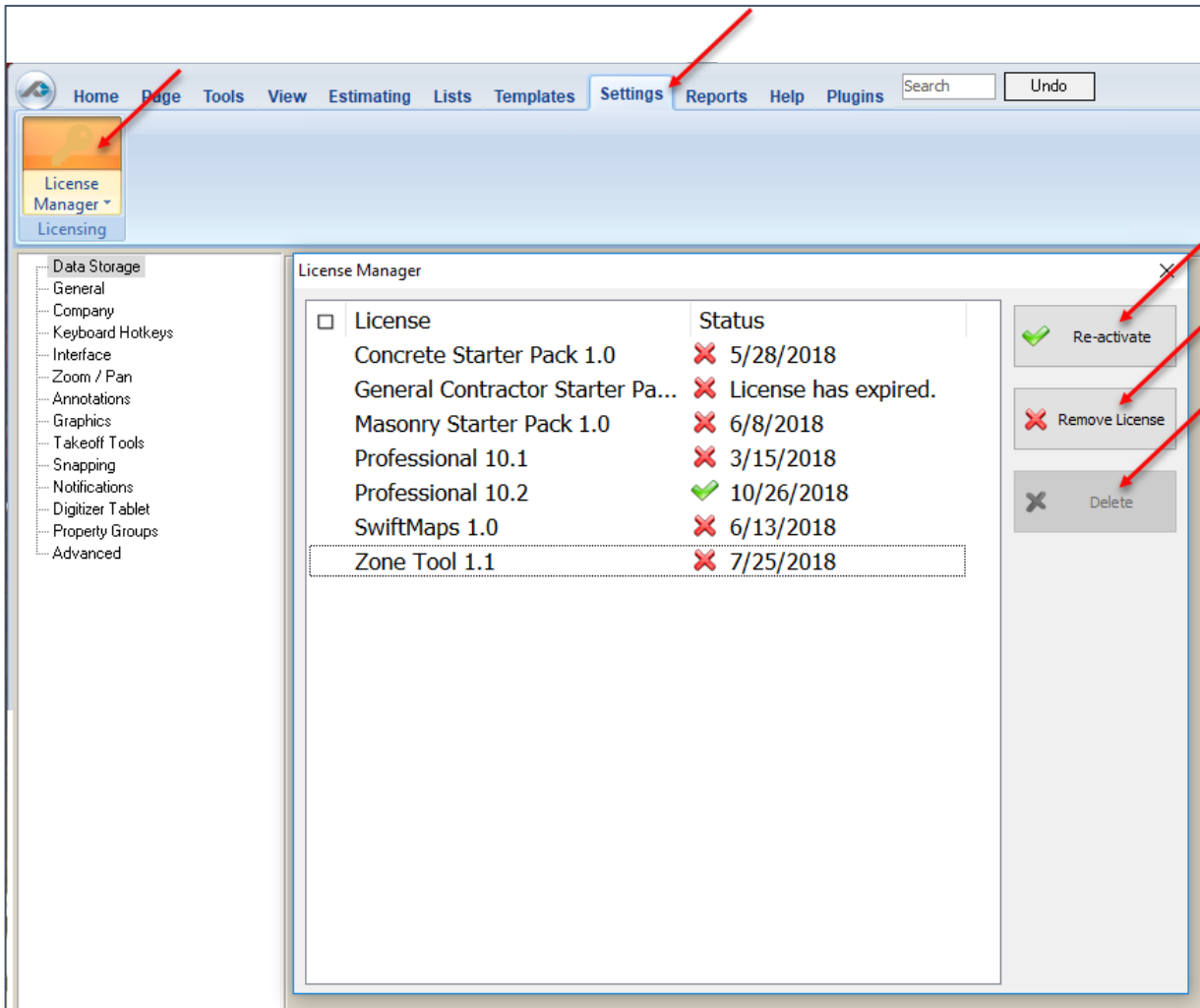

Figure 54-G

# My Account

PlanSwift provides a **My Account** portal to access licensing, support, and company account settings. Click on the **Help** tab on the ribbon-bar menu to display **Support Options** (Fig. 55-A). Click on **My Account** and login (or create an account) to view the **My Account** window.

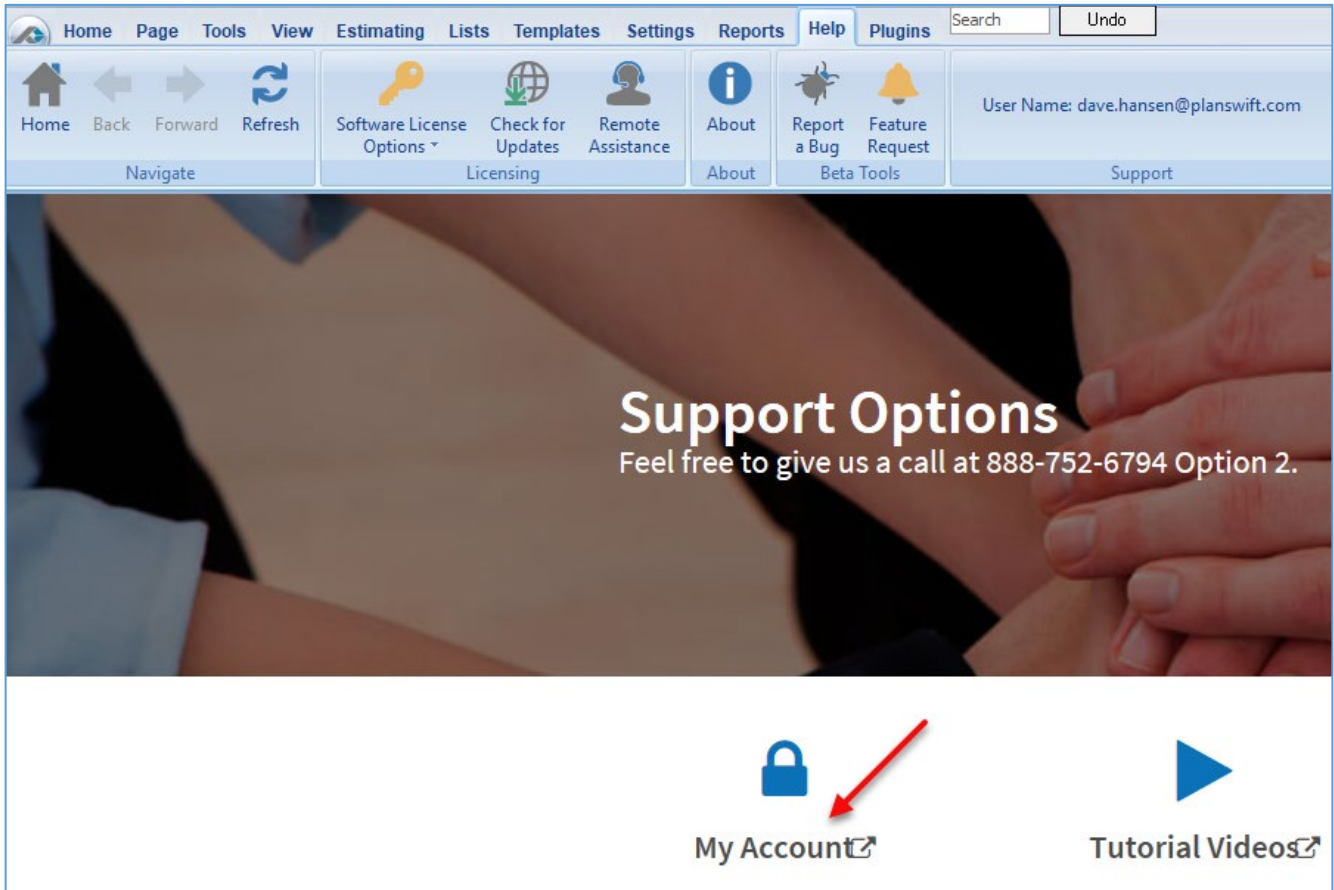

Figure 55-A



The **My Account** window (Fig. 55-B) allows you to access support and view and change your account details and password. The information on licensing is found under **Licenses**.

1. The **Licenses** tab in **My Account** displays the current licenses and activations of your licenses.
2. Click on the **arrow** to view your activations by computer name and by username.
3. Shows the total number of **Seats** in your company.
4. Allows you to **Download** the install file for PlanSwift software.
5. Allows you to temporarily activate PlanSwift in cases where users have forgotten to deactivate the licensing on another installed machine (**Temporary Override** may only be used once per month per company account).

The screenshot shows the PlanSwift My Account interface. At the top, there's a navigation bar with 'Engineering' and 'CustomerID:'. Below that is the PlanSwift logo and a 'LOGOUT' button. The main heading is 'My Account'. On the left is a sidebar with navigation links: Home, Account, My User, All Users, Invoice / Estimates, Order History, Licenses, and Support. The 'Licenses' link is highlighted in red. The main content area shows a message: 'This page will display your licenses! Here you will find all the information needed for all of your PlanSwift licenses, plugins, or Bid Organizer licenses.' Below this is a table of licenses. The first license is 'Professional 10.2 License (Reactivate every 7 days) \*Max 90 days'. It has columns for Description, Type, Expires, Maintenance Expiration, Seats, and Download. A red arrow labeled '2' points to a dropdown arrow next to the license description. A red arrow labeled '3' points to the 'Seats' column (value 10). A red arrow labeled '4' points to the 'Download' column (with a download icon). Below the main license table is a section for 'TEMPORARY OVERRIDE' with a red arrow labeled '5' pointing to it. A red arrow labeled '1' points to the 'Licenses' link in the sidebar.

Description	Type	Expires	Maintenance Expiration	Seats	Download
Professional 10.2 License (Reactivate every 7 days) *Max 90 days	Internal	Jan 19th, 2019	Jan 19th, 2019	10	

Activation Date	Computer Name	User Name	Expiration Date	Activation Type	User:
Jan 3rd, 2018				Jan 10th, 2018	User: @planswift.com
Mar 13th, 2018				Mar 20th, 2018	User: @planswift.com
Mar 23rd, 2018				Mar 30th, 2018	User: @planswift.com
Mar 30th, 2018				Apr 6th, 2018	User: @planswift.com
May 18th, 2018				May 25th, 2018	Pin: CA @planswift.com
Nov 6th, 2018				Jan 19th, 2019	User: @planswift.com
Jan 17th, 2019				Jan 19th, 2019	User: @planswift.com

Figure 55-B

---

## FAQ

**Question:** I've read this User Guide, and I still have questions. What do I do?

**Answer:** We highly recommend new users purchase a training package because training is customized to each user. We offer [one-on-one training](#) and [classroom training](#). Contact [training@PlanSwift.com](mailto:training@PlanSwift.com) or at 1-888-752-6794 Ext. 4.

**Question:** Why is my digitizer stuck in box mode?

**Answer:** The button controlling **Box Mode** is only visible at the bottom of the PlanSwift window when **Digitizer Record** is on (Fig. 56-A). The **Record Mode** button toggles between **Box** and **Point-to-Point** (Fig. 56-B).



Figure 56-A

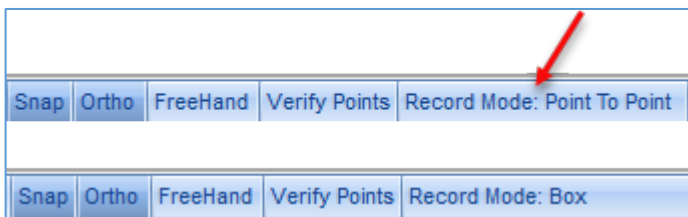

Figure 56-B

**Question:** Why does a **Confirm Dimensions Properties** box keep popping up whenever I am using the **Dimension** tool?

**Answer:** First, check that PlanSwift is activated. Second, if PlanSwift is activated, go to the **Settings** tab on the ribbon-bar menu, click on the **Takeoff Tools** group, and uncheck the **Confirm when recording dimensions** box (Fig. 56-C).

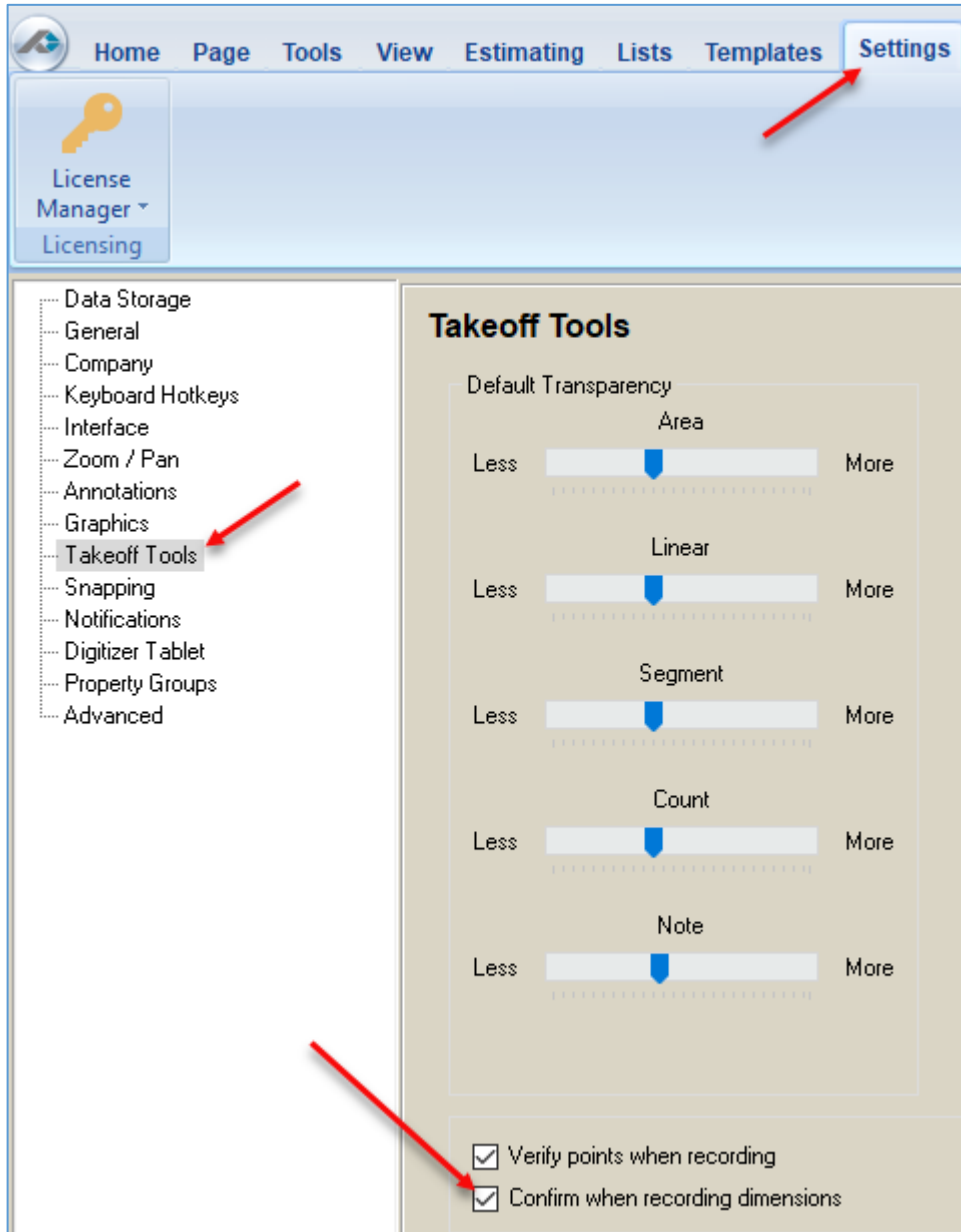

Figure 56-C

**Question:** Why do I get an error message when I try to import PDF drawings?

**Answer:** Go back and try adding the page again using the **Add Pages** feature (Fig. 56-D), and try lowering the DPI (dots per inch) by 50. **The optimum range is 50-300 DPI.** If the problem persists, call Technical Support at 1-888-752-6794 Ext. 2.

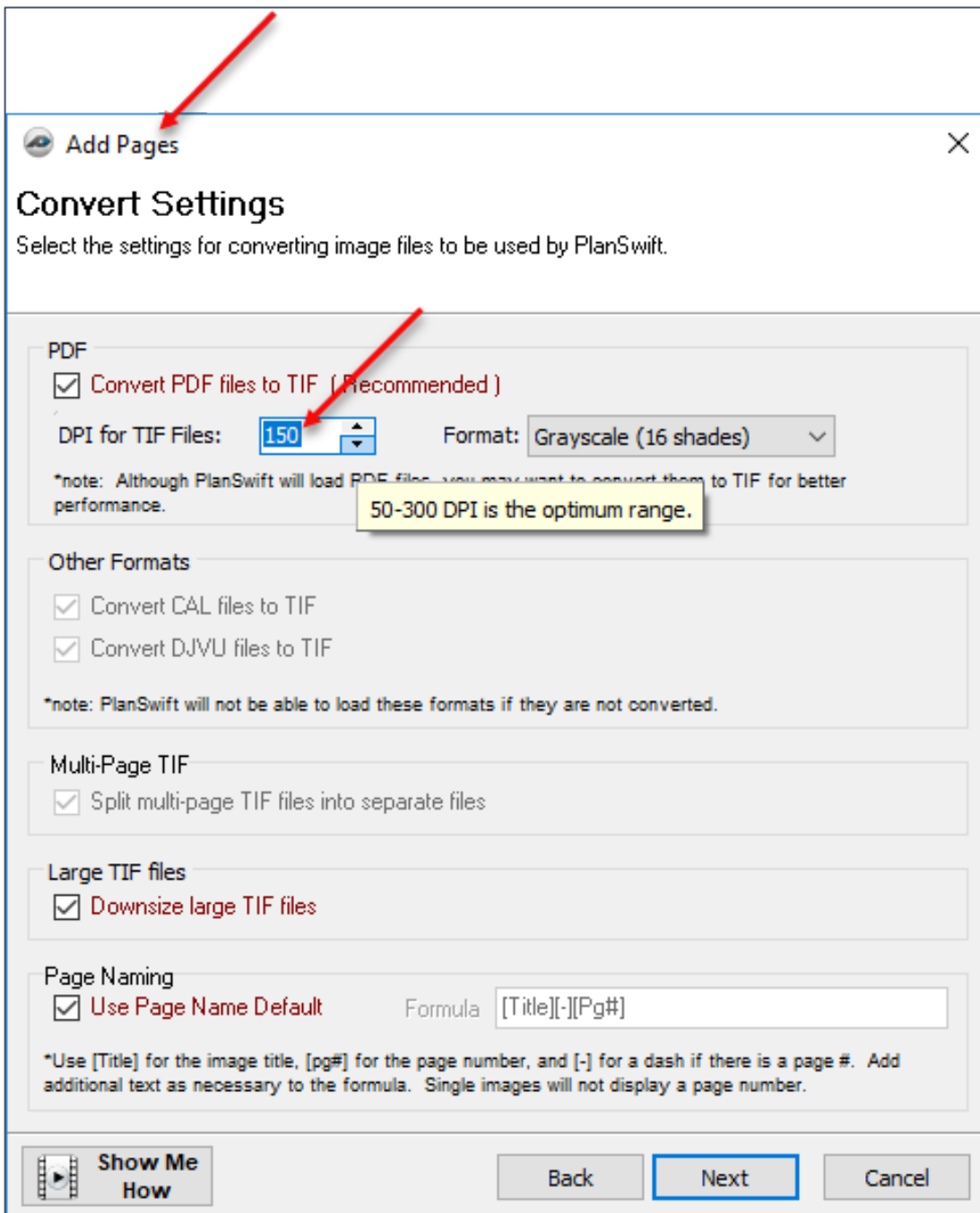

Figure 56-D

**Question:** How do I set a custom scale that is not listed in the drop-down list?

**Answer:** Click on the **Scale** button on the **Home** tab ribbon bar (Fig. 56-E), click on the **Auto** tab in the **Scale** window, select the scale closest to the scale you want. Click in the field with the value and edit it to your custom value.

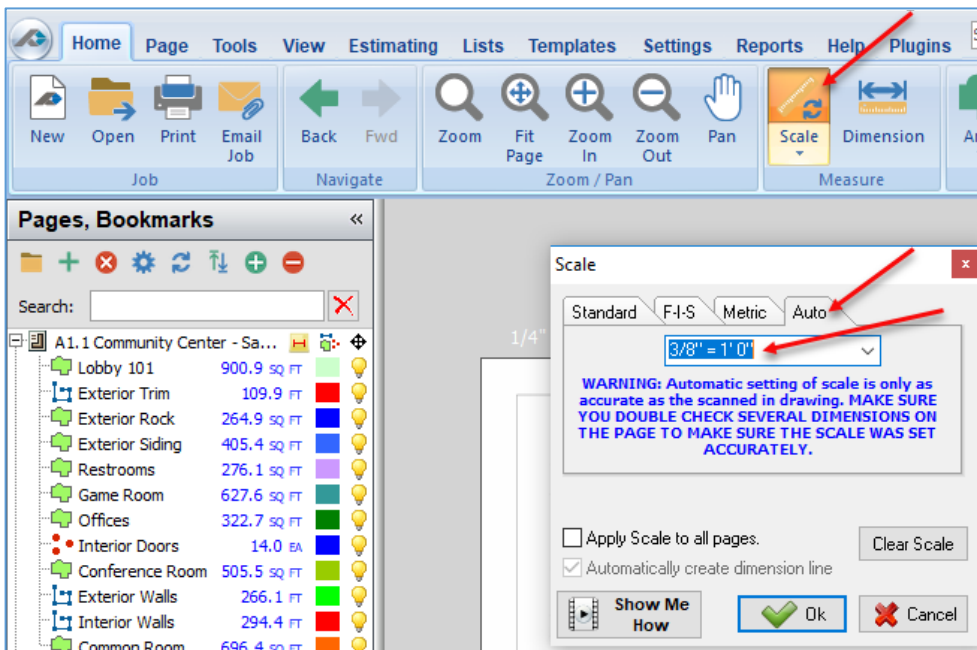

Figure 56-E

**Question:** It seems like PlanSwift has so many features: how does a particular feature apply to me?

**Answer:** PlanSwift is designed to be as basic as you need it to be and powerful enough to grow as your business grows. While a feature may not apply to you directly, knowing the use of the feature may help you in a way you never anticipated. We highly recommend purchasing a training package to discover how particular features can apply to you.

---

**Question:** When I try to activate, I get a message that says: **“No Internet Connection.”**

**Answer:** Manually activating PlanSwift can resolve most issues related to this message (Fig. 56-F). Closing the **No Internet Connection** window opens the **Manual Activation** window (Fig. 56-G). If your computer is not connected to the internet, you can use another connected device, such as a smart phone, to obtain an activation code via a web browser using this **hyperlink**: <https://www.planswift.com/activate>. An [article](#) in PlanSwift’s FreshDesk knowledgebase covers [issues related to PlanSwift’s new activation procedure](#), which was implemented on January 15, 2019.

You can call PlanSwift to obtain an activation code (or to receive assistance) over the phone (888-752-6794, Ext. 2).

If your internet is connected and a firewall is preventing PlanSwift from connecting to the internet, then click on the **hyperlink** (Fig. 56-G) in the **Manual Activation** window and follow the instructions (see Fig. 56-H) from there.

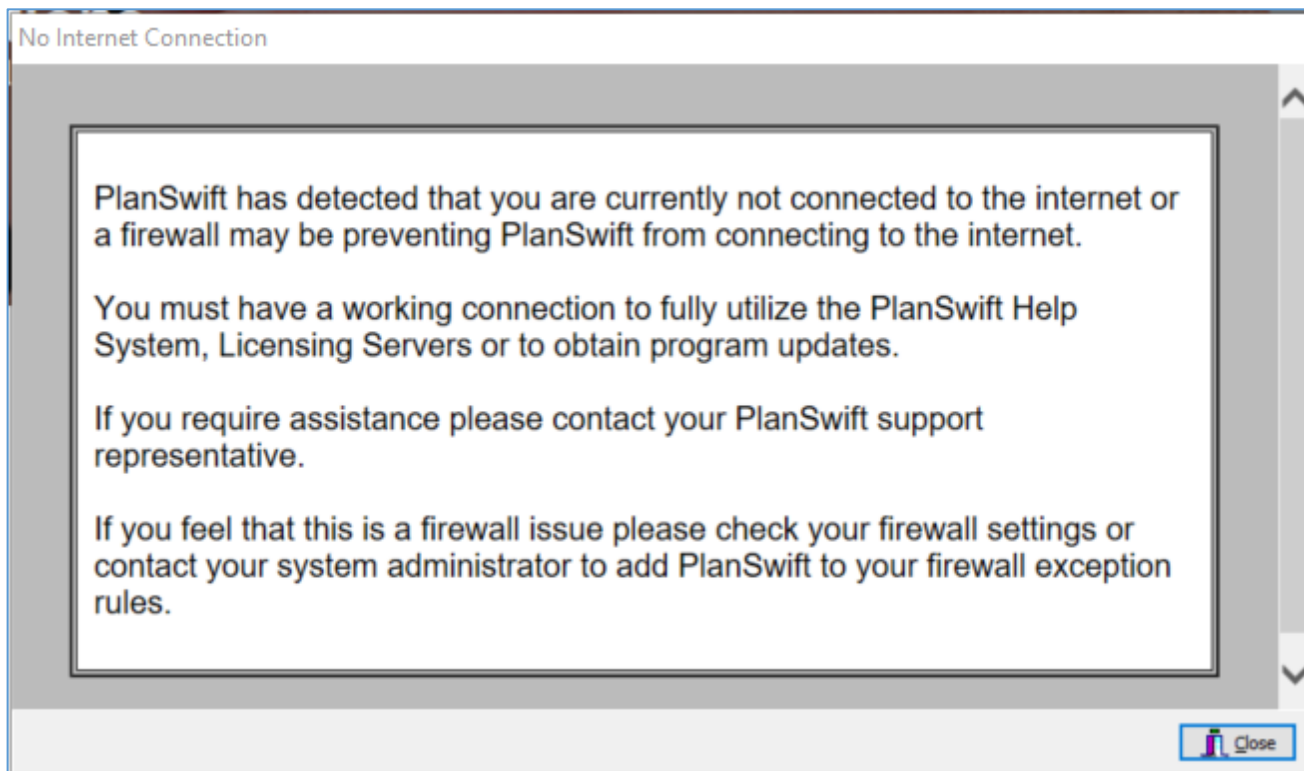

Figure 56-F

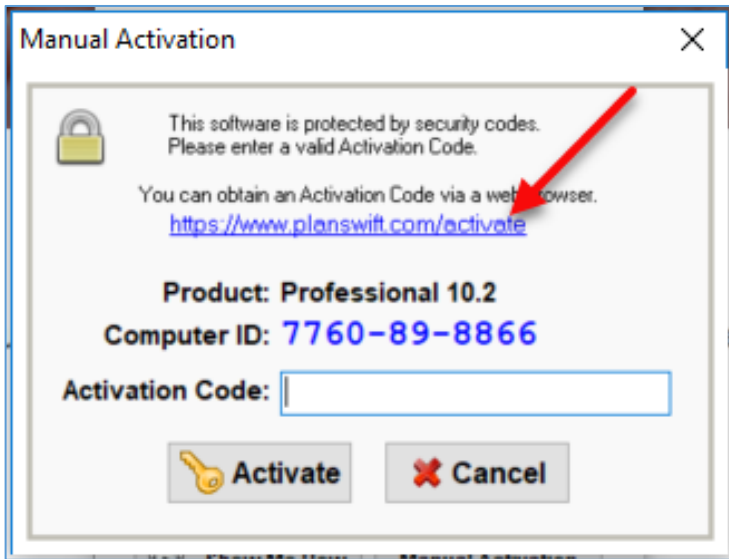

Figure 56-G

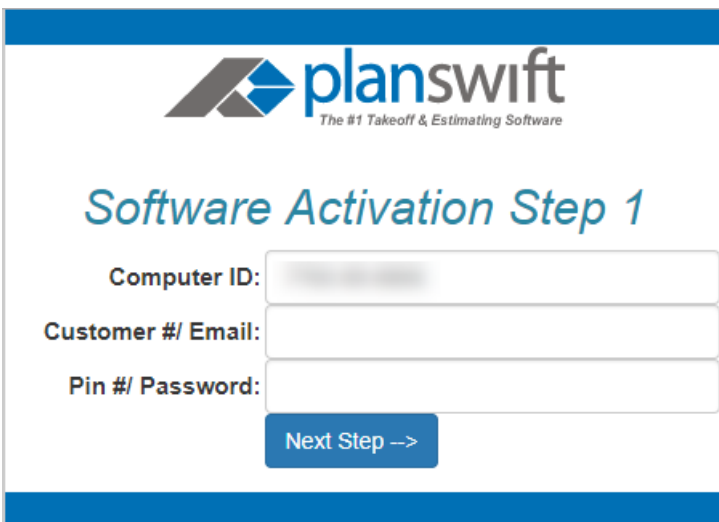

Figure 56-H

**Question:** When I try to activate, I get a “No condition met” message?

**Answer:** First, make sure there are no space characters when entering your customer number. If that isn't the issue, then perform a manual activation (see the FYI question above). Once PlanSwift is activated manually, you may still get a message (when clicking on the Help tab) that there is no internet connection. Restart your computer, and when you're asked if you want to allow PlanSwift to access the internet, click on Yes, and this should resolve the problem.

**Question:** Why can't I activate and use my plugin? A message says the license is active on another computer.

**Answer:** Plugins have their own licensing that needs to be removed from the computer it is activated on and then reactivated on the computer you are using. To remove plugin licensing, click on the **Settings** tab and then **License Manager**. Select the plugin, then click on **Remove License** (Fig. 56-l).

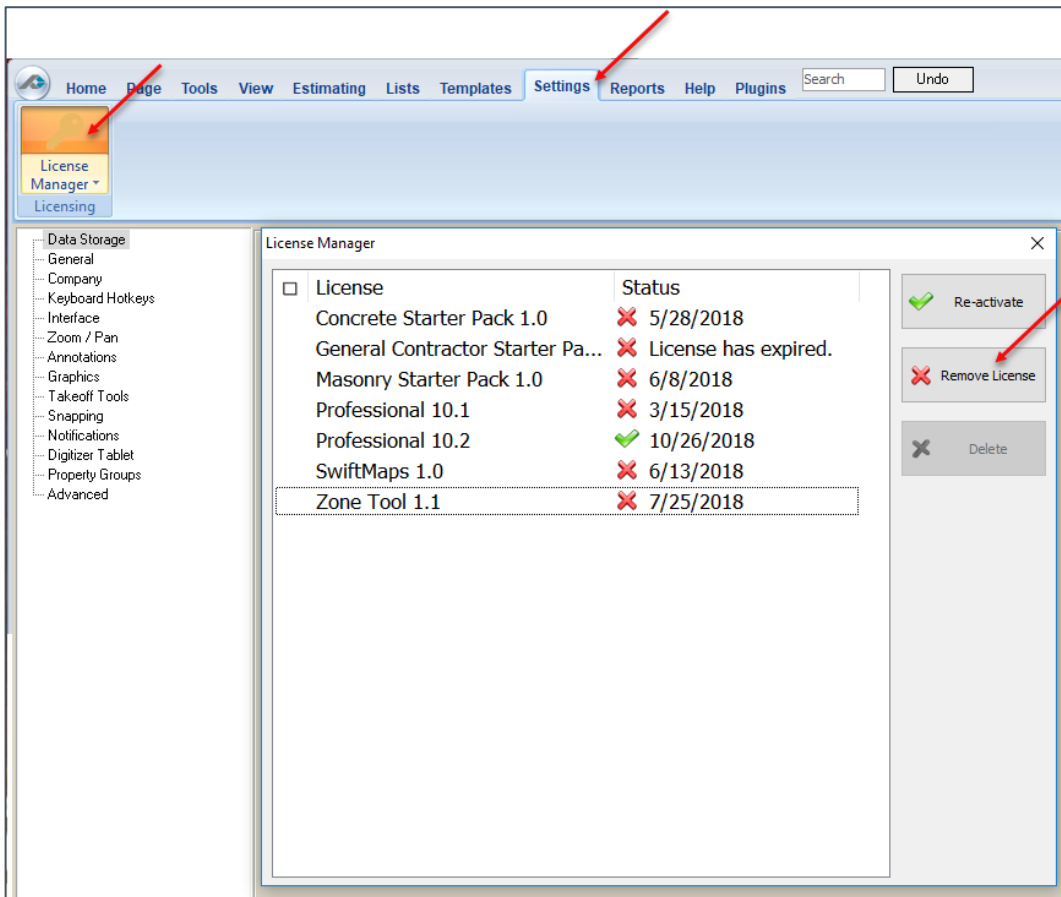

Figure 56-l



**Question:** I keep forgetting to deactivate PlanSwift when I want to switch which computer I am working on. Is there an automatic way of doing this?

**Answer:** Yes. Under **Settings, General**, click on **Automatically remove license when exiting** (Fig. 56-J).

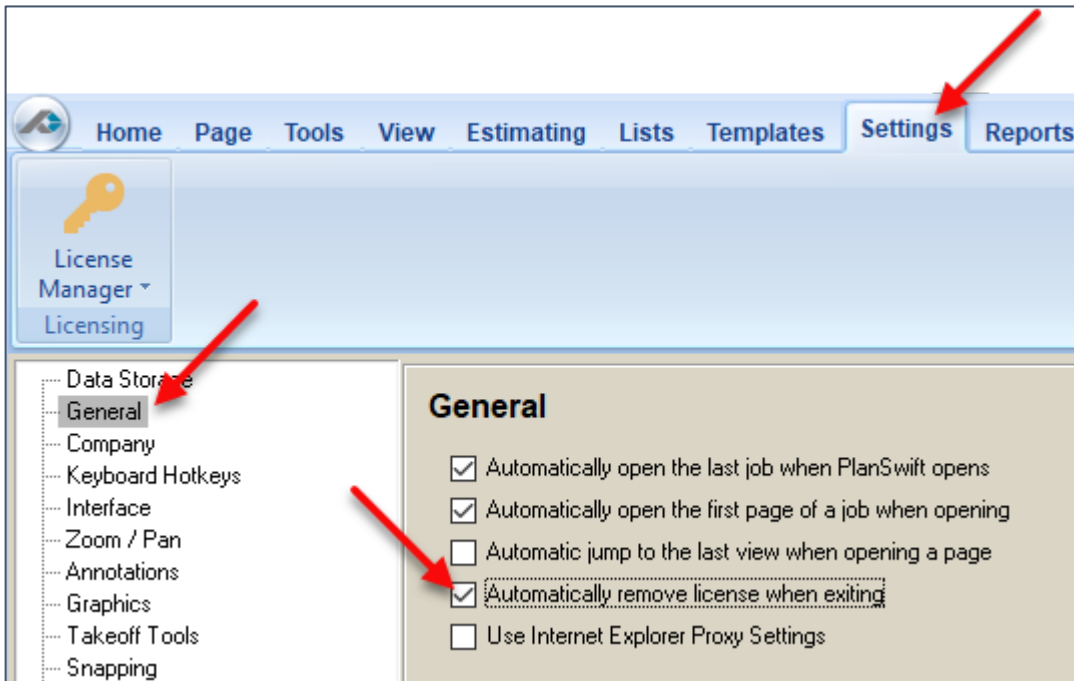

Figure 56-J

**Question:** Why do I get a conversion error?

**Answer:** A conversion error happens when you have an impossible conversion in the **INPUT/OUTPUT Column** on the property. For example, PlanSwift can convert Feet to Inches simply by selecting FT in the Input box, and IN in the Output box, but PlanSwift cannot convert feet to square meters or meters to cubic yards because a dimension is missing.

---

**Question:** Why do I get a loopback error as a result?

**Answer:** A loopback error occurs when you are trying build a formula and you use a property in a loop. For example, if you drag and drop the QTY property into the Cost Each property and then drag the Cost Each property back into the QTY property, that would result in a loop.

**Question:** Why do I get a syntax error as a result?

**Answer:** A syntax error usually occurs because of an incorrect character or characters in the **Formula Box**. For example, if you left off a bracket [ ] when trying to inherit a property,  $([Area]/([Length * [Width]))$ , or if your formula had two multiply signs  $([Area]/([Length] ** [Width]))$ , both of those would result in a syntax error.